

3

Urban Stormwater Retrofit Practices

Version 1.0



August 2007

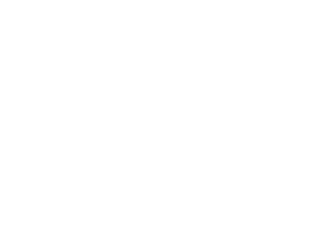
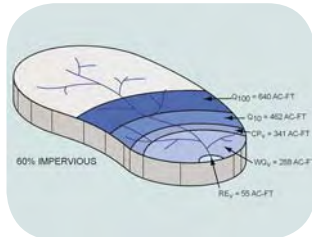
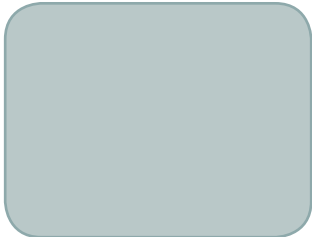

Urban Subwatershed Restoration Manual No. 3

URBAN STORMWATER RETROFIT PRACTICES

Version 1.0

Prepared by:

Tom Schueler, David Hirschman, Michael Novotney, and Jennifer Zielinski, P.E.
Center for Watershed Protection
8390 Main Street, 2nd Floor
Ellicott City, MD 21043
www.cwp.org
www.stormwatercenter.net



Prepared for:
Office of Wastewater Management
U.S. Environmental Protection Agency
Washington, D.C.

July 2007

Copyright© 2007 by the Center for Watershed Protection.
Material may be quoted provided credit is given.
Printed in the United States of America on recycled paper.

Foreword

Writing this manual has been a labor of love for many current and former Center staff who have been involved in urban retrofitting in dozens of urban watersheds over the past few decades. The experience we have gained in Sligo Creek, the Kensico Reservoir, Longwell Branch, the Bronx River, Little Lick Creek, Watts Branch, Powhatan Creek, Watershed 263, and many other small watersheds have enabled us to develop and refine better methods to find, design and build retrofits faster and more cost-effectively. This manual outlines our most recent ideas on how retrofits can help restore small urban watersheds.

This manual could not have been written without the help of many retrofit experts. Special thanks are extended to Ted Brown, P.E. (Biohabitats, Inc.), Rich Claytor, P.E. (Horsley Witten Group) and Tim Schueler, P.E. (McKim and Creed) for their ongoing input on the art and science of retrofitting over the past five years. I am also indebted to current Center staff that contributed their hard won experience and knowledge to the effort: Jennifer Zielinski, Dave Hirschman, Mike Novotney and Sally Hoyt. Lisa Fraley-McNeal deserves special thanks for her great retrofit artwork and for updating our national pollutant removal database. Most of all, I am grateful to Tiffany Wright for her tireless work and dedication to quality in producing this manual and seven others in the Urban Subwatershed Restoration Manual Series.

The technical content and readability of the manual were greatly improved due to the insightful comments of Rich Claytor, Tim Schueler, Ted Brown, Dan Harper (Montgomery County DEP), and Dave Hirschman.

Also, since retrofitting is about envisioning the prospects for restoration, we want to credit the many individuals who provided photos to help visualize the process, including Lincoln Kan, City of Mississauga, Ontario; Dr. Bill Hunt, North Carolina State University; Gary Oberts, EOR, Inc.; Tim Schueler, McKim and Creed; Derek Booth, Stillwater Sciences; Roger Bannerman, Wisconsin DNR; Tom Liptan, Portland Bureau of Environmental Services; Rich Claytor, Horsley Witten Group; Martin Covington, Carroll County, MD; Sonal Sanghavi, MD State Highway Administration; Seattle SEA Streets program; and the staff of the Center for Watershed Protection.

Thanks are also due to our EPA project officer, Bryan Rittenhouse, for his support during the two years it took to produce this manual under a cooperative agreement with U.S. EPA Office of Wastewater Management (CP-83276401).

In closing, I hope our readers discover how much fun it can be to embark on the search for storage and build retrofits that improve watershed health. Good hunting!

Sincerely,



Tom Schueler
Director of Watershed Practices

About the Restoration Manual Series

Over the last four years, the Center for Watershed Protection has produced a series of 11 manuals that describes the techniques to restore small urban watersheds. The entire series of manuals was written to organize the enormous amount of information needed to restore small urban watersheds into a format that can easily be accessed by watershed groups, municipal staff, environmental consultants and other users. The contents of the manuals are organized as follows:

Manual 1: An Integrated Framework to Restore Small Urban Watersheds

The first manual, published in 2004, introduces the basic concepts and techniques of urban watershed restoration, and sets forth the overall framework we use to evaluate subwatershed restoration potential. The manual emphasizes how past subwatershed alterations must be understood in order to set realistic expectations for future restoration. Toward this end, the manual presents a simple subwatershed classification system to define expected stream impacts and restoration potential. Next, the manual defines seven broad groups of restoration practices, and describes where to look in the subwatershed to implement them. The manual concludes by presenting a condensed summary of a planning approach to craft effective subwatershed restoration plans.

Manual 2: Methods to Develop Restoration Plans for Small Urban Watersheds

The second manual was published in 2005 and contains detailed guidance on how to put together an effective plan to restore urban subwatersheds. The manual outlines a practical, step-by-step approach to develop, adopt and implement a subwatershed plan in your community. Within each step, the manual

describes 32 different desktop analysis, field assessment, and stakeholder involvement methods used to make critical restoration management decisions.

Manual 3: Urban Stormwater Retrofit Practices

This manual, published in 2007, focuses on stormwater retrofit practices that can capture and treat stormwater runoff before it is delivered to the stream. The manual describes both off-site storage and on-site retrofit techniques that can be used to remove stormwater pollutants, minimize channel erosion, and help restore stream hydrology. Guidance on choosing the best locations in a subwatershed for retrofitting is provided in a series of 13 profile sheets. The manual then presents a method to assess retrofit potential at the subwatershed level, including methods to conduct a retrofit inventory, assess candidate sites, screen for priority projects, and evaluate their expected cumulative benefit. The manual concludes by offering tips on retrofit design, permitting, construction, and maintenance considerations.

Manual 4: Urban Stream Repair Practices

The fourth manual was published in 2005 and concentrates on practices used to enhance the appearance, stability, structure, or function of urban streams. The manual offers guidance on three broad approaches to urban stream repair – stream cleanups, simple repairs, and more sophisticated comprehensive repair applications. The manual emphasizes the powerful and relentless forces at work in urban streams, which must always be carefully evaluated in design. Next, the manual presents guidance on how to set appropriate restoration goals for your stream, and how to choose the best combination of stream repair practices to meet them.

The manual also outlines methods to assess stream repair potential at the subwatershed level, including basic stream reach analysis, more detailed project investigations, and priority screenings. The manual concludes by offering practical advice to help design, permit, construct and maintain stream repair practices in a series of more than 30 profile sheets.

Manual 5: Riparian Management Practices

This manual was originally envisioned to provide guidance on how to restore the quality of forests and wetlands in the stream corridor, though it was never officially completed. The Center completed several manuals from 2005 to 2007 that fully address this topic including the three parts of the *Urban Watershed Forestry Manual* and the six *Wetlands and Watersheds* articles produced for USDA and U.S. EPA, respectively.

Manual 6: Discharge Prevention Practices

The sixth manual covers practices used to prevent the entry of sewage and other pollutant discharges into the stream from pipes and spills. The manual describes a variety of techniques to find, fix and prevent these discharges that can be caused by illicit sewage connections, illicit business connections, failing sewage lines, or industrial/transport spills. The manual also briefly presents desktop and field methods to assess the severity of illicit discharge problems in your subwatershed. Lastly, the manual profiles different “forensic” methods to detect and fix illicit discharges. The Center never completed the full manual, but a major portion of the topic is covered in a 2004 manual entitled *Illicit Discharge Detection and Elimination: A Guidance Manual for Program Development and Technical Assessments* (Brown *et al.*, 2004)

Manual 7: Watershed Forestry Practices

The seventh manual reviews subwatershed practices that can improve the quality of upland pervious areas, which include techniques to improve conditions, revegetate pervious areas, and restore natural area remnants. When broadly applied, these techniques can improve the capacity of these lands to absorb rainfall and sustain healthy plant growth. This manual also outlines methods to assess the potential for these techniques at both the site and subwatershed scale. This manual was published under separate cover as the *Urban Watershed Forestry Manuals*.

Manual 8: Pollution Source Control Practices

Pollution source control practices reduce or prevent pollution from residential neighborhoods or stormwater hotspots. Thus, the topic of the eighth manual is a wide range of stewardship and pollution prevention practices that can be employed in subwatersheds. The manual presents several methods to assess subwatershed pollution sources in order to develop and target education and/or enforcement efforts that can prevent or reduce polluting behaviors and operations. The manual outlines more than 100 different “carrot” and “stick” options that can be used for this purpose. Lastly, the manual presents profile sheets that describe 21 specific stewardship practices for residential neighborhoods, and 15 pollution prevention techniques for control of stormwater hotspots.

Manual 9: Municipal Good Housekeeping Practices

The ninth manual, published in 2007, focuses on how municipal operations can directly support subwatershed restoration efforts. The manual contains a municipal operations analysis to help local stormwater managers target the municipal operations and activities that can improve water quality. The 10 areas include municipal hotspots, municipal construction, road maintenance, street sweeping, storm drain cleanouts, stormwater hotlines, landscaping and park maintenance, residential stewardship, stormwater maintenance, and employee training. The manual presents guidance on how municipalities can modify these 10 programs to promote subwatershed restoration goals. It presents a series of profile sheets that recommends specific techniques to implement effective municipal programs.

Manual 10: The Unified Stream Assessment (USA): A User's Manual

The Unified Stream Assessment (USA) is a rapid technique to locate and evaluate problems and restoration opportunities within the urban

stream corridor. The tenth manual is a user's guide that describes how to perform the USA, and interpret the data collected to determine the stream corridor restoration potential for your subwatershed.

Manual 11: The Unified Subwatershed and Site Reconnaissance (USSR): A User's Manual

The last manual examines pollution sources and restoration potential within upland areas of urban subwatersheds. The manual provides detailed guidance on how to perform each of its four components: the Neighborhood Source Assessment (NSA), Hotspot Site Investigation (HSI), Pervious Area Assessment (PAA) and the analysis of Streets and Storm Drains (SSD). Together, these rapid surveys help identify upland restoration projects and source control to consider when devising subwatershed restoration plans.

Table of Contents

Table of Contents

Foreword	i
About the Manual Series.....	iii
Table of Contents	vii
Chapter 1: Basics of Stormwater Retrofitting.....	1
1.1 Why Retrofitting is Different	2
1.2 Restoration Objectives for Stormwater Retrofits	2
1.3 Rainfall, Runoff and Retrofits	5
1.4 The Search for Subwatershed Storage	11
1.5 The Range of Retrofit Practices	13
1.6 Basic Steps in Stormwater Retrofitting	16
1.7 Stormwater Treatment Options for Retrofitting	18
1.8 Retrofit Economics.....	19
1.9 Strategies to Deliver Retrofit Projects at the Subwatershed Level.....	21
Chapter 2: 13 Subwatershed Locations Near You.....	27
SR-1 Modify Existing Ponds	31
SR-2 Storage Above Roadway Crossings	45
SR-3 New Storage Below Outfalls	57
SR-4 Treatment in the Conveyance System	69
SR-5 Storage in Transport Rights-of-Way	81
SR-6 Large Parking Lot Retrofits.....	89
OS-7 Hotspot Operations	95
OS-8 Small Parking Lot Retrofits	103
OS-9 Individual Streets	113
OS-10 Individual Rooftops.....	125
OS-11 Little Retrofits.....	135
OS-12 Landscapes/Hardscapes	143
OS-13 Underground Retrofits.....	149
Chapter 3: Stormwater Treatment Options for Retrofitting	155
ST-1 Extended Detention.....	159
ST-2 Wet Ponds.....	163
ST-3 Constructed Wetlands	167
ST-4 Bioretention.....	171
ST-5 Filtration	175
ST-6 Infiltration	181
ST-7 Swales.....	185
ST-8 Other Retrofit Treatment.....	189
Chapter 4: The Search for Subwatershed Storage – Finding Retrofit Opportunities at the Subwatershed Level.....	191
Step 1: Retrofit Scoping	192

Table of Contents

Step 2: Desktop Retrofit Analysis..... 199

Step 3: Retrofit Reconnaissance Investigation 204

Step 4: Compile Retrofit Inventory..... 222

Step 5: Retrofit Evaluation and Ranking 226

Step 6: Subwatershed Treatment Analysis 231

Step 7: Final Design and Construction 232

Step 8: Inspection, Maintenance and Evaluation..... 237

References R-1

Appendix A: Retrofit Reconnaissance Investigation Form and Retrofit Field Guide Template A-1

Appendix B: Defining Retrofit Pollutant Load Reduction..... B-1

Appendix C: Deriving the Channel Protection Storage Volume..... C-1

Appendix D: Retrofit Pollutant Removal Rates..... D-1

Appendix E: Derivation of Unit Costs for Stormwater Retrofits & New Stormwater Treatment Construction E-1

Appendix F: Rooftop Retrofit Design Sheets F-1

Appendix G: Example Concept Design G-1

Appendix H: Infiltration Testing Procedures..... H-1

Appendix I: Retrofit Design Sheets I-1

Chapter 1: Basics of Stormwater Retrofits

Stormwater retrofits help restore watersheds by providing stormwater treatment in locations where practices previously did not exist or were ineffective. They are typically installed within the stream corridor or upland areas to capture and treat stormwater runoff before it is delivered to receiving waters. Retrofits are the primary practice used to restore subwatersheds since they can remove pollutants, promote more natural hydrology and minimize stream channel erosion. This manual provides detailed guidance on how to effectively retrofit subwatersheds.

This chapter introduces the basics of stormwater retrofits and how they are integrated with other restoration practices to meet subwatershed objectives. Nine sections guide the design team through the search for storage by answering the following questions:

- 1.1 How is retrofitting different from traditional stormwater design?
- 1.2 What restoration objectives can be achieved by subwatershed retrofitting?
- 1.3 How much stormwater storage is needed in the retrofits to meet objectives?
- 1.4 How much storage can be found in a subwatershed to achieve this target?
- 1.5 What subwatershed locations are most suited for retrofit sites?
- 1.6 What stormwater treatment options best meet restoration objectives?
- 1.7 What desktop and field methods are needed to systematically find them?
- 1.8 How much does it cost to retrofit an entire subwatershed?

- 1.9 What are the best strategies to deliver multiple retrofits across a subwatershed?

Chapter 2 describes 13 different locations in a subwatershed where retrofitting may be possible. A profile sheet describes each retrofit location and presents tips on how to find candidate sites using desktop searches and how to assess them in the field. The individual profile sheets provide guidance on permitting, design, construction and delivery issues and outline methods to estimate retrofit construction costs.

Chapter 3 briefly reviews the eight major stormwater treatment options that can be employed in stormwater retrofits and presents a technique to estimate pollutant reduction at individual retrofit sites.

Chapter 4 describes how to systematically assess retrofit potential at the subwatershed level and the individual site. The chapter outlines an eight-step process to guide designers through initial retrofit scoping to final construction. Methods are presented to identify candidate sites in a subwatershed that have the greatest potential for retrofitting. The chapter describes how to perform a Retrofit Reconnaissance Investigation to generate the most feasible sites. Guidance is also provided on how to develop and rank initial concept designs for retrofit projects, and create a subwatershed retrofit inventory. The chapter concludes with general tips to support final retrofit design, construction, maintenance and evaluation.

This manual should be read in the context of several others in the *Urban Subwatershed Restoration Manual Series*, particularly:

- No. 1 An Integrated Framework to Restore Small Watersheds
- No. 2 Methods to Develop Restoration Plans for Small Urban Watersheds
- No. 4 Urban Stream Repair Practices
- No. 7 Watershed Forestry Practices
- No. 8 Pollution Source Control Practices

1.1 Why Retrofitting is Different

Most retrofit designers have some prior experience designing new stormwater practices. It is important, however, to note the many ways that retrofit design differs from the design of new stormwater treatment practices (Table 1.1). Retrofitting requires a different way of thinking; it requires sleuthing skills to determine what can work at highly constrained sites. Designers need to simultaneously envision restoration possibilities and anticipate potential problems. Designers must be extremely creative to find and design effective stormwater solutions within the built environment that produce desired subwatershed results.

The design, permitting and construction of retrofits are almost always more complex, expensive and time consuming than new stormwater practices. Also, since most projects are sponsored by the public sector, they must meet high standards for performance, community benefit and appearance. Designers should seek to maximize restoration objectives and not merely design toward a rule. The ethical bar for retrofit design is also higher – designers must ensure that their proposed retrofit adds to watershed function and does not impair existing wetlands, streams and forests. The

goal is not just to get approval for a development project or secure a stormwater permit, but rather to create a project that will look good, perform well for many decades, and have a reasonable maintenance burden.

1.2 Restoration Objectives for Stormwater Retrofits

The retrofit process begins with a diagnosis of how subwatershed development is currently degrading stream quality. The reader should consult Manual 1 for an extended discussion of the Impervious Cover Model and how it can be used to diagnose the severity of problems in a subwatershed and determine restoration potential.

Setting restoration objectives early in the retrofitting process is extremely important. Restoration objectives define the purpose of retrofitting and target the specific subwatershed problems to be solved. A good set of restoration objectives helps identify what pollutants need to be treated, how much storage is needed and where the most cost-effective locations are in the subwatershed. Communities around the country have chosen many different restoration objectives to guide their retrofitting efforts, as described below.

Fix Past Mistakes & Maintenance Problems: Traditionally, communities have used retrofits to improve their existing stormwater infrastructure (e.g., to fix drainage problems, deal with under-sized culverts, protect water and sewer lines threatened by erosion or to address chronic maintenance problems within individual stormwater practices). These infrastructure retrofits are localized to address a specific problem and are seldom done on a subwatershed-wide basis. The type of

Table 1.1: Why Retrofitting is Different from New Stormwater Design	
Urban Retrofit Practices	New Stormwater Practices
Construction costs are 1.5 to 4 times greater	Designers seek least costly options
Requires significant data collection	Much of the data may be borrowed from past designs
Assessment and design costs are higher	Focus on low cost design and construction
Sized to meet subwatershed restoration objectives (or best one can do)	Sized to meet local stormwater design standards
Typically installed on public land	Installed at new development projects
Urban soils often cannot support infiltration	Soils may support infiltration
Fingerprinted around existing development and infrastructure	More flexibility on where to locate practices on the site
Must be acceptable to adjacent neighbors and landowners	Aesthetics are not always a major design factor
Most are publicly maintained and the public expects that they will be	Most require private maintenance, which is not frequently performed
Not all candidate sites are feasible	Nearly all sites are made to work
Often tied into existing stormwater conveyance system	Usually creates the new stormwater conveyance system
Integrated with other restoration practices	Stand-alone practice
Public investment in watershed infrastructure	Private investment in stormwater infrastructure
Site visit is prerequisite for design	Design may occur without site visit

storage usually is tailored to solve the specific problem at the site.

Solve Chronic Flooding Problems: Another common retrofit objective is to solve flooding problems at vulnerable locations within a subwatershed. This retrofitting approach focuses on specific reaches or flood prone areas. Upstream storage retrofits may be investigated to reduce flood damage in subwatersheds that were developed prior to local stormwater or floodplain management requirements. These large retrofits are sized to provide storage for extreme flood events (e.g., 25 to 100 year peak discharge control).

Stormwater Demonstration and Education: Many communities embark on retrofitting to demonstrate new stormwater practices on public lands or promote stormwater

education and stewardship. As a result, demonstration retrofits are installed on a localized rather than subwatershed-wide basis. Most demonstration retrofits are sized to treat the water quality volume and introduce new stormwater technologies. Well-designed and highly visible demonstration retrofits are a good tactic to garner greater support to finance more widespread retrofitting efforts in the future.

Trap Trash and Floatables: The objective for these retrofits is to keep trash and floatables out of receiving waters. The basic approach combines pollution prevention, storage retrofits and improved catch basins to trap trash and floatables before they enter receiving waters. Since trash is fairly easy to trap, most retrofits are sized based on a fraction of the water quality volume, although they typically require intensive maintenance after every major storm event. Retrofit programs to reduce trash have been

conducted in diverse cities such as New York City, Los Angeles, Baltimore, Albuquerque, and the District of Columbia.

Reduced Runoff Volumes to Combined Sewers: In recent years, communities have recognized that on-site retrofits can greatly reduce stormwater inputs to combined sewers, thereby reducing the frequency and size of sewage overflows in urban subwatersheds. This retrofit strategy can greatly reduce the size and cost of traditional combined sewer overflow (CSO) abatement systems such as deep tunnels or storage pipes. In many cases, on-site retrofits only need to reduce a fraction of the water quality volume to become a cost-effective technique to reduce CSOs. Rooftop treatment or disconnection is the most common approach to reduce runoff volumes, and they have been applied in diverse settings such as Philadelphia, Pittsburgh, Portland, Milwaukee, and the District of Columbia.

Renovate the Stream Corridor: This objective focuses on installing retrofits to improve the quality of a stream corridor, whether it is a greenway, stream valley park or chain of wetlands or lakes. The retrofits are located in or near the stream corridor, and are intended to improve water quality, create wetland and wildlife habitat, daylight urban streams, naturalize the stream corridor or demonstrate creative stormwater practices. Some progressive communities that have utilized retrofits to renovate the stream corridor include the Staten Island Bluebelt, Minnehaha Creek in Minneapolis, and the Rouge River in Michigan.

Reduce Pollutants of Concern: Pollutant reduction is often a primary objective of local retrofit programs. The reduction may be driven by a TMDL, a local watershed restoration plan or regional directive to reduce pollutant loads. The pollutant of

concern may include sediment, nutrients, bacteria, metals and toxins. Retrofits are then systematically applied across a subwatershed to achieve a pre-designated pollutant reduction goal. Retrofits are typically sized based on a target water quality volume, although individual retrofits may be under or over-sized. Examples of communities that have retrofit subwatersheds to maximize pollutant removal include the Staten Island Bluebelt, communities in Maryland; North Carolina; Austin, TX; Santa Monica, CA; and Burlington, VT.

Systematically Reduce Downstream Channel Erosion: A few communities have sought to reduce downstream channel erosion by installing retrofits in urbanizing subwatersheds. This approach requires systematic installation of channel protection storage retrofits throughout the stream corridor. The strategy works best in impacted subwatersheds where the greater storage volume needed for channel protection can be more easily found. In recent years, this restoration objective has been linked to reduced nutrient loads derived from eroding streambanks. Two notable subwatersheds where channel protection has been a primary restoration objective include Watts Branch and Minebank Run in Maryland.

Support Stream Restoration: This objective uses upstream retrofits to provide hydrologic control to support downstream restoration projects. Individual retrofits are installed above specific stream reaches where stream restoration is planned. The retrofits may provide recharge, water quality and/or channel protection, depending on the specific design needs of the downstream project. The retrofits regulate the volume, duration, frequency, or peak discharge of stormflow, thereby creating a more stable

and predictable hydrologic regime for the new stream (see Manual 4). The long-term success of many stream repair restoration projects is contingent on effective upstream retrofits. Notable examples of paired retrofit/stream repair projects on individual streams include Accotink Creek, VA, and Watts Branch, Longwell Branch and Wheaton Branch (MD).

Comprehensive Watershed Restoration: The ideal objective is a comprehensive approach to restore subwatersheds that integrates retrofits in the context of other stream repair, riparian reforestation, discharge prevention, upland reforestation, pollution source control and improved municipal practices (Manual 1).

1.3 Rainfall, Runoff and Retrofits

Once core retrofit objectives are selected, they need to be translated into subwatershed sizing criteria. For this reason, the retrofit team must understand the relationship between rainfall, runoff and retrofits in their community. Retrofitting is fundamentally driven by the distribution of rainfall events. This section introduces the concept of the rainfall frequency spectrum, and how it can be used to define the target runoff volumes for retrofitting.

In the course of a year, many precipitation events occur within a community. Most events are quite small but a few can be several inches deep. A rainfall frequency spectrum describes the average frequency of the depth of rainfall events that occur during a normal year (adjusted for snowfall). Figure 1.1 provides an example of a typical rainfall frequency spectrum that shows the percent of rainfall events that are equal to or less than the indicated rainfall depth. As can be seen, the majority of storms are relatively

small but a sharp upward inflection point occurs at about one-inch of rainfall.

The rainfall frequency spectrum outlines five different zones that define targets for different stormwater treatment objectives, as follows:

Recharge: targets rainfall events that create little or no runoff but contribute much of the annual groundwater recharge at a site (denoted as **Rev**)

Water Quality: targets rainfall events that deliver the majority of the stormwater pollutants during the course of a year (denoted as **WQv**)

Channel Protection: targets storms that generate bankfull and sub-bankfull floods that cause stream channel enlargement (denoted as **Cpv**)

Overbank Floods: targets large and infrequent storm events that spill over to the floodplain and cause damage to infrastructure and streamside property (denoted as **Qp₁₀**).

Extreme Storms: controls the largest, most infrequent and most catastrophic floods that threaten structures and public safety (e.g., commonly known as the 100-year storm; denoted as **Qp₁₀₀**).

In general, retrofitting focuses on the lower end of the rainfall frequency spectrum (i.e., managing runoff for recharge, water quality and channel protection). Subwatershed retrofitting to control overbank floods or extreme storms is rarely attempted since it is hard to get enough retrofit storage to manage runoff at this end of the spectrum. As a result, flood mitigation projects are normally installed to prevent problems

within a specific flood-prone reach and not on a subwatershed-wide basis.

This manual primarily focuses on water quality treatment, although reference is often made to runoff reduction and channel protection. Table 1.2 illustrates the

geographic variability in the rainfall frequency spectrum across the nation. The retrofit team can use the table to develop localized retrofit sizing criteria or they can derive their own rainfall frequency spectrum using the guidance presented in Table 1.3.

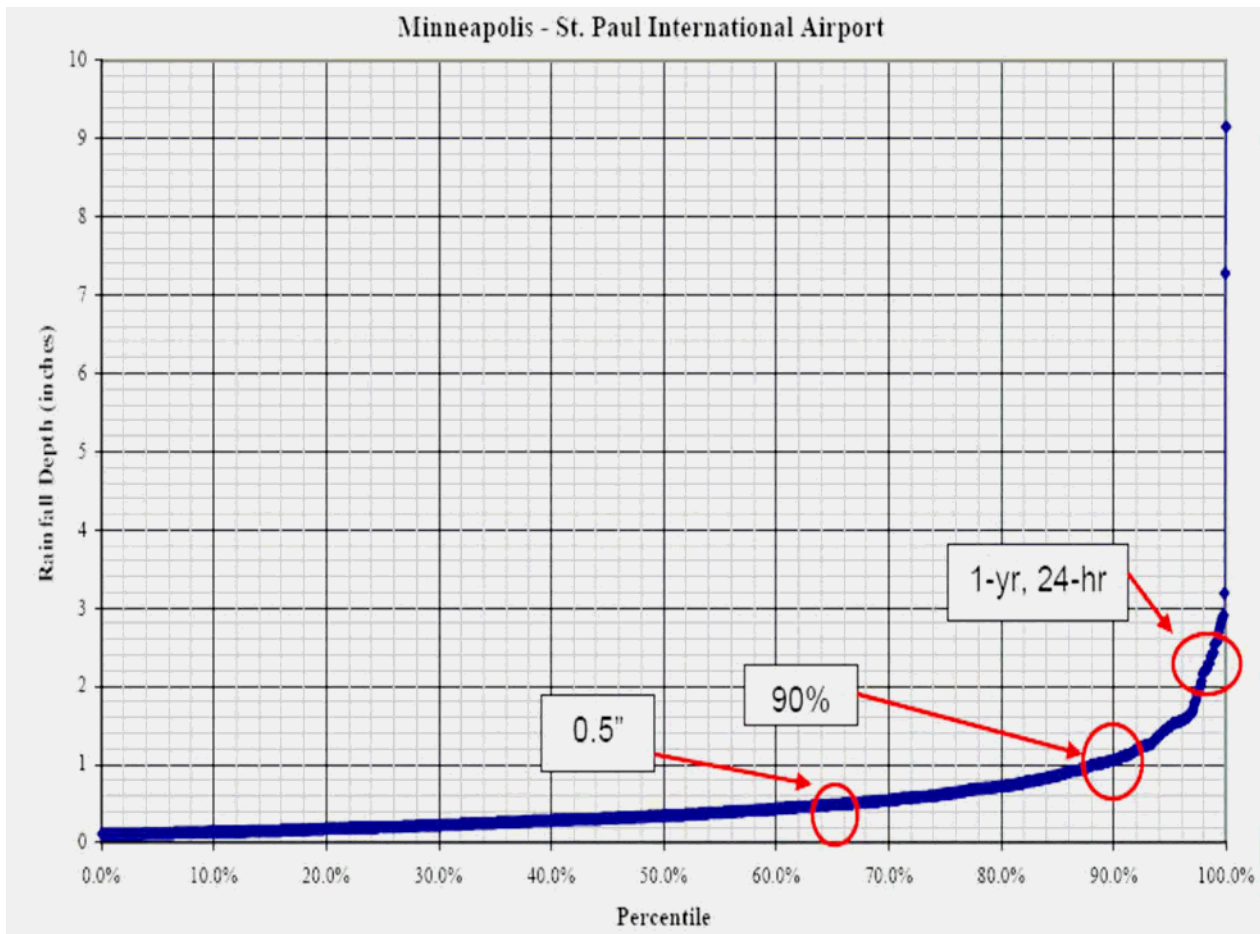

Figure 1.1: Rainfall Frequency Spectrum for Minneapolis-St. Paul Airport, 1971-2000

City	Precipitation		Rainfall event: Depth in inches ¹				
	Annual Inches	Days ²	50%	75%	90% ³	95%	99% ⁴
Atlanta, GA	50	77	0.5	0.9	1.6	2.1	3.4
Knoxville, TN	48	85	0.4	0.7	1.2	1.5	2.4
New York City, NY	44	74	0.4	0.7	1.2	1.7	2.7
Greensboro, NC	43	73	--	--	1.6	--	2.7
Boston, MA	43	76	0.4	0.6	1.2	1.6	2.6
Baltimore, MD	42	71	0.4	0.8	1.2	1.6	2.5
Buffalo, NY	41	88	0.3	0.5	0.8	1.1	1.8
Washington, DC	39	67	0.4	0.8	1.2	1.7	2.4
Columbus, OH	39	79	0.3	0.6	1.0	1.3	2.1
Kansas City, MO	38	63	0.4	0.7	1.1	1.7	3.2
Seattle, WA	37	90	--	--	1.3	1.6	1.7
Burlington, VT	36	79	0.3	0.5	0.8	1.1	1.7
Dallas, TX	35	32	--	--	1.1	--	3.2
Austin, TX	34	49	--	--	1.4	--	3.2
Minneapolis, MN	29	58	0.3	0.6	1.0	1.4	2.4
Coeur D'Alene, ID	26	88	0.2	0.3	0.5	0.7	1.1
Salt Lake City, UT	17	44	0.2	0.4	0.6	0.8	1.2
Denver, CO	16	37	--	--	0.7	--	--
Los Angeles, CA	13	22	--	--	1.3	--	--
Boise, ID	12	38	--	--	0.5	--	--
Phoenix, AZ	8	29	--	--	0.8	--	1.1
Las Vegas, NV	4	10	--	--	0.7	--	0.8

Notes: Dashed lines indicate no data available to compute.

1. Excludes rainfall depths of 0.1 inches or less
2. Average days per year with measurable precipitation
3. The 90% storm is frequently used to define the water quality volume
4. The 99% storm is equivalent to the one year storm and is used to define the channel protection volume.

<p>1. Obtain a long-term rainfall record from adjacent weather station (daily precipitation is fine, but try to obtain at least 30 years of daily record). NOAA has several websites with long-term rainfall records (See http://ols.nndc.noaa.gov)</p> <p>2. Edit out small rainfall events than are 0.1 inch or less (also edit out snowfall events that do not immediately melt)</p> <p>3. Using a spreadsheet or simple statistical package, analyze the rainfall time series and develop a frequency analysis to determine the percentage of rainfall events greater than or equal to a given numerical value (e.g., 0.2, 0.5, 1.0, 1.5 inches, etc).</p> <p>4. Construct a curve showing rainfall depth versus frequency, and create a table showing rainfall depths values for 50, 75 90, 95 and 95% frequencies.</p> <p>5. Use the data to define the recharge (20-50%), water quality event (90%) and one-year storm (99%).</p> <p>Notes: If a community is large or has considerable variation in elevation or aspect, the RFS analysis should be conducted at multiple stations. Other regional and national rainfall analysis such as TP-40 (NOAA) or USGS should always be used for rainfall depths or intensity greater than one-year in return frequency (e.g., 2, 5, 10, 25, 50 or 100 year design storm recurrence intervals)</p>

The rainfall frequency spectrum provides a strong basis to set targets for the desired water quality, runoff reduction or channel protection volume to seek in a subwatershed, as described below:

Setting Water Quality Volume Targets for Retrofitting: The water retrofit goal is to capture and treat the 90% storm, as defined by the local rainfall frequency spectrum. This criterion optimizes runoff capture resulting in high load reduction for many stormwater pollutants. The rainfall depth associated with the 90% storm varies geographically, but typically ranges between 0.8 and 1.2 inches for most parts of the country (see Table 1.2). Once the water quality storm has been selected, it is relatively easy to define the retrofit storage volume needed at both the site and subwatershed scale using the data provided in Table 1.4.

Several practical implications arise when setting the water quality target volume for a

subwatershed - particularly when it comes to finding enough retrofit sites to meet it. In general, when the target volume is large, fewer retrofit sites can be found that have adequate space to capture and treat it. An optimization point exists between the target volume and expected number of retrofit locations, as shown in Figure 1.2.

One curve shows how the fraction of subwatershed treatment increases when the capture volume becomes progressively greater. The second curve shows how the number of feasible retrofit sites declines as a function of a higher capture volume. An optimization point exists in most subwatersheds where the two curves intersect. The retrofit optimization point also reflects the degree of subwatershed impervious cover- shifting towards 0.25 inches in highly developed subwatersheds and as much as 1.25 inches in lightly developed ones. This optimization point is an important factor to define early in the retrofit scoping process.

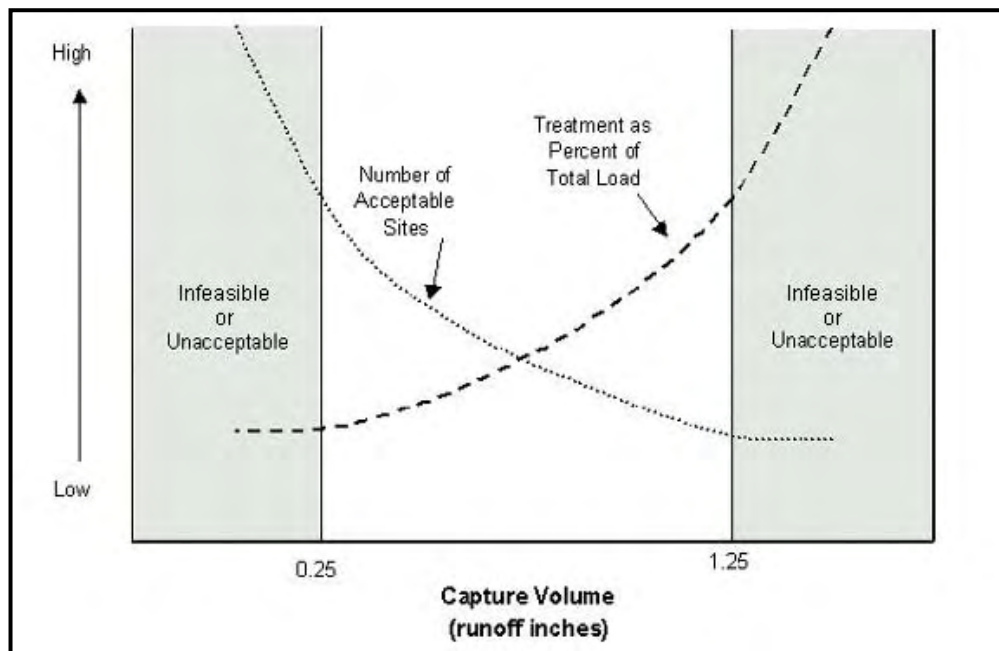

Figure 1.2: Optimization point for retrofit treatment.

Table 1.4: An Estimate of WQv for Select US Cities (in order of descending annual rainfall)

City	90% Rainfall Event (in.)	Subwatershed Imperviousness (%)			
		10%	30%	60%	90%
		WQv (cubic feet/acre) ¹			
Atlanta, GA	1.6	813	1,859	3,427	4,995
Greensboro, NC	1.6	813	1,859	3,427	4,995
Austin, TX	1.4	711	1,626	2,998	4,371
Seattle, WA	1.3	661	1,510	2,784	4,058
Los Angeles, CA	1.3	661	1,510	2,784	4,058
Knoxville, TN	1.2	610	1,394	2,570	3,746
New York City, NY	1.2	610	1,394	2,570	3,746
Boston, MA	1.2	610	1,394	2,570	3,746
Baltimore, MD	1.2	610	1,394	2,570	3,746
Washington, DC	1.2	610	1,394	2,570	3,746
Kansas City, MO	1.1	559	1,278	2,356	3,434
Dallas, TX	1.1	559	1,278	2,356	3,434
Columbus, OH	1.0	508	1,162	2,142	3,122
Minneapolis, MN	1.0	508	1,162	2,142	3,122
Buffalo, NY	0.8	407	929	1,713	2,497
Burlington, VT	0.8	407	929	1,713	2,497
Phoenix, AZ	0.8	407	929	1,713	2,497
Denver, CO	0.7	356	813	1,499	2,185
Las Vegas, NV	0.7	356	813	1,499	2,185
Salt Lake City, UT	0.6	305	697	1,285	1,873
Coeur D'Alene, ID	0.5	254	581	1,071	1,561
Boise, ID	0.5	254	581	1,071	1,561

¹ The WQv values provided above were estimated based on the methodology presented in Table 1.3 and the depth of rainfall associated with the 90% events shown in Table 1.2.

Setting Runoff Reduction Volume

Targets: The target storage volume for runoff reduction ranges from 20 to 50% of the target WQv and can be attained through canopy interception, rooftop disconnection, infiltration, rainwater harvesting, evaporation or long-term storage. The specific target volume for runoff reduction is defined based on local subwatershed characteristics, and the desired degree of CSO relief, groundwater recharge or baseflow maintenance. Runoff reduction volumes are deceptively low in comparison to other target volumes. Designers should be aware that most storage retrofits do not reduce much runoff volume, so that dozens or even hundreds of small on-site

retrofits may be needed to achieve runoff reduction objectives.

Setting Channel Protection Volume

Targets: The recommended channel protection criterion is 24 hours of extended detention for the runoff generated by the 1-year 24-hour design storm. This is generally equivalent to the rainfall depth for the 99% storm depicted in Table 1.2. Runoff is stored and gradually released over a 24-hour period so that critical erosive velocities in downstream channels are not exceeded during the entire storm hydrograph. As a very rough rule, the storage capacity needed to provide channel protection is about 60% of the one-year storm runoff volume. Designers will normally need to

define actual channel protection volumes using hydrologic and hydraulic models that simulate specific channel conditions and subwatershed characteristics (See Appendix C for further guidance).

Channel protection storage generally exceeds the water quality storage volume by 20 to 40% in most regions of the country (Figure 1.3). There are some interesting exceptions where Cpv storage is actually less than the WQv storage – most notably in arid and semi-arid regions and the Pacific Northwest where rainfall events are frequent but not particularly intense. It may seem counterintuitive that the Cpv could ever be higher than the WQv, since the rainfall depth associated with the 99% storm must always be greater than the 90% storm. The key difference is in the different way the *treatment volume* is

defined for each kind of storage. The WQv is defined as 100% of the runoff volume produced by the 90% rain depth; whereas the Cpv is estimated as 60% of the runoff volume produced for the 99% rain depth.

Both WQv and Cpv storage may be needed to attain certain subwatershed objectives, which effectively doubles the total storage volume needed. The best conditions to find enough channel protection storage are in sensitive or impacted subwatersheds that have a high existing pond density and/or abundant public land in stream corridors. In many cases, channel protection treatment is not possible for the subwatershed as a whole, but may be feasible for individual stream reaches where stream repairs are being proposed.

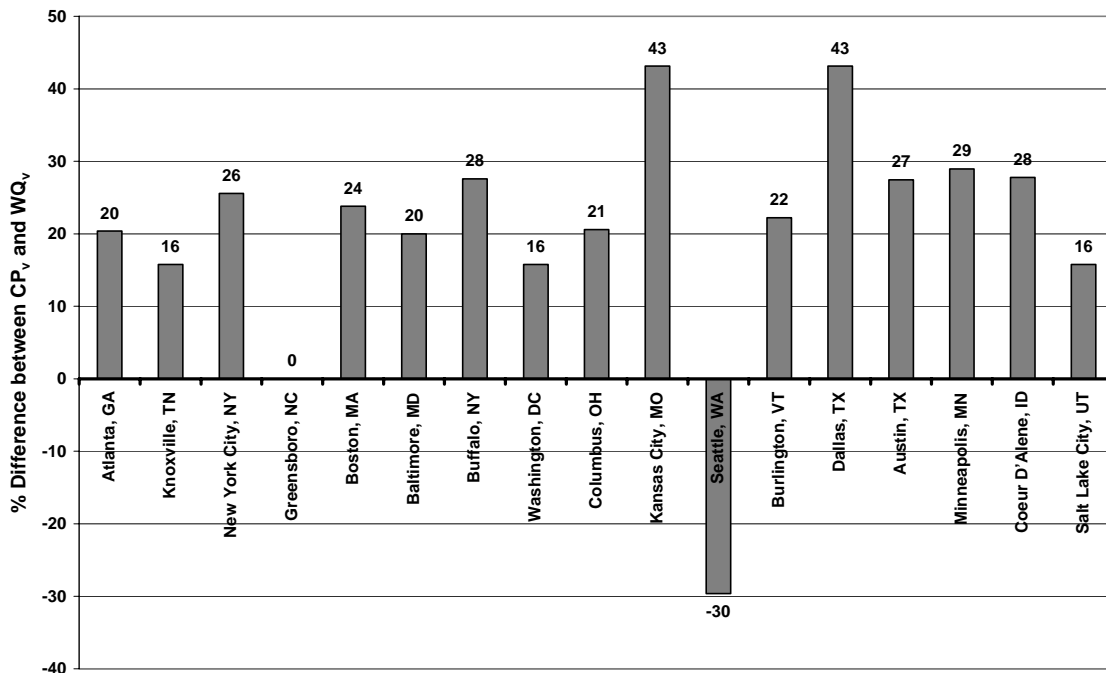

Figure 1.3: Difference in CPv storage and WQv storage for select U.S. cities.

1.4 The Search for Subwatershed Storage

Subwatershed treatment is an important concept when assessing retrofit potential. Designers need to calculate the total water quality treatment volume needed to meet the restoration objectives. The feasibility of capturing and treating this volume will be different in every subwatershed.

Conceptually, subwatershed treatment is represented by the following equation:

$$\text{Total volume} = \text{Storage retrofits} + \text{on-site retrofit storage} + \text{future redevelopment treatment}$$

The redevelopment term reflects future opportunities to provide stormwater treatment within the subwatershed as land is redeveloped. While redevelopment is not an explicit component of the retrofitting process, it is important to update existing stormwater criteria to take advantage of these long-term opportunities to install new treatment.

The challenge of retrofitting is to find enough storage to make a real difference in a subwatershed. The estimated storage needed for a 5,000 acre subwatershed as a fraction of impervious cover can be seen in Figure 1.4. The required storage volume can consume a significant percentage of subwatershed area, particularly when channel protection and flood control storms are being managed.

Retrofitting becomes more and more difficult and costly to pursue as subwatershed imperviousness increases. At lower levels of impervious cover, it is generally possible to find needed storage volumes for water quality and, sometimes, channel protection. Available land to provide water quality and/or channel protection is harder to come by at higher levels of subwatershed impervious cover (45-60%).

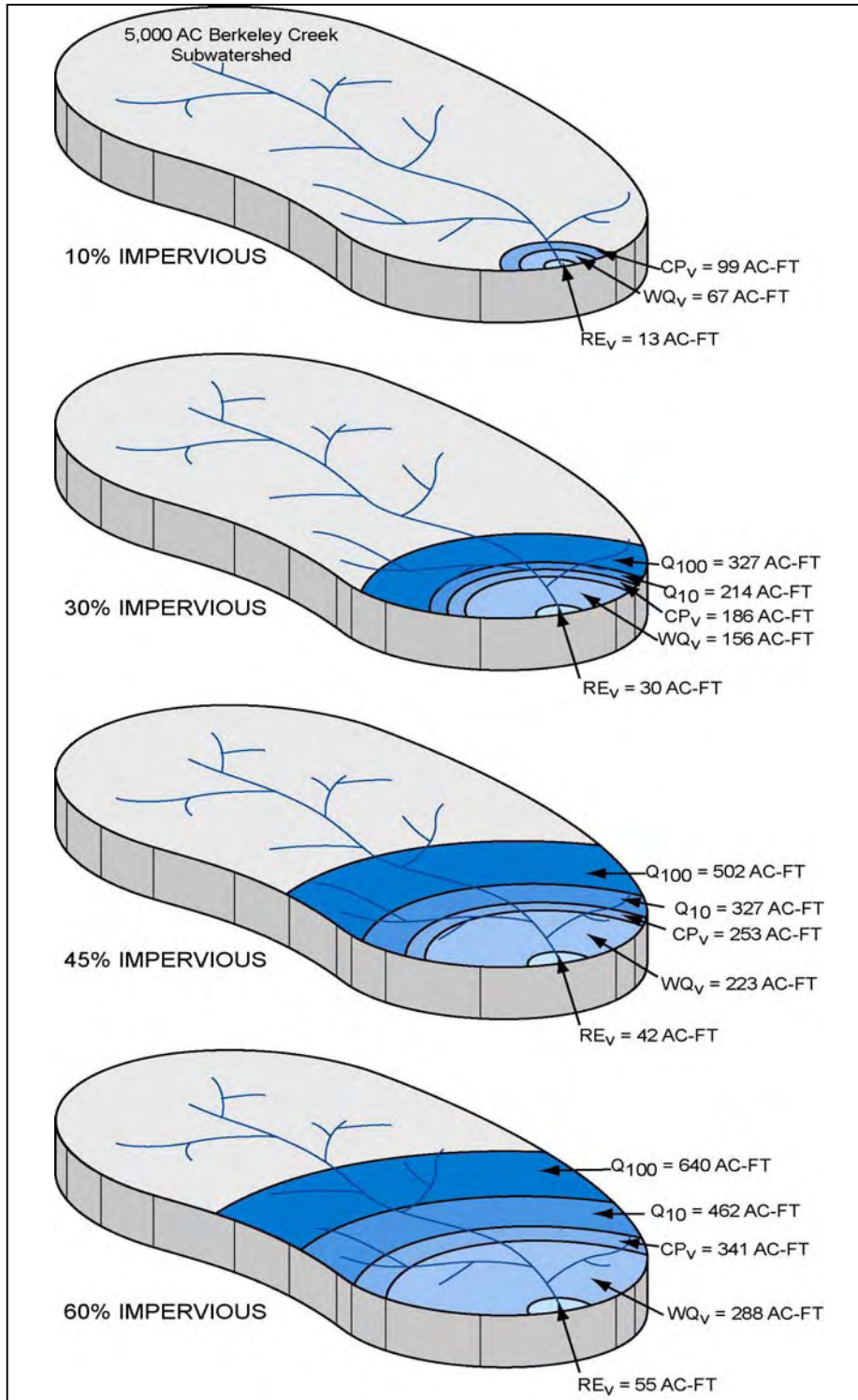

Figure 1.4: The Range of Retrofit Opportunities and Goals as a Function of Impervious Cover
 (Note: Areas shown reflect one-foot depth of treatment)

1.5 The Range of Retrofit Practices

Retrofits can be classified by the amount of subwatershed area they treat. *Storage retrofits* treat drainage areas ranging from five to 500 acres. By contrast, *on-site* residential retrofits may individually treat as little as 500 square feet of contributing drainage area. On-site, non-residential retrofits normally treat less than five acres of contributing drainage area, and frequently less than one.

Storage and on-site retrofits represent two different approaches to attain treatment storage and involve different design and assessment methods (Table 1.5). As a general rule, storage retrofits are the most cost-effective approach to meet most subwatershed restoration objectives, although both retrofit approaches may be needed to get the desired level of subwatershed treatment.

Storage Retrofit Classification: Storage retrofits are classified using common locations in a subwatershed where large

storage volumes can be found (Figure 1.5). The six major storage retrofit locations are described in detail in Table 1.6. Most storage retrofits are located on publicly owned or controlled land, and rely on some combination of extended detention, wet pond, constructed wetland or bioretention for stormwater treatment.

On-Site Retrofit Classification: On-site retrofits are classified based on the type or location of impervious area they treat, such as individual rooftops, small parking lots, streets, stormwater hotspots and other small impervious areas (Figure 1.6). The seven on-site retrofit locations are described in Table 1.7. On-site retrofits treat the quality and/or reduce the volume of runoff generated by small urban source areas and rely on bioretention, filtering, infiltration, swales or rooftop treatment. On-site retrofits are an effective strategy in ultra-urban subwatersheds that lack space for storage retrofits, and can also provide excellent opportunities to improve public awareness and involvement. Most on-site retrofits are normally installed on private land but involve some form of public delivery.

Storage Retrofits	On-site Retrofits
Serve 5 to 500 acres	Serve 0.1 to 5 acres
Generally constructed on public land	Generally constructed on private land
May need dozens in a subwatershed	May need hundreds in subwatershed
Assessed at subwatershed scale	Assessed at catchment/neighborhood scale
Moderate cost per impervious acre treated	High cost per impervious acre treated
Impractical in ultra urban areas	Practical in ultra urban areas
Permitting can be extensive	Few permits are needed
Can provide all stormwater targets	Only provide recharge and water quality
Public construction	Public delivery
Utilize ED, wet pond, and wetlands	Rely on bioretention, filtering, infiltration, swales and other treatment practices

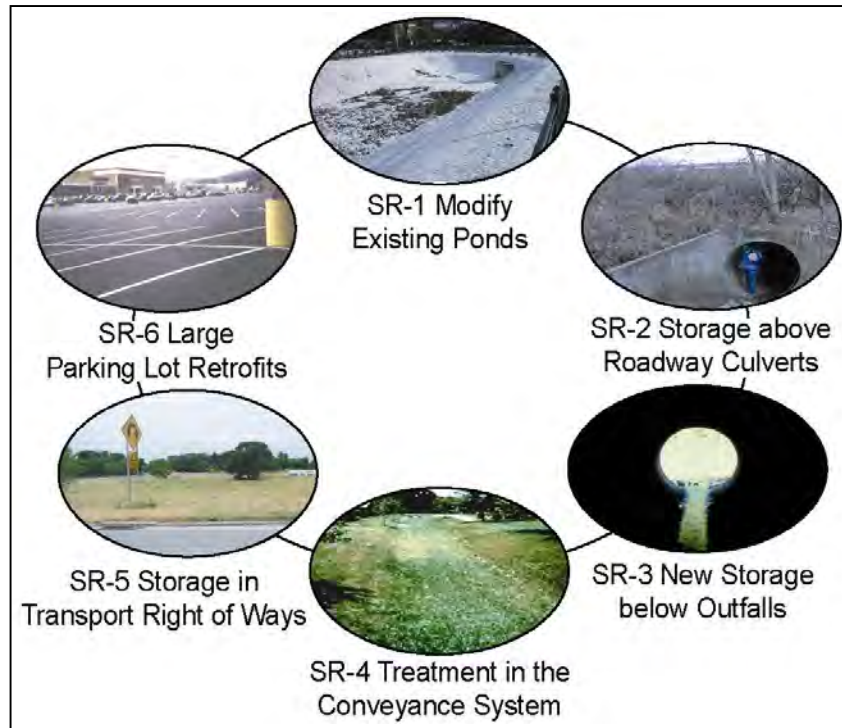

Figure 1.5: Six different storage retrofit options can be used.

Table 1.6: The Six Most Common Storage Retrofit Locations in a Subwatershed	
Where to Look	How to Get Storage
SR-1 Add Storage to Existing Ponds	Add water quality treatment storage to an existing pond that lacks it by excavating new storage on the pond bottom, raising the height of the embankment, modifying riser elevations/dimensions, converting unneeded quantity control storage into water quality treatment storage and/or installing internal design features to improve performance
SR-2 Storage Above Roadway Culverts	Provide water quality storage immediately upstream of an existing road culvert that crosses a low gradient, non-perennial stream without wetlands. Free storage is created by adding wetland and/or extended detention treatment behind a new embankment just upstream of the existing roadway embankment
SR-3 New Storage Below Outfalls	Flows are split from an existing storm drain or ditch and are diverted to a stormwater treatment area on public land in the stream corridor. Works best for storm drain outfalls in the 12- to 36- inch diameter range that are located near large open spaces, such as parks, golf courses and floodplains.
SR-4 Storage in Conveyance System	Investigate the upper portions of the existing stormwater conveyance system to look for opportunities to improve the performance of existing swales, ditches and non-perennial streams. This can be done either by creating in-line storage cells that filter runoff through swales and wetlands or by splitting flows to off-line treatment areas in the stream corridor
SR-5 Storage in Road Right of Ways	Direct runoff to a depression or excavated stormwater treatment area within the right of way of a road, highway, transport or power line corridor. Prominent examples include highway cloverleaf, median and wide right of way areas.
SR-6 Storage Near Large Parking Lots	Provide stormwater treatment in open spaces near the downgradient outfall of large parking lots (5 acres plus).

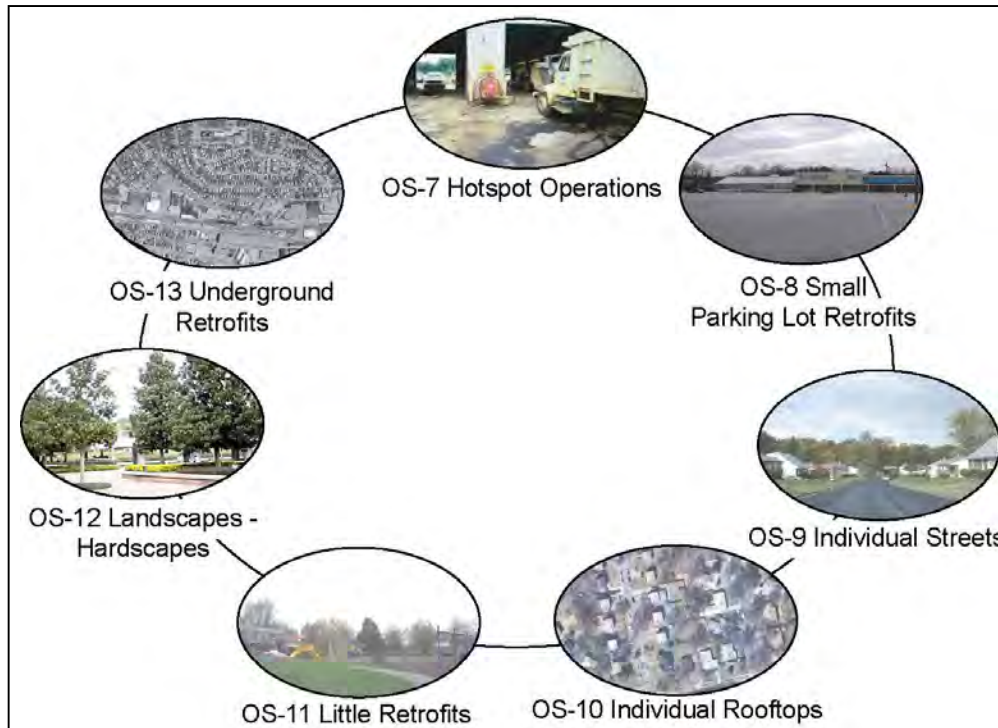

Figure 1.6: These seven retrofit options are available for on-site treatment.

Table 1.7: The Seven Most Common On-Site Retrofit Locations in a Subwatershed	
Where	How
OS-7 Hotspot Operations	Install filtering or bioretention treatment to remove pollutants from confirmed or severe stormwater hotspots discovered during field investigation
OS-8 Small Parking Lots	Insert stormwater treatment within or on the margins of small parking lots (less than five acres). In many cases, the parking lot is delineated into a series of smaller on-site treatment units.
OS-9 Individual Streets	Look for opportunities with the street, its right of way, cul-de-sacs and traffic calming devices to treat stormwater runoff before it gets into the street storm drain network
OS-10 Individual Rooftops	Disconnect, store and treat stormwater runoff generated from residential and commercial rooftops close to the source.
OS-11 Little Retrofits	Convert or disconnect isolated areas of impervious cover and treat runoff in an adjacent pervious area using low tech approaches such as a filter strip
OS-12 Landscapes Hardscapes	Reconfigure the plumbing of high visibility urban landscapes, plazas and public spaces to treat stormwater runoff with landscaping and other urban design features.
OS-13 Underground	Provide stormwater treatment in an underground location when no surface land is available for surface treatment. Use this as a last resort at dense ultra-urban sites.

1.6 Stormwater Treatment Options for Retrofitting

Eight different stormwater treatment options can be used for retrofitting (Figure 1.7). Each treatment option differs greatly in its pollutant removal capability, hydrologic benefit and retrofit suitability. More detailed information about each stormwater treatment option can be found in Chapter 3 and Appendix I. Some of the basic differences are compared in Table 1.8.

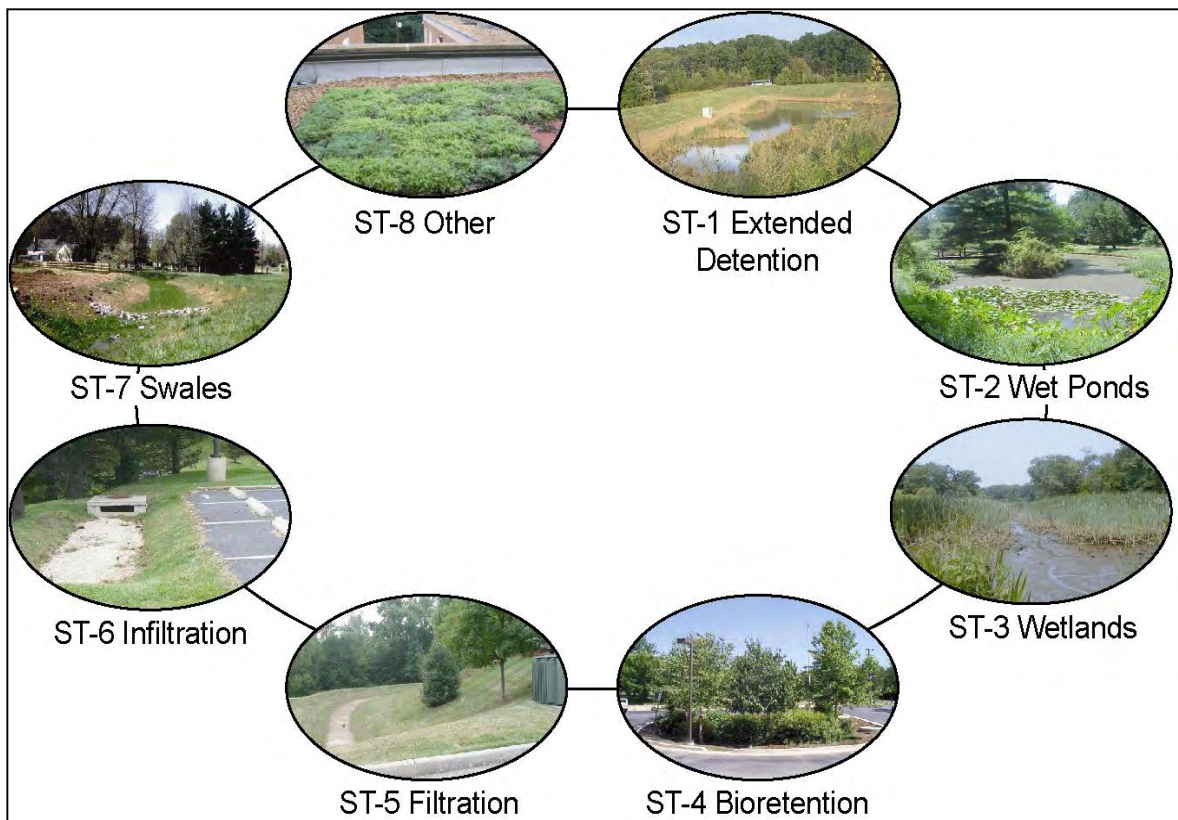

Figure 1.7: Eight stormwater treatment options are available for retrofitting.

Table 1.8: Stormwater Treatment Options for Retrofitting	
Stormwater Treatment Option	How it Works
ST-1 Extended Detention	This option relies on 12 to 24 hour detention of stormwater runoff after each rain event within a pond, with portions of the pond drying out in between storm events. Extended detention (ED) allows pollutants to settle out, and if enough storage is available, can also provide downstream channel protection.
ST-2 Wet Ponds	Wet ponds consist of a permanent pool of standing water. Runoff from each new storm enters the pond and partially displaces pool water from previous storms. The pool also acts as a barrier to re-suspension of sediments and other pollutants removed during prior storms.
ST-3 Constructed Wetlands	Constructed wetlands are shallow depressions that receive stormwater for treatment. Runoff from each new storm displaces runoff from previous storms, and the residence time of several days to weeks allows multiple pollutant removal processes to operate.
ST-4 Bioretention	Bioretention is an innovative urban stormwater practice that uses native forest ecosystems and landscape processes to enhance stormwater quality. Bioretention areas capture sheet flow from impervious areas and treat the stormwater using a combination of microbial soil processes, infiltration, evapotranspiration, and plants.
ST-5 Filtering Practices	Filter practices function by filtering runoff through an engineered media and collecting treated runoff in an underdrain. The media may consist of sand, soil, compost, or a combination of these.
ST-6 Infiltration Practices	An infiltration trench is a rock-filled chamber with no outlet that receives stormwater runoff. Stormwater runoff passes through some combination of pretreatment measures, such as a swale or sediment basin, before entering the trench where it infiltrates into the soil.
ST-7 Swales	Swales are a series of engineered, vegetated, open channel practices that are designed to treat and attenuate stormwater runoff for a specified water quality volume.
ST-8 Other Retrofit Treatment	These on-site practices provide treatment of roof runoff using rain gardens, rain barrels, green roofs, cisterns, stormwater planters, dry wells, or permeable pavers.

1.7 Basic Steps in Stormwater Retrofitting

An eight step process is recommended to systematically search for retrofit storage in a subwatershed (Figure 1.8). The process begins with retrofit scoping and concludes with maintenance of the constructed retrofit. Chapter 4 provides more information on each step of the retrofit process.

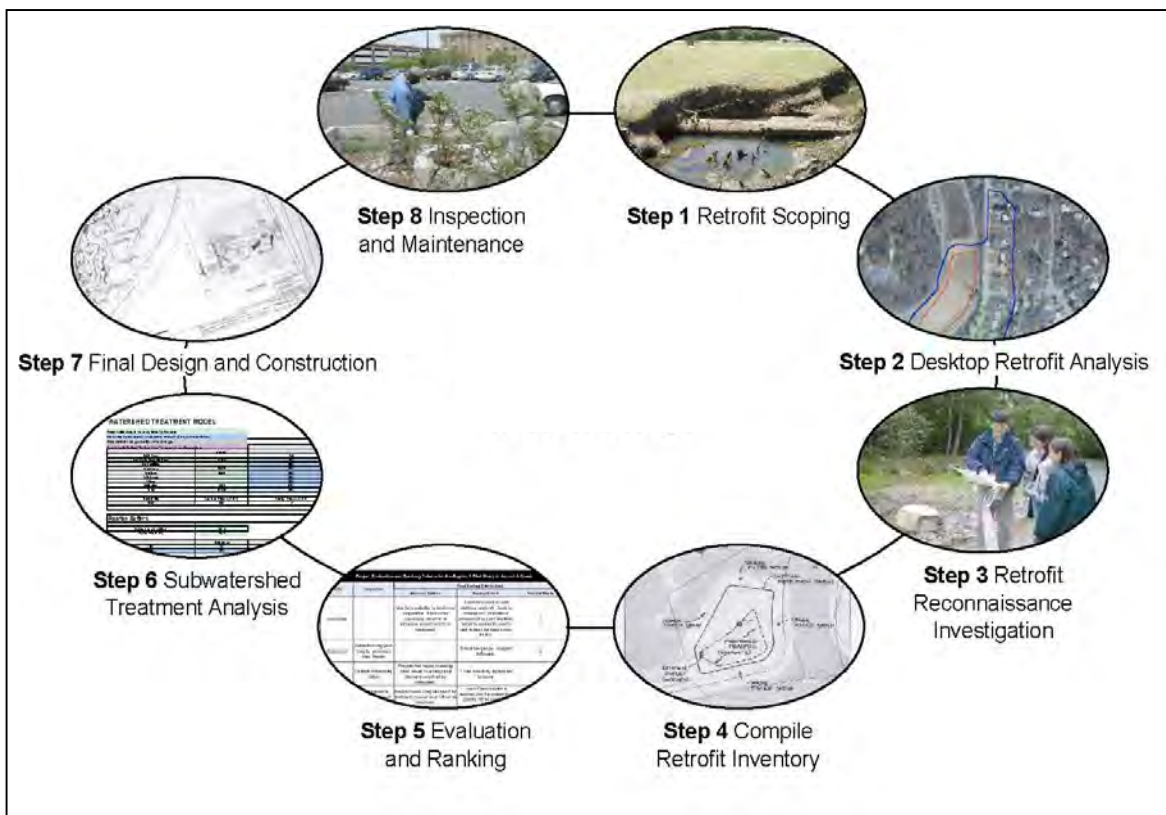

Figure 1.8: The eight basic steps of the stormwater retrofitting process.

1.8 Retrofit Economics

The first generation of retrofits primarily focused on demonstrating that retrofits could achieve restoration objectives, with little attention devoted to finding the least costly restoration solution. The next generation of retrofits, however, will need to demonstrate that they represent the most cost effective solution to the restoration problem they are designed to address. Appendix E contains an analysis of construction cost data from nearly 100 retrofit projects installed around the country. Some key findings on retrofit economics from the 2006 cost survey are shared below.

Retrofitting can be a costly enterprise. The cost to construct retrofits is 1.5 to 4 times greater than the cost to construct stormwater practices at new development sites. The extra costs for retrofits are related to site constraints, higher excavation costs, greater

design complexity, more construction contingencies, additional engineering studies, enhanced landscaping and the experimental nature of many designs. Given that many retrofits are prototypes, it is expected that unit costs may decline in the future as contractors gain more familiarity with them.

There may be rare instances when retrofit costs can be based on new practice cost equations, but only when: land is abundant to provide maximum flexibility in site layout, site topography is such that a neutral earth balance can be attained and no major investments are contemplated for special plumbing, environmental permits, utility relocation or major landscaping. Appendix I presents new practice cost equations for retrofit sites that meet these rare conditions.

Figure 1.9 compares the median and quartile range in base construction cost for 18

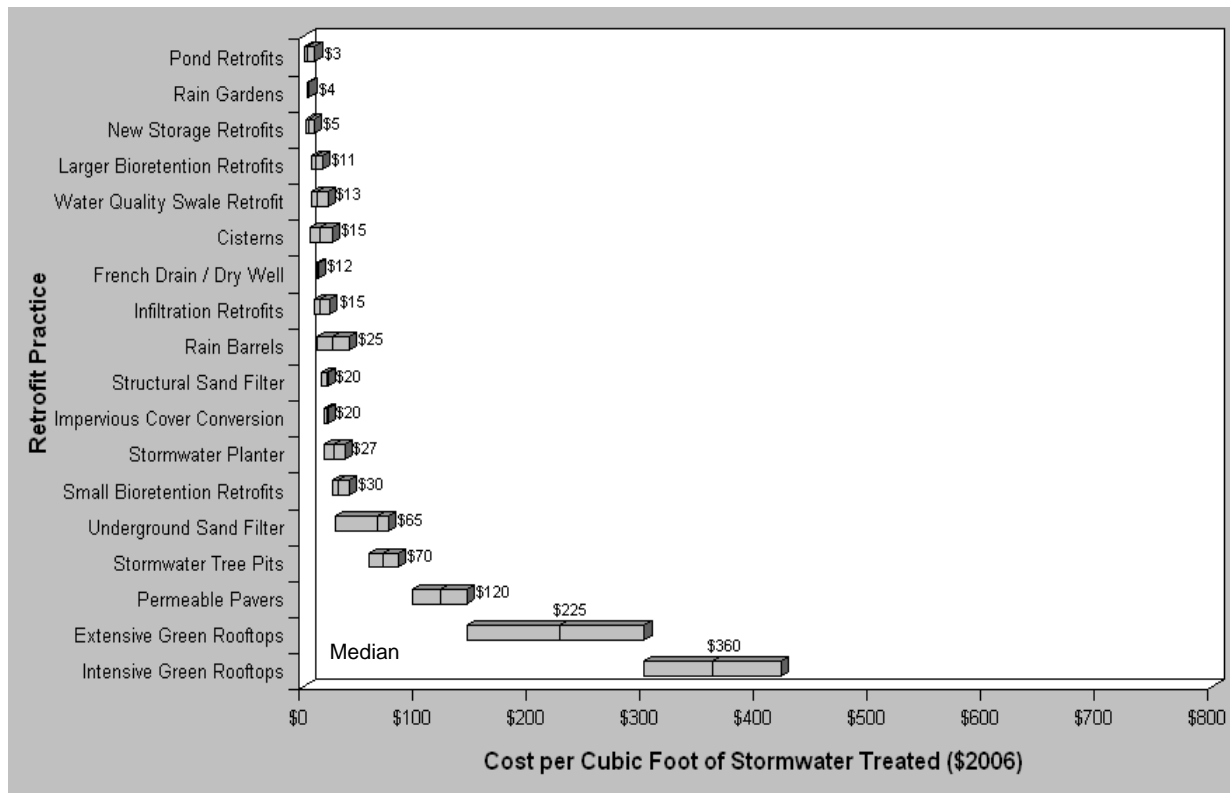

Figure 1.9: Range of base construction costs for various retrofit options.
 (Note: Boxes show 25% and 75% quartiles; the line represents the median)

different retrofit techniques. As can be seen, pond retrofits, rain gardens and new storage retrofits are the least expensive to construct, whereas ultra-urban techniques such as underground filters, tree pits, permeable pavers and green rooftops are the most expensive. The design team should carefully review these unit costs during initial scoping to ensure they are targeting the most cost-effective retrofits in a subwatershed.

Storage retrofits are generally more cost-effective than on-site retrofits, primarily due to economies of scale related to the large drainage areas they treat. In general, retrofits serving the smallest drainage areas tend to have the greatest unit cost. This finding suggests that designers should try to exhaust all possibilities for storage retrofits in a subwatershed before they embark on an on-site retrofit approach.

Construction costs for the same retrofit technique can vary by two orders of magnitude. For example, the unit construction cost for the least and most expensive pond retrofits ranged from \$1,350 to \$107,000 per impervious acre treated. An even wider range was reported for bioretention retrofits (\$2,000 to \$327,000 per impervious acre). Designers should always look for key factors that can drive up the cost of retrofitting when they evaluate individual retrofit sites. A refined approach to calculate accurate cost estimates for individual retrofit projects is described in Appendix E.

The design and engineering (D&E) costs for both on-site and storage retrofits ranges from 32 to 40% of base construction cost (higher end when environmental permits

must be secured). Total D&E costs for retrofits are higher than new stormwater practices, given their higher base construction costs. Land acquisition costs for all storage retrofits are assumed to be zero since they are generally constructed on public land. However, land acquisition costs must be added if land rights or easement need to be secured to build a project. On-site retrofits also have a hidden cost to persuade owners to install them on private land. The program cost to promote and deliver on-site retrofits may rival actual construction costs. Lastly, the retrofit costs shown here do not include the cost to find, assess and rank retrofits at the subwatershed level (see Chapter 4 for unit costs and scoping guidance).

The most important number is the aggregate cost to construct retrofits across an entire subwatershed. Returning to the 5,000 acre subwatershed example, assume that 70% retrofit coverage is desired. If it is further assumed that storage retrofits are used to obtain 80% of the subwatershed treatment and on-sites for the remainder, it is possible to get a sense of the number and cost of retrofits needed for the subwatershed (Table 1.9). At 10% subwatershed impervious cover, the retrofit bill is nearly \$7 million and climbs to \$20 to 40 million at higher levels of subwatershed impervious cover. While most communities spread out this investment over 5 or 10 years, it clearly underscores the need to devise creative retrofit delivery strategies to get the job done.

Subwatershed Impervious Cover	Impervious Acres Treated	Number of retrofits required	Base Construction Costs	Total Restoration Cost
10%	353	OS = 141 SR = 6	\$1,582,500 \$3,579,000	\$6,700,000
30%	1,088	OS = 435 SR = 17	\$4,892,500 \$10,965,000	\$20,600,000
45%	1,650	OS = 660 SR = 26	\$7,425,000 \$16,740,000	\$31,400,500
60%	2,194	OS = 878 SR = 35	\$9,900,000 \$22,000,000	\$41,500,000
Assumptions:				
<ul style="list-style-type: none"> • 50 acres treated per storage retrofits and 0.5 acre treated per on-site retrofit • 70% of the entire subwatershed area to be retrofit • 80% of the watershed is treated by storage retrofits; 20% is treated with on-site retrofits • Storage retrofits are equally split between pond retrofits and new facilities • 25% of on-sites are on residential land and 75% are non-residential sites. • Cost per impervious acre treated are: \$9,500 for pond retrofits; \$15,500 for new storage facilities; \$15,000 for residential on-sites; \$25,000 for non-residential on-site retrofits • Total cost includes D&E at 32% of base construction cost 				

1.9 Strategies to Deliver Retrofit Projects at the Subwatershed Level

Subwatershed retrofitting is a major long-term commitment where dozens or even hundreds of individual retrofit projects are built over a multi-year timeframe. As previously noted, retrofitting can be quite costly and is normally the single largest expense involved in watershed restoration. Given the large number of retrofit projects, their high cost and the long timeframe over which they are built, it is important to discuss the strategies on how retrofits can be delivered in a widespread manner.

This section describes a multi-pronged strategy to sustain public investment in retrofitting over many years. The strategy involves multiple ways to deliver retrofits on

both public and private land (Figure 1.10). Many stormwater managers mistakenly believe that retrofitting primarily involves capital construction projects built on public land. Much greater subwatershed coverage, however, can be achieved by a creative combination of financing, education, subsidies, permit coordination and stormwater regulations. To some extent, the retrofit delivery methods are sequential in nature -- the first methods are easier to implement early; whereas, latter methods provide expanded treatment in the future.

Demonstration Retrofits are the usually the first retrofit delivery method. The best sites are located on public land that is highly visible or receives heavy foot traffic, such as community parks, greenway trails, local schools or the city hall. Severe municipal hotspots, such as public works yards, may also be good candidate sites. Demonstration

retrofits are normally financed by state or federal water quality grants. Demonstration retrofits can be installed at any stage of the retrofit process, particularly when they can test a new or innovative retrofit technique.

Although demonstration retrofits serve only a small fraction of subwatershed area, they are an excellent early action project for several reasons. First, retrofits can educate residents about urban stream impacts and restoration potential through interpretive signs, tree planting and other stewardship measures. Second, demonstration retrofits show restoration partners and stakeholders what the retrofit “product” looks like, which helps to increase community acceptance for future projects. Third, demonstration projects enable local agency staff to gain valuable retrofit design and construction experience that can be used to deliver other retrofits later.

Retrofits on Public Land: The next retrofit delivery method involves construction of storage retrofit projects on public land in the subwatershed. These retrofits are typically located in stream valleys, parks, public right of way and publicly-owned stormwater infrastructure. Public land retrofits are easier to deliver because they do not require land acquisition and can provide community benefits. Storage retrofits are preferred because they can cost-effectively treat the greatest fraction of subwatershed area. Experience has shown that it is possible to treat as much as 30 to 50% of a subwatershed through public land retrofits, particularly if the community owns land in the stream corridor.

Most public retrofits are financed by long-term capital construction budgets dedicated to retrofits or waterway improvements. Consequently, it may take a decade to construct all of the feasible public land

retrofits. This phase of retrofit delivery also requires an agency commitment to efficiently manage construction of multiple retrofit projects over time. Another good retrofit strategy is to integrate retrofits into ongoing municipal stormwater maintenance programs, particularly if the facilities are located on public land. The capital budget for stormwater maintenance can be modified to allocate funds to retrofit older ponds to improve their performance at the same time major maintenance problems are being corrected.

Encourage On-site Retrofits in Neighborhoods: This phase of retrofit delivery educates homeowners to persuade them to install low cost on-site retrofits on their property, such as rooftop disconnections, rain barrels or rain gardens. The most effective campaigns educate the public about need to restore watersheds, provide some simple construction tips, and direct interested residents where they can get more specific information and technical assistance. Local governments may wish to hire local watershed groups to “retail” technical assistance directly to neighborhoods and community associations. While it is doubtful that more than 5% of subwatershed residents will install on-site retrofits through education alone (Manual 8), the relatively low cost of the education program and its outreach and awareness benefits make it a good delivery investment at the outset of the retrofitting process.

Bundle Retrofits into Municipal Construction Projects: The next method incorporates retrofit delivery into other municipal construction capital projects. Communities are constantly investing in streetscaping, transportation projects, school construction, park improvements, water and

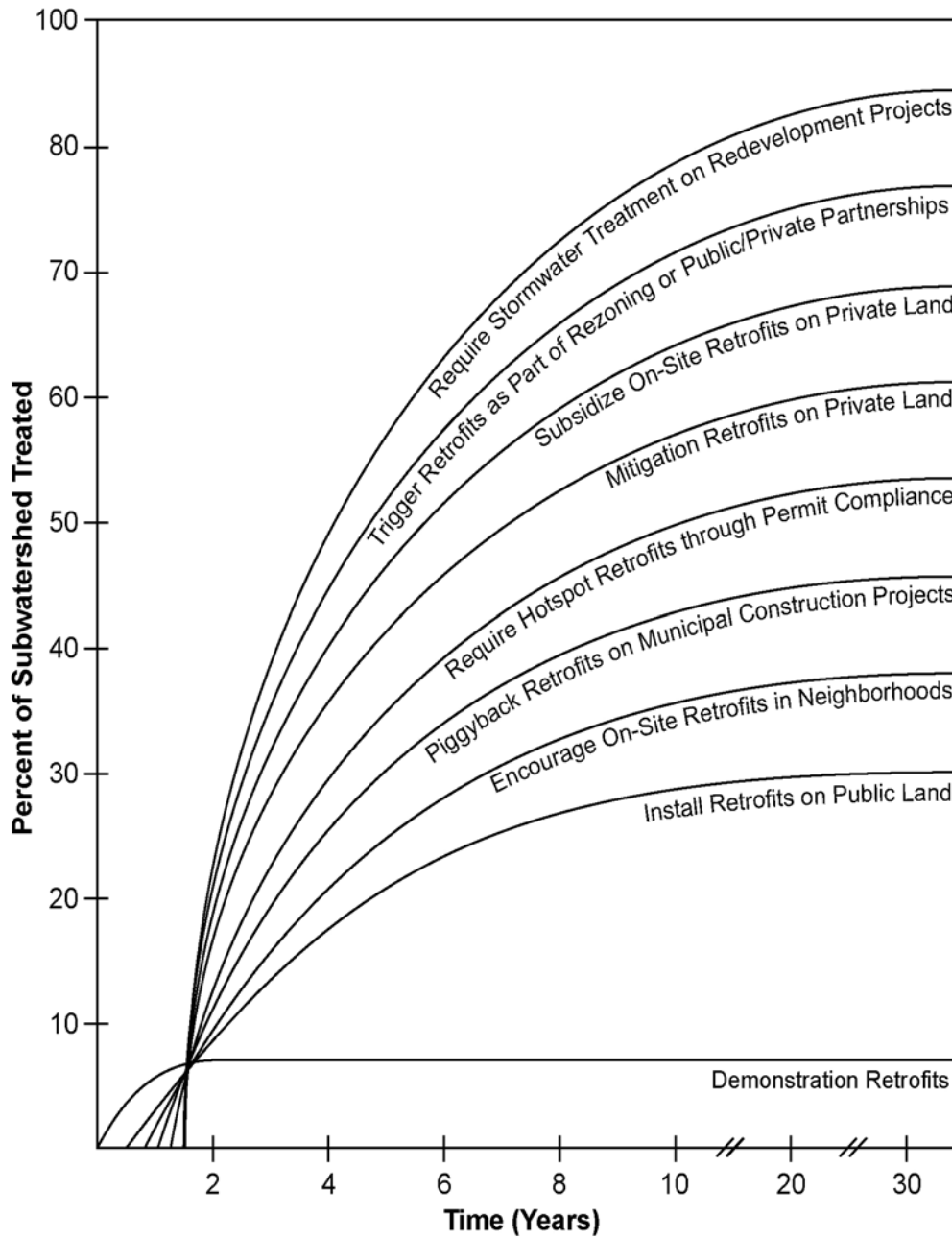

Figure 1.10. Ways to maximize retrofit delivery throughout the watershed

sewer line rehabilitation, drainage improvements and neighborhood revitalization. The strategy is to bundle retrofits into routine capital projects. In some cases, the match is relatively easy, e.g., including a storage retrofit as part of a culvert upgrade or installing water quality features into drainage improvements. Other bundled retrofits require much greater

interagency education and coordination efforts since many agencies do not consider watershed restoration as part of their primary mission. The bundling strategy is definitely worth the effort since capital budgets for other municipal construction categories exceed water resource spending by a factor of 100 to 500 (U.S. Census, 2006). The largest municipal construction

categories include schools, roads, water supply and wastewater treatment, parks and recreation and municipal building.

While some agencies may initially resist efforts to incorporate retrofits into their capital budgets, several recent trends may make it more appealing. First, many units of local government are now subject to municipal stormwater permits and are no longer exempt from treating the quality of the stormwater produced by their construction projects. Bundling retrofits into existing construction projects makes stormwater compliance easier. Second, municipal project managers are often subject to the same environmental permitting requirements as the private sector, and may find that constructing retrofits conveniently meets their off-site mitigation needs. Third, many communities have formally adopted policies to promote sustainable development and/or low impact design practices in their own municipal construction projects. Several progressive communities, such as Santa Monica, CA and Austin TX, have specified a minimum set-aside for construction of on-site stormwater retrofits in their municipal contracting process (CWP, 2006).

Require Hotspot Retrofits Through Permit Compliance: Stormwater hotspots deserve special attention when it comes to retrofit delivery, given their severe water quality impacts and unique regulatory status. The goal is to construct on-site retrofits to treat the quality of runoff from all severe stormwater hotspots in a subwatershed, using existing authority under industrial and/or municipal stormwater permits (see Retrofit Profile Sheet OS-7). The basic argument is that hotspot runoff violates water quality standards and warrants immediate treatment.

Hotspot retrofits are identified based on two systematic levels of subwatershed field inspection -- a Hotspot Site Investigation to identify severe hotspots (HSI- Manual 11) and a more intensive Hotspot Compliance Inspection to determine whether a structural retrofit is needed to treat hotspot runoff at the site (HCI- Manual 2). In this case, the cost of retrofitting is borne by the hotspot owner, although the locality may also incur costs to find them and enforce compliance.

Stormwater managers should carefully review their existing water quality or illicit discharge ordinances to determine if they actually possess the authority to inspect and enforce compliance over the full range of hotspot sites expected in a subwatershed. If not, local ordinances should be revised to provide for this manner of retrofit delivery. Since many hotspots are small businesses, communities should also consider non-regulatory tools to improve compliance, including employee training, technical assistance and even cost-sharing (see Manual 8).

Mitigation Retrofits on Public or Private Land: This method of retrofit delivery matches the mitigation needs of private and quasi-public entities to specific storage retrofits in the subwatershed. As might be imagined, this retrofit delivery method requires exceptional interagency communication and coordination. Developers, highway agencies, utilities and others often seek opportunities to meet off-site environmental mitigation needs (wetlands, water quality trading, stormwater fees or permit conditions). Existing projects in the subwatershed retrofit inventory can be extremely attractive to permit applicants since the feasibility of the projects is already established and they are located on public land.

Over time, stormwater managers should strive to integrate their retrofit program with any stormwater mitigation, water quality trading or wetland banking efforts that may exist in the community. Most water quality experts predict that water quality trading systems will be common in the future as a cost-effective way to meet TMDLs, wastewater permits or regional nutrient limits. Care should be exercised with mitigation retrofits since they have the potential to be a zero-sum gain, particularly when both the impact and the mitigation occur in the same subwatershed (i.e., the benefit of the mitigation is cancelled out by the impact from the mitigated project). Also, the retrofitting agency may be hesitant about inheriting costly monitoring or maintenance conditions specified in a mitigation permit.

Subsidize On-site Retrofits on Private Land:

This retrofit delivery method involves targeted programs to subsidize landowners to install on-site retrofit practices on private land. Such programs go beyond mere education and normally include targeted direct technical assistance and economic incentives to make them happen. The cost of this retrofit delivery method may equal the cost of constructing several large storage retrofits, and may be financed either through grants, operating funds, or a line item in the capital budget.

About a dozen communities have subsidized on-site retrofit delivery at the neighborhood level, primarily to disconnect rooftop runoff from the combined sewer system.

Neighborhood adoption rates as high as 15 to 50% have been reported, depending on the extent of the subsidy and the convenience of the retrofit (Profile Sheet OS-10). Economic incentives include direct cash subsidies, tax credits, discounts on water bills or stormwater utility fees,

municipal installation, and provision of free rain barrels.

Trigger Retrofits as Part Public/Private Partnership: Local governments are often a major financial partner in redevelopment and rezoning projects designed to promote neighborhood or commercial revitalization. The community may subsidize development by granting payment in lieu of taxes, tax credits, low interest financing or parcel acquisition. Given the taxpayer investment in these development partnerships, the public should expect that these projects will incorporate sustainable stormwater practices and landscaping features to enhance their community benefit. Consequently, stormwater managers should maximize the use of on-site retrofits during urban design to make sure the final projects are compatible with the water quality goals of the subwatershed plan. These retrofit opportunities seldom appear in the retrofit inventory, so stormwater managers will need to frequently coordinate with local urban planners and economic development agencies to find the best targets of opportunity.

Require Stormwater Treatment for

Redevelopment Projects: If a subwatershed still has considerable development potential, stormwater managers should make sure they are imposing the most stringent stormwater criteria possible so that increased pollutant loads generated by new development do not offset loads reduced through retrofitting. If existing stormwater quality criteria are outdated, stormwater managers should update local stormwater criteria to maximize pollutant removal performance.

The infill and redevelopment process provides an excellent opportunity to achieve stormwater treatment where it previously did not exist. The amount of subwatershed

treatment that can be achieved by imposing redevelopment stormwater criteria is impressive over the long run. The urban landscape is in constant flux, with sites being continually vacated, demolished and redeveloped all the time. The same is true with public infrastructure. The design or service life of most structures and infrastructure is measured in decades, e.g., buildings (50 to 60 years), parking lots (20 to 30 yrs), bridge decks (40 to 50 yrs) and drainage infrastructure (30 to 50 yrs).

Thus, over several decades, it is quite likely that a sizeable fraction of every subwatershed will undergo redevelopment, infill, or infrastructure rehabilitation. Each of these represents an opportunity to retrofit stormwater treatment into the urban landscape. Therefore, an effective retrofit delivery strategy requires redevelopment and infill projects to address stormwater treatment in some manner. Guidance on developing effective and flexible stormwater treatment criteria for redevelopment projects can be found in CWP (2007).

Most communities are reluctant to impose more stringent stormwater criteria because of the small size, sharply higher compliance

costs, and physical constraints facing redevelopment projects. While on-site compliance is difficult, it does not imply that stormwater treatment criteria should be waived. Rather, it means that special stormwater criteria need to be developed for redevelopment projects that provide incentives to reduce impervious cover, increase forest cover, or promote the use of smart site practices during redevelopment (CWP, 2004a).

Local stormwater managers may want to consider a fee-in-lieu approach at redevelopment and infill sites. The basic concept is to waive on-site stormwater requirements in exchange for a fee that is used by the local stormwater authority to build retrofit storage elsewhere in the subwatershed. The fee is usually derived based on the cost to retrofit an equivalent acre of impervious cover using a more economical storage retrofit. In other cases, the fee-in-lieu is based on the average cost to remove a pound of nutrients. Several communities have adopted a fee-in-lieu as an equitable and cost-effective way to treat runoff from small urban sites. Guidance on setting an appropriate fee schedule can be found in Winer (2003).

Chapter 2: 13 Subwatershed Locations Near You

This chapter outlines some practical ways to find retrofit storage in 13 different locations in a subwatershed. Thirteen profile sheets describe how to find, assess, design and construct retrofit storage. This locational approach to retrofits helps designers to

envision restoration opportunities throughout urban subwatershed. Figure 2.1 illustrates the best locations for both storage and on-site retrofit practices. Each location presents different opportunities and challenges to successfully obtain retrofit



Figure 2.1: Various locations for both storage and on-site retrofits

storage. Table 2.1 compares differences between each retrofit location, in terms of how easy they are found, simplicity of design, ease of permitting/approvals and treatment costs. As can be seen, storage retrofits are generally easier to find and have low treatment costs, although their design and permitting is more complex. By contrast, most on-site retrofits are harder to find and have moderate to high treatment

costs, although they are generally easier to design and get permitted.

The retrofit team should carefully choose which subwatershed retrofit locations to investigate when scoping their initial retrofit effort. The general capability of each retrofit location to provide various kinds of stormwater treatment is depicted in Table 2.2.

Table 2.1: Comparison of Retrofit Locations				
Subwatershed Location	Retrofit Design Issue			
	Easy to find from desktop?	Simple to design?	Easy to get permits?	Low treatment cost?
SR-1 Add Storage to Existing Ponds	●	○	⊙	●
SR-2 Storage Above Roadway Culverts	●	○	○	●
SR-3 New Storage Below Outfalls	⊙	○	⊙	⊙
SR-4 Storage In the Conveyance System	⊙	○	⊙	⊙
SR-5 Storage in Transport Right-of-ways	●	○	⊙	●
SR-6 Storage Near Large Parking Lots	●	○	⊙	⊙
OS-7 Hotspot Operations	○	⊙	●	○
OS-8 Small Parking Lots	⊙	⊙	●	⊙
OS-9 Individual Streets	○	⊙	●	○
OS-10 Individual Rooftops	○	R● N⊙	R● N⊙	R⊙ N○
OS-11 Little Retrofits	○	●	●	●
OS-12 Landscapes/Hardscapes	○	●	●	⊙
OS-13 Underground	○	○	⊙	○

Key: ● Yes ⊙ Moderate ○ No
R = Residential N = Non-residential

Table 2.2: Retrofit Options and Stormwater Treatment Provided				
Subwatershed Location	Stormwater Treatment Provided			
	Water Quality	Runoff Reduction	Channel Protection	Flood Control
SR-1 Add Storage to Existing Ponds	●	○	●	○
SR-2 Storage Above Roadway Culverts	●	○	●	⊙
SR-3 New Storage Below Outfalls	●	⊙	⊙	⊙
SR-4 Storage In the Conveyance System	●	⊙	⊙	⊙
SR-5 Storage in Transport Rights-of-ways	●	⊙	●	⊙
SR-6 Storage Near Large Parking Lots	●	⊙	●	⊙
OS-7 Hotspot Operations	●	○	○	○
OS-8 Small Parking Lots	●	●	⊙	○
OS-9 Individual Streets	●	●	⊙	○
OS-10 Individual Rooftops	⊙	●	○	○
OS-11 Small Impervious Areas	●	●	○	○
OS-12 Landscapes/Hardscapes	●	⊙	○	○
OS-13 Underground	●	⊙	○	○

Key: ● Full ⊙ Partial ○ Rarely

Each retrofit profile sheet follows a common organization:

Basic Description – This section describes where the retrofit fits into the landscape, how it works, and which stormwater treatment options are most commonly used.

Ideal Conditions for the Retrofit – This section notes the site conditions that lead to a successful retrofit at that location.

Situations Where the Retrofit Is Difficult – This section outlines common site constraints that can indicate a retrofit is difficult or impossible to implement at that location.

Alternative Restoration Projects – This section outlines alternative restoration projects that may be worth pursuing when a retrofit is not feasible at a site.

Desktop Searches for Good Locations – Simple GIS and mapping tricks can help narrow down the list of potential subwatershed retrofit locations to a manageable number. This section presents guidance on how to quickly and efficiently find candidate retrofit sites to investigate in the field.

What to Look For When Investigating Sites – This section provides field crews with step by step guidance on how to investigate retrofit feasibility in the field. Detailed tips are offered on how to determine available treatment area, assess site constraints and develop a concept plan.

Typical Feasibility, Approvals and Permitting – Many hurdles must be overcome to build retrofit projects. This

section outlines the most common feasibility, approval and environmental permits that come into play at each location, along with tips and strategies to secure them.

Retrofit Design – This section outlines key issues for the team to consider in the retrofit design process and the range of special studies that are needed to support it. The section concludes with a step by step design process for each retrofit location.

Construction Considerations – Retrofit construction is always challenging. This section helps designers anticipate and address common construction problems at each retrofit location.

Retrofit Delivery Issues – Many on-site retrofits are needed to make a difference in a subwatershed, so this section presents effective strategies to deliver them on a widespread basis. Tips are also given on how to multiply on-site retrofit delivery through education, incentives, and outsourcing methods.

Construction Cost – Each retrofit location has a unique construction cost, which must be understood to rank and prioritize the most cost-effective retrofits for a subwatershed. This section presents median retrofit construction cost estimates to use for planning purposes during concept design. Cost ranges are also presented, along with site-specific factors that can increase or decrease the cost of individual retrofits to further refine cost estimates.

SR-1	Storage Retrofits	
	MODIFY EXISTING PONDS	

The first place to look for retrofit storage is within existing ponds. Stormwater ponds are an extremely attractive retrofitting target, particularly when they have existing dry detention or flood control storage. The most common approach is to combine extended detention, wet pond or constructed wetland storage to improve water quality. In other cases, bioretention can be provided in the bottom of dry ponds. Some ponds may have enough capacity to provide C_{pv} to protect downstream channels from bank erosion. Even modern ponds can be enhanced by retrofits.

Five strategies can be used to retrofit storage into an existing pond:

- Excavate the pond bottom
- Raise the embankment
- Modify the riser
- Steal existing flood control storage
- Fix internal design geometry and/or add forebay

Designers often combine several strategies together to enhance the performance of existing ponds (Figure 1).

Pond retrofits are ideal since land costs are minimal, and construction costs are about 40% less than a new retrofit pond. In addition, since the land is already devoted to stormwater management, most easements are already in place. Pond retrofits also need fewer permits and approvals compared to other storage retrofits. Pond retrofits are often favored by adjacent residents since

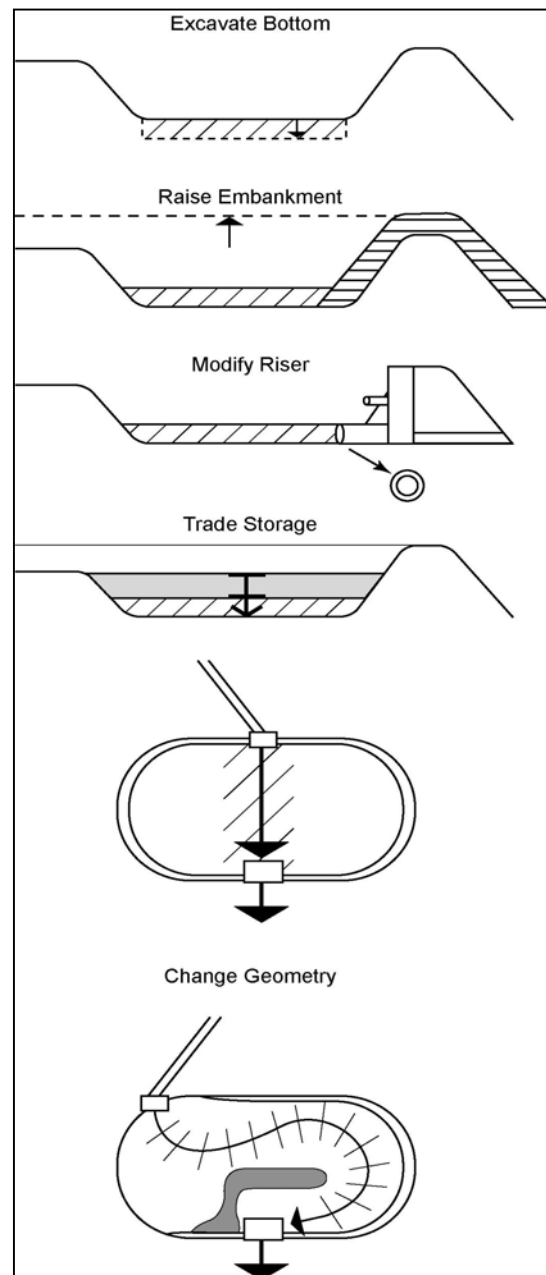

Figure 1: Five strategies to retrofit a pond

they correct maintenance problems and improve pond appearance.

Ideal Conditions for Pond Retrofits

The following types of ponds are ranked in descending order of retrofit potential.

- Regional flood control or detention ponds
- Dry stormwater detention ponds
- Dry extended detention ponds
- Farm and ornamental ponds
- Public golf course ponds
- “Modern” stormwater quality ponds

Another way to analyze pond retrofit potential is to understand the different eras and corresponding design standards under which ponds were built in a community over time. The precise evolution of stormwater pond design differs in each community and should be investigated during the retrofit scoping process. Most communities have followed the following general sequence of stormwater management. Stormwater systems constructed prior to 1970 were primarily comprised of underground pipes, with limited surface land devoted to a few large flood control projects. Between 1970 and 1990, however, many communities built large stormwater detention ponds to control peak flood discharges. Detention ponds in this era often have great retrofit potential for water quality or even channel protection (Figure 2).

Ponds constructed in recent years were designed to treat stormwater quality, and therefore have less retrofit potential. They

are still worth investigating, however, since many suffer from basic design flaws that impair their performance (single cells, multiple inlets, short-circuiting, short flow paths and lack of wetland features). Indeed, synoptic studies of recent stormwater ponds constructed in the field suggest that as many as 90% of “modern” ponds have significant design flaws (Figure 3).

Situations Where Pond Retrofits Are Difficult

Several conditions can make it hard to retrofit a pond:

- Older and/or highly urban subwatersheds where development occurred prior to the advent of stormwater pond requirements
- Dry ponds that have utilities running through the pond bottom or are used for dual purposes (e.g., recreational ball fields)
- Older ponds that have lost their original flood storage capacity due to additional upstream development, sediment deposition or both
- Stream corridors with flood prone structures present in the flood plain
- Landlocked ponds that cannot be accessed by construction equipment



Figure 2: Older stormwater detention ponds are an attractive retrofit target



Figure 3: The performance of many “modern” ponds can be improved through retrofitting

Alternative Restoration Practice at Pond Sites

Even when a pond retrofit is not feasible, other restoration practices may be suitable for the site:

- Tree planting within acceptable portions of the pond and its buffer (Cappiella *et al.*, 2006a)
- Planting wetland plant species in pond benches
- Notifying owner to perform maintenance tasks to restore pond function
- Including the pond in a local Adopt-a-Pond program (Sturm, 2003)

Desktop Searching for Pond Retrofits

Pond retrofit sites can be quickly found if a community has a good GIS database that shows surface land devoted to stormwater

practices. These maps should be closely scrutinized to look for ponds with contributing drainage areas greater than 5

acres. Some communities lack maps or databases of their stormwater infrastructure.

In these situations, pond retrofit sites can be discovered by analyzing recently flown aerial photos (Figure 4).

Dry ponds are among the best retrofit sites, so the presence of water alone is not always a good retrofit indicator. It is helpful to define the age of subwatershed development to find areas built within a particular stormwater design era that is well suited for retrofitting. Some designers go further and analyze topography at potential pond sites to get a first estimate of the contributing drainage area.

Once a subwatershed has been scanned for decent pond sites, the next step is search through local stormwater agency files to see if original as-built drawings or design computations exist. Few communities have digitized pond design review files for older ponds that are best suited for retrofits. Some designers may put off this search until after



Figure 4: Dry ponds are easy to pick up on fine resolution aerial photos

the field reconnaissance to ensure that a pond retrofit is indeed feasible for the site.

What to Look for when Investigating a Pond

The first step during a retrofit reconnaissance is to check out the existing plumbing of the pond and compare it to as-built drawings, if they exist. The crew should quickly check the:

- Condition and elevation of pond inlet(s), internal flow path, outlet, riser and emergency spillway.
- Condition of pond outlet to determine if it is damaged or prone to clogging.
- Changes in the pond since it was originally constructed, such as excessive sediment deposition, maintenance problems or woody growth.
- Physical integrity of the dam or embankment, looking for signs of seepage, settlement, sloughing or animal burrows.

Next, the crew walks above and below the pond to:

- Look at upstream pipes or channels for possible headwater effects
- Look downstream of the pond outfall for possible scour problems to correct
- Quickly verify the contributing drainage area, particularly when multiple inlet pipes are present.

The last step of the pond reconnaissance involves choosing which combination of the five pond retrofit strategies will produce the most cost-effective treatment storage. The crew evaluates the feasibility of each retrofit strategy by looking at:

Excavating the pond bottom – The crew checks the bottom of the pond to see if it can

be excavated to provide more storage. The ideal situation is a dry, flat pond bottom with no evidence of standing water. Use a soil auger to check for moisture and presence of hydric soils.

Raising the embankment – The crew looks for available space at the toe of the embankment to determine if there is enough room to support the wider footprint needed to raise embankment height. The crew should also quickly check the proposed new embankment elevation against the invert elevation of pond inlet pipes to assess potential for tailwater problems.

Trading storage – The crew then looks for multiple riser outlets which may indicate detention storage for design storms in the 2 to 25 year range (Figure 5). In many cases, the storage for these design storms can be converted to provide water quality treatment.

Modifying the pond riser - The best situations are dry detention ponds that have a large diameter low flow outlet that can be constricted by attaching an orifice plate, an anti-vortex device and appropriate trash rack. A weir wall can also be used to provide the restriction (Figure 6). If a concrete riser is present, check to see if more weir capacity is needed to pass larger overbank and extreme storms. Try to get a general sense whether the existing detention pond is over-sized.

Modifying internal design – The crew should check to see whether the internal flow path can be extended, wetland elements added, or a forebay installed.



Figure 5: Multiple outlets are a clue that storage trading is a possibility



Figure 6: A dry pond retrofit may include the installation of a weir wall

Feasibility, Permitting and Approvals for Pond Retrofits

Pond retrofits normally involve fewer environmental permits and landowner approvals than other storage retrofits, but may require several analyses.

Since retrofits will modify pond hydraulics, designers often need to secure dam safety permits, particularly if the dam hazard classification changes or the dam was never permitted to begin with. Pond safety standards vary regionally, so check with the appropriate local or state dam safety review authority. In many cases, dam safety criteria may have changed since the pond was originally built, so significant upgrades to the riser, embankment or emergency spillway may be needed to conform to newer and more stringent standards.

Pond retrofits that require conversion of flood storage into water quality storage may result in partial loss of 2, 5 or 10 year peak discharge control. While this may not materially affect the pond's flood control function, designers will need approval from the local stormwater review authority. The authority may require additional hydraulic modeling to ensure that proposed retrofit will not harm downstream property or structures. A dam breach analysis may also be required.

Landowner permission may be needed to retrofit privately-owned ponds. Owners may be willing to grant permission, since the land is already dedicated for stormwater, prior easements may exist, and the retrofit may upgrade the condition of the existing pond.

If the pond retrofit converts dry storage to wet storage, it is important to determine whether an adequate water balance exists to maintain a permanent pool at a constant water elevation. Under-sized pond retrofits that have fluctuating water levels are unsightly and may create nuisance problems. Converting dry storage into wet pond and/or constructed wetlands can also create real or perceived concerns about mosquitoes, drowning, tree loss and resident geese on the part of adjacent residents and landowners.

Some responses to these concerns are provided in Chapter 4.

Designers should not automatically assume that pond retrofits do not require wetland, waterway disturbance or forest conservation permits. Portions of older ponds may have evolved into forest or wetlands, so check with local and/or state permitting agencies to determine their current regulatory status. While utility conflicts are not common in most ponds, sewers may exist underneath (Figure 7).

The feasibility of pond retrofits that rely on excavation is often a matter of earthwork balance. Some designers will prepare a rough grading plan during concept design to determine whether earthwork balance at the proposed retrofit is reasonable by looking at the proposed depth of grading and the

required minimum pond side slopes that must be maintained.

Pond Retrofit Design Issues

Pond retrofits have unique design issues compared to new pond construction:

Pond retrofits are challenging when there is limited room to squeeze in the target WQv storage and also include modern pond design features. Forebays, micropools and benches all tend to reduce the already limited treatment volume available at the pond retrofit. As a general rule, designers should compromise on storage before they dispense with design features related to performance, maintenance access or safety. Examples of good pond retrofits that incorporate key design features are shown in Figures 8 and 9.



Figure 7: Conflict with a major sewer was avoided by using a berm and a three cell design in this retrofit.

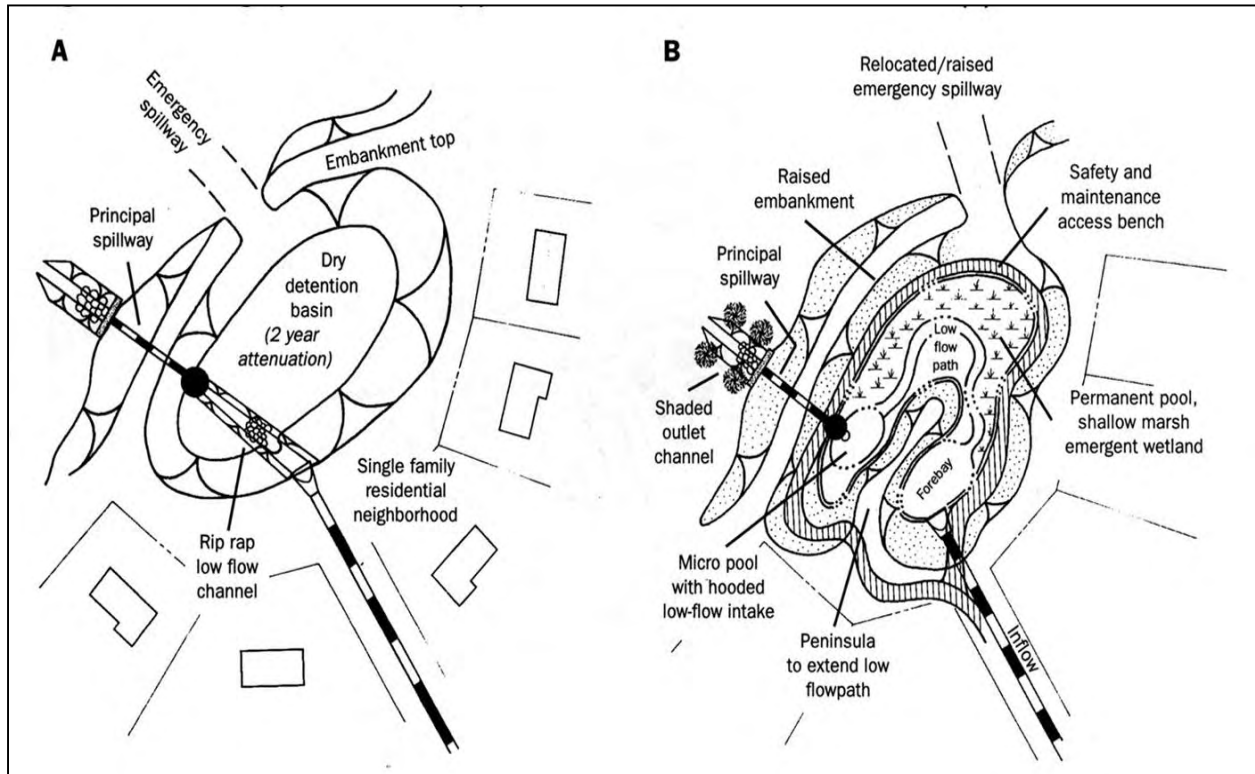

Figure 8: Schematic showing conversion of a dry pond to a shallow marsh



Figure 9: The Rolling Stone retrofit: before and after

Earthwork balance is often tough at pond retrofits since there is little room to spoil excavated material on-site, and soggy soils may not be suitable for embankment fill. Designers need to be creative in keeping material on-site, since off-site hauling of wet sediments can be very expensive. Designers should look for areas at the site where excavated sediments can be de-watered prior to spoiling or hauling. Pond retrofits should include access roads to enable heavy equipment to reach forebays and outlet works to perform maintenance. Designers should avoid using ED as the sole stormwater treatment option at a pond retrofit site. Extensive pond and buffer landscaping should also be a design priority to enhance neighborhood acceptance. Pond retrofits should include signs to educate residents about the stream protection benefits they provide.

Most research suggests that ponds do not cause major mosquito breeding problems and can provide habitats for their predators. Still, designers should include measures that maintain constant outflows, create habitat for predator fish, and provide aquatic benches to support emergent vegetation.

Designers may need to secure temporary or permanent easements for construction and maintenance access, if they were not reserved as part of original pond construction. Pond retrofits can alleviate chronic maintenance problems at failing stormwater practices. Figure 10 shows how a clogged infiltration basin was converted into an extended detention pond with a micropool.

Design Support

Soil borings generally make or break a pond retrofit, and reveal important clues about their feasibility and cost. Soil borings help:



Figure 10: Retrofitting can improve the function of this failed highway practice.

- Ascertain the physical characteristics of excavated material
- Determine its adequacy for use as structural fill or spoil
- Define the depth to groundwater and/or bedrock
- Provide data to develop structural designs for outlet works (e.g., risers and weir walls).
- Determine potential excavation problems and issues with embankment integrity

Several soil borings should be taken along the embankment and the bottom of dry ponds. Soil cores may be needed to ascertain the quality and consistency of bottom sediments in wet ponds.

Other design support needed for modeling pond retrofits includes:

- Updated aerial photos to define the land cover for the contributing drainage area (particularly if it has changed since the pond was first constructed).
- Surveys to define current hydraulic cross-sections of the storm drain network leading to the pond.
- Survey crews may need to establish the current bathymetry, storage and pipe/riser elevations for the pond, if as-built drawings do not exist.

Pond Retrofit Design Process

The retrofit design process analyzes the existing hydrologic and hydraulic characteristics to find opportunities to obtain greater WQv and Cpv storage. Some examples of retrofits created by reallocating storage are shown in Figure 10.

The complexity of the pond retrofit design process depends on the nature of the proposed pond alterations. For example,

retrofits that merely install forebays or trash racks, or plant wetland benches do not require detailed retrofit design. Any retrofit that reduces existing flood control storage volume, changes pond storage allocations, alters water elevations, or influences riser performance should undergo the following basic design process:

Step 1: Determine the design objective for the retrofit (e.g., WQv and/or Cpv). Analyze the original design computations/plans to determine the original design objectives for the existing pond (e.g., 2 year, 10 year, 100 year peak discharge control). Check with local review authority to determine whether any existing peak discharge storage can be converted into WQv storage. Existing storage can be reallocated to WQv and Cpv storage as long as it does not create unacceptable downstream flooding conditions. The designer should consult with the local stormwater review authority to determine the hydraulic/hydrologic modeling requirements, as well as the appropriate design storms.

Step 2: Compute the target WQv and/or Cpv storage volume for the proposed retrofit (in acre-feet), based on current drainage area and impervious cover.

Step 3: Determine which combination of the five pond retrofit strategies can be employed at the retrofit to achieve the desired target storage volume. This is done iteratively by analyzing contours of new pond dimensions created by excavation or analyzing the pond's existing stage/storage/discharge curve. Once the designer is confident that the target volume can be obtained, they can begin pond modeling.

Step 4: The designer should analyze existing pond computations to create a new model. Model inputs may need to be updated to

reflect changes in contributing drainage area, land use, or storm drain infrastructure leading to the pond. In addition, the original pond dimensions and water surface elevations may need to be revised if topographic or bathymetric surveys indicate they have significantly changed. This is particularly common for older wet ponds where past sediment deposition may have reduced pond capacity.

Step 5: Model the hydrology and hydraulics of the existing pond using the new input deck to determine if it still meets current stormwater and dam safety criteria.

Step 6: Redo pond contours (if re-grading or excavation is anticipated), modify riser dimensions and alter appropriate water surface elevations to conform to the proposed retrofit. Check to make sure they collectively meet target volumes.

Step 7: Route the appropriate design storms through the new pond retrofit and analyze effect on riser performance, water surface elevations, and downstream flooding conditions. This is normally an iterative process.

Step 8: Provide specifications for retrofit design features

Construction Considerations for Pond Retrofits

The construction sequence for pond retrofits can be fairly complex and include the following elements:

- Check construction access routes to the retrofit to determine if any curbs, pavement, manholes, landscaping or other site features will be disturbed during construction and will require repairs.

- Pond retrofits often have limited space for temporary stockpiling and construction staging. In some cases, there may be no alternative but to store equipment within the pond, which may increase the risk that it will be damaged during flood events.
- Clearing/grubbing may be needed for construction access if trees have grown up because the pond has not been regularly mowed.
- Dewatering of bottom sediments and pumping are needed at many pond retrofits to manage groundwater inflow during the excavation process (Figure 11). The proper disposal of these muddy waters must be addressed in the erosion and sediment control plan.
- Temporary diversion of both stormwater runoff and baseflow is generally needed during construction. Cofferdams can be constructed within the pond to isolate construction areas and bypass pond inflows.



Figure 11: Dewatering is needed to excavate bottom sediments.

- A complex construction sequence is needed when embankments are reinforced or outlet structures are replaced. The erosion and sediment control plan will need to be carefully phased to prevent pond sediment from being discharged.
- Fencing and signs should be posted around the limits of disturbance and staging areas to minimize public access during construction.
- If the retrofit forebay is under-sized, accelerate the sediment removal schedule in the maintenance plan (Figure 12).

Typical Costs for Pond Retrofits

Construction cost can be challenging to calculate for pond retrofits, although modifying an existing pond is generally cheaper than constructing a new pond. A planning level cost estimate for converting an existing dry pond into a wet pond or constructed wetland is provided in Table 1. Costs will also vary from region to region based on prevailing labor rates. Several site factors that tend to drive up or reduce construction costs are detailed in Table 2.



Figure 12: This under-sized forebay filled up with sediment within five years of retrofit construction.

Table 1: Estimated Construction Costs for Pond Retrofits (2006 \$/impervious acre treated)			
Retrofit Type	Median Cost	Range	Design & Engineering (%)
Modify Existing Pond ¹	\$ 11,150 ²	\$ 3,600 to \$37,000	32 ³
¹ Does not apply to simple changes in pond geometry or enhanced pondscaping ² Adjust based on site-specific construction cost inflators/deflators in Table 2 ³ Use a 40% value in major environmental or dam safety permits are needed			

Table 2: Site-Specific Factors that Influence the Cost of Pond Retrofits	
Factors that Decrease Cost	Factors That Increase Cost
<ul style="list-style-type: none"> • Available weir space • Neutral earthwork balance • Simple adjustment to low flow pipe in riser • Existing pond is dry • No major changes to riser or embankment • 2 or 10 year storage can be sacrificed • No utility conflicts • Wide setback from pond to structures • No wetland or in-stream permits needed • Existing access is adequate 	<ul style="list-style-type: none"> • Changes to concrete risers or replacement • Need to haul excavated material offsite or import fill to the site • Working in-stream/pond baseflow • Existing pond is wet or has saturated soils; dewatering needed to excavate bottom • Change in dam safety classification • Embankment reinforcement needed • Land-locked ponds with poor access • Wetland mitigation needed for project • New access ramps must be installed

SR-2	Storage Retrofits	
	STORAGE ABOVE ROADWAY CROSSINGS	

Road crossings can be modified to provide temporary water quality storage above an existing road culvert. Storage is obtained by installing a new embankment above the crossing to get “free” storage (Figure 1). The new embankment protects the roadway embankment from seepage effects. Available storage can also be increased by excavating areas adjacent to the upstream channel. In general, crossing retrofits are applied to non-perennial stream channels to avoid permitting problems (i.e., zero and first order streams).

A control structure is normally installed through the new embankment that connects with an upstream micropool (Figure 2). The control structure typically consists of a gabion or concrete weir or a riser/barrel. The micropool has a small permanent pool sized to be at least 10% of the total WQv.

Extended detention, constructed wetlands and wooded stormwater wetlands are recommended treatment options for crossing retrofits (see Figure 3). Road crossings may also contain enough storage to provide channel protection storage. Crossing retrofits are ideal because they take advantage of free upstream storage, which reduces excavation costs. Crossing retrofits are complicated because many environmental permits and landowner approvals are needed to construct them.

Ideal Conditions for Crossing Retrofits

The best situation for a crossing retrofit is when:

- The existing culvert has sufficient hydraulic capacity to pass desired storm flows.
- Upstream land is in public ownership .
- Channel has ephemeral flow (e.g., zero or first order stream).
- Upstream channels are low gradient, are connected to the floodplain, and have short streambanks.
- The retrofit is timed to coincide with scheduled repair/replacement of the existing culvert.
- The retrofit is upstream of a proposed stream restoration or wetland mitigation project.

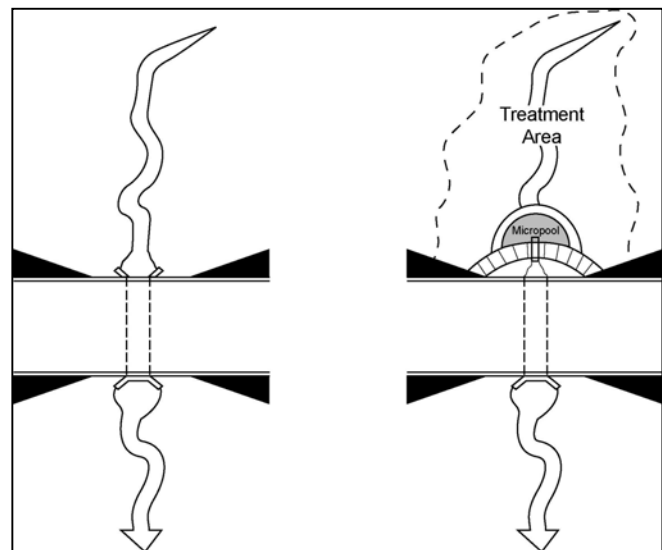

Figure 1: Strategy for getting free storage above a road crossing

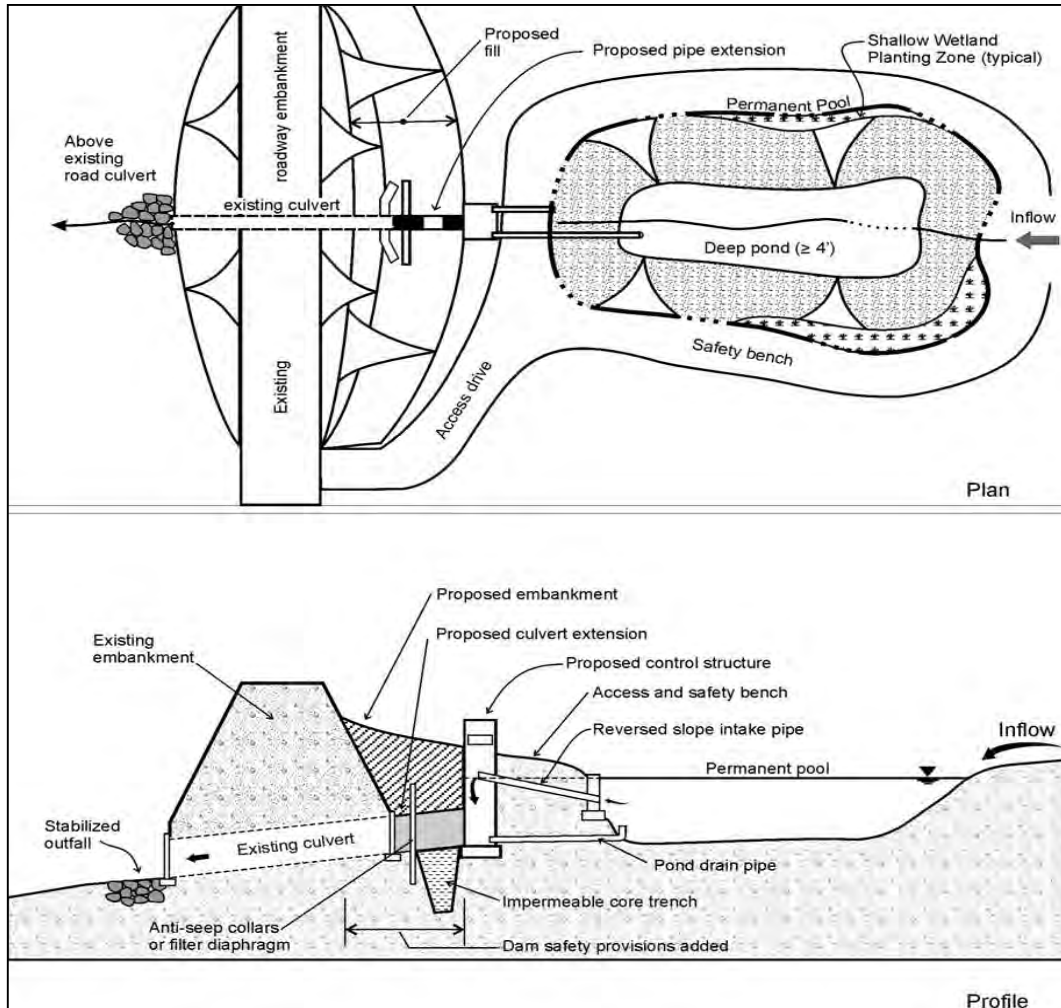

Figure 2: Typical plan and profile of crossing retrofit showing secondary embankment

Situations Where Crossing Retrofits are Difficult

Crossing retrofits are generally not a good option when the:

- Existing culvert lacks hydraulic capacity but is not scheduled for replacement.
- Stream has perennial or intermittent flow (e.g., second order stream or larger) or is used by migratory fish.
- Proposed upstream storage area contains high quality wetlands or mature forests.
- The project storage area contains sewer lines or other utilities that often run adjacent to streams or parallel to the road.
- Contributing drainage area to the crossing is greater than 250 acres
- Upstream channel has a steep gradient, is deeply incised, or has a confined floodplain.
- Existing structures encroach into the floodplain and would be subject to a greater flooding risk.

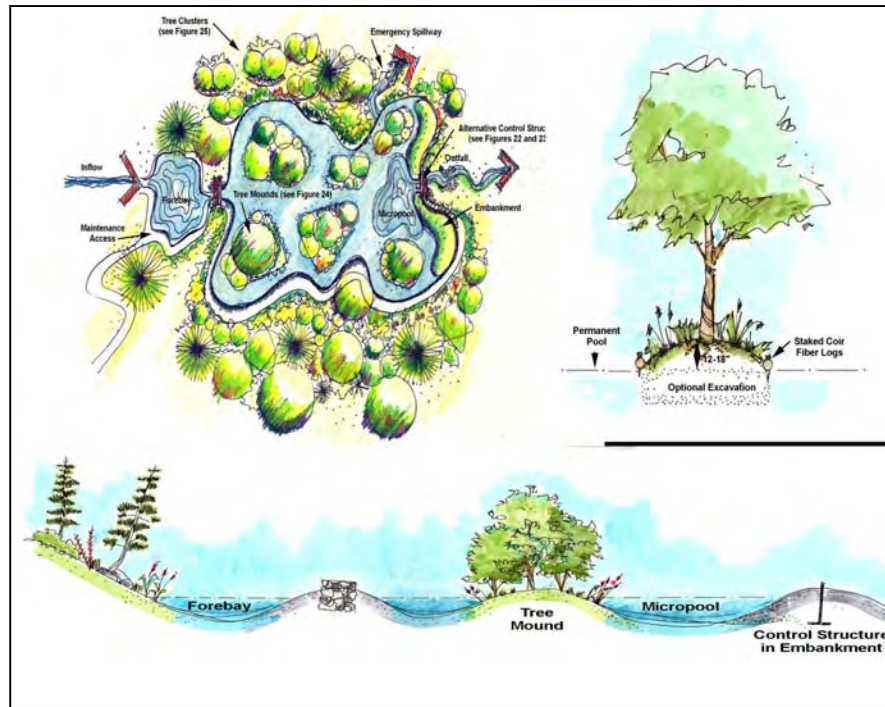

Figure 3: Wooded wetlands are a preferred stormwater treatment option for crossing retrofits.

Alternative Restoration Projects at Crossing Sites

Road crossings are a prime location for many restoration practices, even when a crossing retrofit is not feasible. Designers may wish to consider:

- Upstream wetland restoration
- Culvert repair or replacement (see Profile Sheet R-27 and R-28 in Manual 4)
- Culvert modification to increase tidal flushing in coastal creeks or wetlands
- Fish barrier removal (see Profile Sheet R-30 in Manual 4)
- Downstream stream repair (see Manual 4)
- Riparian reforestation
- Stream adoption (see Profile Sheet C-2 in Manual 4)

Desktop Searching for Crossing Retrofits

Road crossings are generally quite easy to spot on fine-resolution aerial photos or maps (Figure 4). If good GIS data are available to characterize the drainage network, headwater stream layers (zero, first and second order) can be superimposed over the local and state road network to locate



Figure 4: Crossing retrofits are easy to find when road network and drainage layers are superimposed.

potential sites to visit in the field. Ditch lines and headwater streams do not show up well on most maps, so designers may need to define them based on topography above the crossing. If topography is available, it is relatively easy to derive an initial estimate of the contributing drainage area to the proposed retrofit (which some designers may want to know before going out in the field). If a Unified Stream Assessment has already been completed in the stream corridor, the team may want to review the stream crossing (SC) impact forms to find potential sites.

What to Look for When Investigating Crossing Retrofits

The feasibility of crossing retrofits can be quickly determined by assessing the culvert, upstream storage conditions, and downstream conflicts (Figure 5):

1. Evaluate the culvert - The crew should check out the existing plumbing of the culvert to determine its:

- Alignment in relation to the stream
- Invert elevation in relation to the road
- Culvert diameter, material, and condition (including headwalls and endwalls)
- Sediment deposition within the culvert that may reduce its hydraulic capacity.

Next, the crew assesses how easy it will be to get construction equipment down the steep slopes from the roadway embankment to the retrofit. If the elevation difference is minor, it may be possible to construct an access ramp. Many underground utilities often run parallel to the road, so the crew should look for surface utility indicators such as manholes or venting stacks.

2. Evaluate upstream storage potential - The crew then estimate the potential storage volume available upstream. The best way to do so is to envision a triangle with its base parallel to the road crossing and its apex at the point upstream at the same elevation as the roadbed. Walking upstream, the crew paces off the distance to the apex, and then walk in a perpendicular direction to each bank until the roadway elevation is attained. Using this method, the crew can get a rough measure of the boundaries of available surface area (Figure 6). Using a tape measure and lock level, the crew then records the vertical distance from bottom of the culvert pipe to the roadbed. The acre-feet of free storage can then be determined based on the geometry of the prism.

The crew can use a hand auger to get a quick sense of whether the floodplain soils are suitable for excavating additional storage (or whether wetland indicators are present that may cause permitting problems). Lastly, the crew should note any wetlands, mature forest cover or underground utilities that might reduce the available treatment area.



Figure 5: Field crews measure culvert dimensions and examine upstream and downstream conditions.

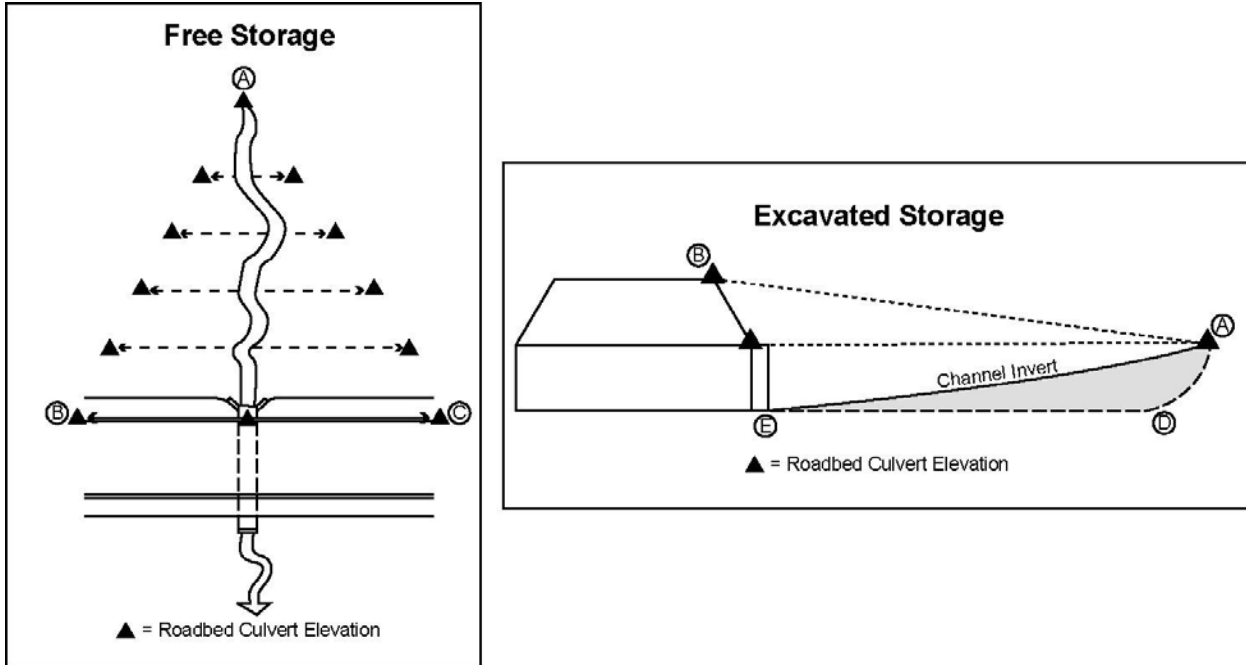

Figure 6: Estimating free storage using the triangle approach

Crews estimate the area of free storage by visualizing an ABC triangle extending with its base parallel to the road and its apex at the upstream elevation as the roadbed (panel a). The depth of free storage is defined by the triangle BEA (panel b) plus any additional excavated storage defined by the EDA triangle.

3. *Understand downstream conditions* - The crew then turns its attention to the downstream end of the culvert, and measures the vertical distance from the culvert invert to the stream bed, and quickly estimates the rate of flow over the culvert lip (if any). The crew records whether a scour hole exists immediately below the culvert, and whether it is acting as a stream grade control. The crew may need to walk several hundred feet downstream to get a sense of stream morphology and look for any flood prone structures in the stream corridor.

environmental permits related to fish passage, forests, floodplains, wetlands and waterway construction. Most permitting agencies are understandably reluctant to allow embankments or other obstructions to be placed across perennial streams. Some agencies may permit crossing retrofits if the existing stream is highly altered or channelized, and does not support aquatic life. The best permitting situation is when the stream is first order or smaller, and has negligible flow. Additional guidance on environmental permits is provided below.

Feasibility, Approvals and Permitting for Crossing Retrofits

Crossing retrofits have many permitting and approval hurdles. The in-stream nature of crossing retrofits triggers numerous

Crossing retrofits nearly always require wetland and waterway disturbance permits as many stream channels are regarded as jurisdictional under Sections 401 and/or 404 of the Clean Water Act. The stream corridor in the proposed retrofit area may contain riparian wetlands that are also subject to the same permits. If stream channels or riparian wetlands are high quality and have functional value, the site should be dropped from consideration. It makes little sense to degrade the function of an existing watershed element in order to restore a new one.

Designers should also consider how future inundation in the proposed retrofit area will affect the quality of existing forests or wetlands (Figure 7). Research has shown that stormwater ponding and water level fluctuations degrade wetland quality (Wright *et al.*, 2007). Similarly, chronic inundation can kill sensitive tree species (Cappiella *et al.*, 2006b). Even though hydrological changes are not technically regulated under most state and federal wetland protection programs, ethical retrofit designers should never degrade the quality of existing forests and wetlands.

Fish passage is a key issue to assess at crossing retrofits. State fishery biologists should be consulted to determine if migratory or resident fish are currently using the upstream segment. The existing culvert often acts as a barrier to upstream fish migration, but if fish are present, the retrofit should be dropped from consideration. Instead, designers should investigate whether culvert repair or replacement is a viable option at the crossing (see Profile Sheets R-27 to R-29 in Manual 4).

Crossing retrofits can potentially increase floodplain elevations above or adjacent to the proposed treatment area. Many zero and first order streams lack a defined or regulatory floodplain, but if one exists, designers may need to secure a permit from the local or state floodplain management authority.

The second key hurdle is getting approval from the local or state highway review authority to modify roadway embankments or culverts and secure easements needed for construction and maintenance access. The highway agency will certainly want to ensure that the proposed design will not saturate existing roadway embankments nor change the condition and flow capacity of



Figure 7: Sedimentation and increased water level fluctuation can harm sensitive forests and wetlands.

the existing culvert. Designers should coordinate closely with highway review staff early in the design process, particularly if the control structure is located outside of their right-of-way or will be maintained by a different party.

The highway agency will want to know who is responsible for maintenance and how it will be paid for. The most common arrangement is a maintenance agreement between the highway agency and the local public works department, although in some cases, a third party landowner might be involved. The highway agency will expect a written maintenance agreement that clearly defines the duties, schedules and contingencies for future maintenance.

Crossing Retrofit Design Issues

The design of crossing retrofits entails the following unique design issues:



Figure 8: Designers should anticipate clogging problems by woody debris at crossing retrofits.

Crossing retrofits are particularly prone to clogging by organic debris, woody vegetation and sediment delivered from upstream sources (Figure 8). Over-sized forebays or micropools are strongly recommended. Trash racks are also needed to protect the control structure and require careful design so that they don't get clogged by woody debris. Reverse slope pipes extending to mid-depth of the micropool are often a good design solution.

Safe and easy access to the micropool or forebay must be provided, as both need to be frequently maintained to remove accumulated sediment and debris. Specialized equipment that can access tight sites may be needed to remove trapped materials.

Another key issue is how to minimize the amount of excavation needed for a crossing retrofit while still achieving the desired water quality volume. Off-site hauling of excavated materials can be very expensive, so designers should try to maximize "free" storage and look for nearby areas where excavated soils can be spoiled without losing treatment or floodplain capacity.

The design of each crossing retrofit should always be done in the context of downstream geomorphology. Designers should evaluate whether downstream stabilization and/or grade control are needed to protect the crossing retrofit.

Design support

Crossing retrofits require numerous studies to confirm their feasibility and support final design:

- The contributing drainage area to the crossing retrofit should be accurately delineated using GIS or CAD. If

boundaries are questionable, they should be ground-truthed.

- Any forest or wetlands that will be disturbed or inundated by the retrofit should be delineated and their functional value assessed (Figure 9). Designers should consult foresters to determine what upstream tree and wetland species might be harmed by chronic inundation and/or ponding.
- Soil borings should be taken on the embankment, in the vicinity of the proposed control structure and at two points within the proposed treatment area. As a general rule, alluvial material is not useable as structural fill. Soil borings are critical to assess retrofit constructability factors, such as:
 - bearing capacity of risers
 - potential use of fill
 - compaction/composition of embankment
 - depth to groundwater
- Designers should obtain the original culvert design file and review any upstream calculations that exist. If the



Figure 9: Surveys of forest and wetland conditions should always be performed in the proposed treatment area.

pipe/channel network has changed since the culvert was installed, designers should survey upstream channel cross-sections and elevations.

- Downstream studies may be needed to assess the impact of the proposed retrofit on fish passage, stream geomorphology or floodplain elevations. Designers should consider whether the retrofit will alter the sediment regime enough to actually increase the potential for downstream channel erosion. If a retrofit effectively captures sediment bed load, it may starve the downstream channel and create a “hungry” stream.

Design Process

The design process for crossing retrofits is generally done in a step-wise process:

Step 1: Check with the appropriate review authority to determine what design storms the culvert is expected to pass.

Step 2: Determine the target WQv or Cpv storage needed at the retrofit based on current drainage area and impervious cover, and compare to the estimated acre-feet of storage that can be obtained behind the secondary embankment (i.e., free storage and excavated storage).

Step 3: Model current upstream hydrology delivered to the culvert based on prior computations. New model input parameters may need to be derived if upstream land use, drainage divides, or storm drain infrastructure has changed since the crossing was originally designed.

Step 4: Run the appropriate design storm flows through the culvert to determine if it has adequate capacity to meet current hydraulic design criteria. If so, proceed with

upstream pond design. If not, investigate whether culvert replacement might be integrated into the overall retrofit design.

Step 5: Determine where the control structure will be located and determine the most appropriate material and elevations for the secondary embankment. Evaluate retrofit dimensions to verify that the storage obtained still meets the minimum target volume.

Step 6: Route design storms through the secondary embankment and old culvert to confirm they still meet current standards for design capacity. A dam breach analysis may be needed, depending on the height of the secondary embankment and its proximity to the roadway.

Step 7: Check how proposed water elevations will influence utilities and other structures in the floodplain. Compare manhole elevations to the proposed retrofit surface elevations to avoid the submerging sanitary system.

Step 8: Perform any additional analyses requested by the highway review authority.

Construction Considerations for Crossing Retrofits

Crossing retrofits involve several construction considerations that are not often associated with standard stormwater ponds (Figure 10):

- Staging and access are always challenging at crossing retrofit sites, given steep side-slopes, access through narrow easements on private lands, or confined upstream corridors (Figure 11).
- Designers should meet with contractors frequently during construction.



Figure 10: Two examples of crossing retrofits

- The online nature of crossing retrofits creates an inherent construction risk. Any construction equipment stored in the stream or floodplain will always be at risk from flood damage. Weather forecasts should be frequently consulted during in-stream work.
- Designers should carefully think about how they will work in the stream to address erosion and sediment control. Most sites will need dewatering during excavation and a method to bypass “clean” stream flows and storm runoff around the disturbed area (usually as a temporary diversion and pumping of

baseflow around the treatment cell and to the culvert).

- The secondary embankment often needs to be cast in place or formed on-site. Special construction techniques, equipment and experienced contractors are often needed.
- Crossing retrofits constructed near a road require a plan to resolve conflicts between traffic and construction equipment that ensures the safety of motorists, pedestrians, and construction workers. If regular ingress/egress to the road is needed, the highway agency may require a “maintenance of traffic” permit.
- Crossing retrofits should be inspected shortly after construction to check for clogging potential, excessive sediment deposition or changes in vegetative condition.

Crossing Retrofit Costs

Crossing retrofits tend to cost less than new retrofit ponds because they utilize free upstream storage. Their design and permitting costs, however, are often higher than other storage retrofit options. Planning level cost estimates are provided in Table 1, and site-specific factors that increase/decrease construction costs are outlined in Table 2. More detailed cost estimates will need to be developed as actual concept designs are pursued further.



Figure 11: Construction access and staging is always a challenge for crossing retrofits

Table 1: Estimated Construction Costs for Crossing Retrofits (2006 \$/ impervious acre treated)			
Retrofit Type	Median Cost	Range	Design & Engineering (%)
New Storage Retrofit ¹	\$ 19,400 ²	\$ 9,000 to \$32,000 ³	40 ⁴
¹ Use appropriate pond equation in Appendix I if retrofit site satisfies new development site conditions ² Construction costs should be reduced based on the proportion of free storage that is available above the crossing. This fraction of storage should be priced using the pond retrofit estimator ³ Adjust based on site-specific construction cost inflators/deflators in Table 2 ⁴ Increases to 45% if major environmental permits or highway agency design review is required			

Table 2: Site Specific Factors that Influence Crossing Retrofit Project Cost	
Factors that Decrease Construction Cost	Factors That Increase Construction Cost
<ul style="list-style-type: none"> • Free upstream storage (little need to excavate) • Treatment area contains no trees or wetlands • Staging areas available adjacent to floodplain • No access roads are needed to get to site • Useable compactable fill available close by • Existing roadway embankment suitable 	<ul style="list-style-type: none"> • Culvert needs to be replaced • Sewer or utility relocation • Hauling excavated materials off-site • Wetland or forest permits required • Wetland mitigation required

SR-3	Storage Retrofits	
	NEW STORAGE BELOW OUTFALLS	

This retrofit creates new treatment adjacent to the stream corridor near the terminus of an existing storm drain outfall. Outfall retrofits are designed off-line by splitting flow from the existing storm drain pipe (or ditch) and diverting it to a stormwater treatment area formed by an existing depression, excavation or constructed berm (Figure 1). A flow splitter allows larger storms to remain in the existing pipe (or ditch) and bypass the retrofit. Typical stormwater treatment options at outfall retrofits are a combination of extended detention, pond or constructed wetland storage (Figure 2). Constructed wetlands are preferred in floodplains where groundwater elevations are high and space is available. Bioretention may also work if the outfall has no dry weather flow and a small contributing drainage area (Figure 3).

- A 12 to 36 inch diameter outfall discharging above stream or floodplain
- A wide stream corridor in public ownership
- At least 150 feet of unobstructed easement over the buried pipe

Outfall retrofits are ideal because they are close to the stream and maximize the upland drainage area treated. In addition, their off-line location usually means fewer stream permitting problems. Lastly, outfall retrofits only need to be designed to provide the desired storage for water quality and/or channel protection; larger flood flows bypass the retrofit.

Ideal Conditions for Outfall Retrofits

Most communities have hundreds or even thousands of stormwater outfalls discharging to their stream network. Only a fraction of these outfalls are suitable for storage retrofits. The best outfall retrofit sites usually have:

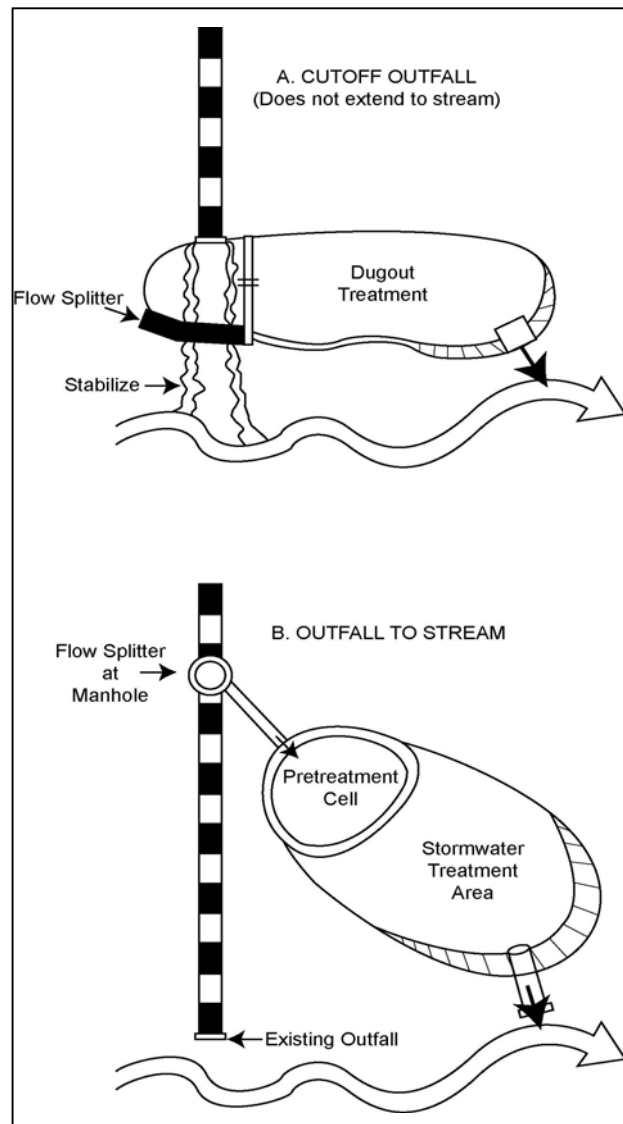

Figure 1: Two strategies for outfall retrofits in the stream corridor

- Enough pipe/channel gradient to divert flows for treatment and return them to the stream via gravity flow
- A good existing manhole to split flows and 5 to 10 feet of head to drive the retrofit
- Unutilized turf available on one or both sides of pipe
- A cutoff outfall (i.e., an outfall that discharges to the floodplain well short of the stream channel; Figure 4)

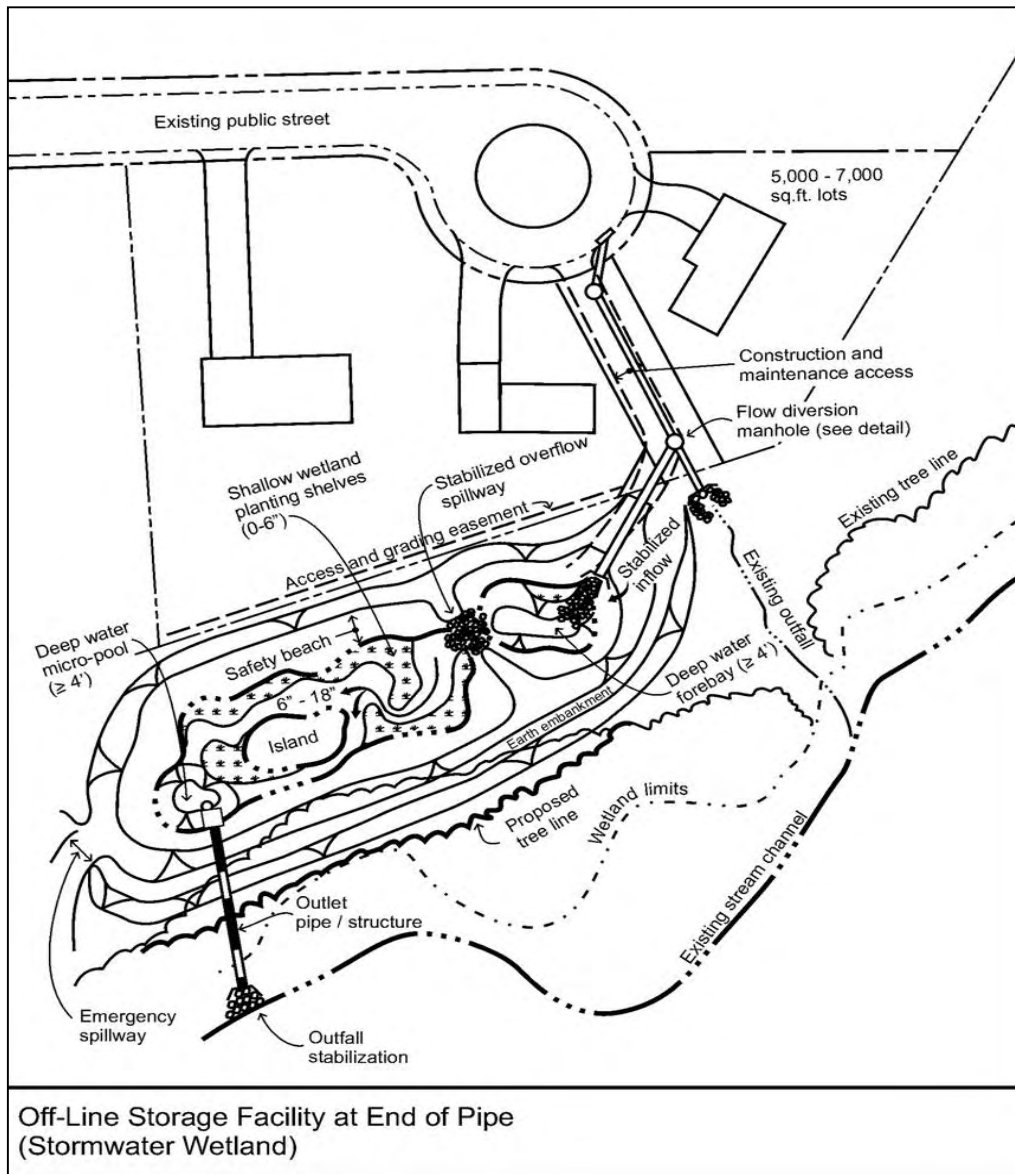

Figure 2: Splitting flow from the storm drain pipe to a constructed wetland in the stream corridor.

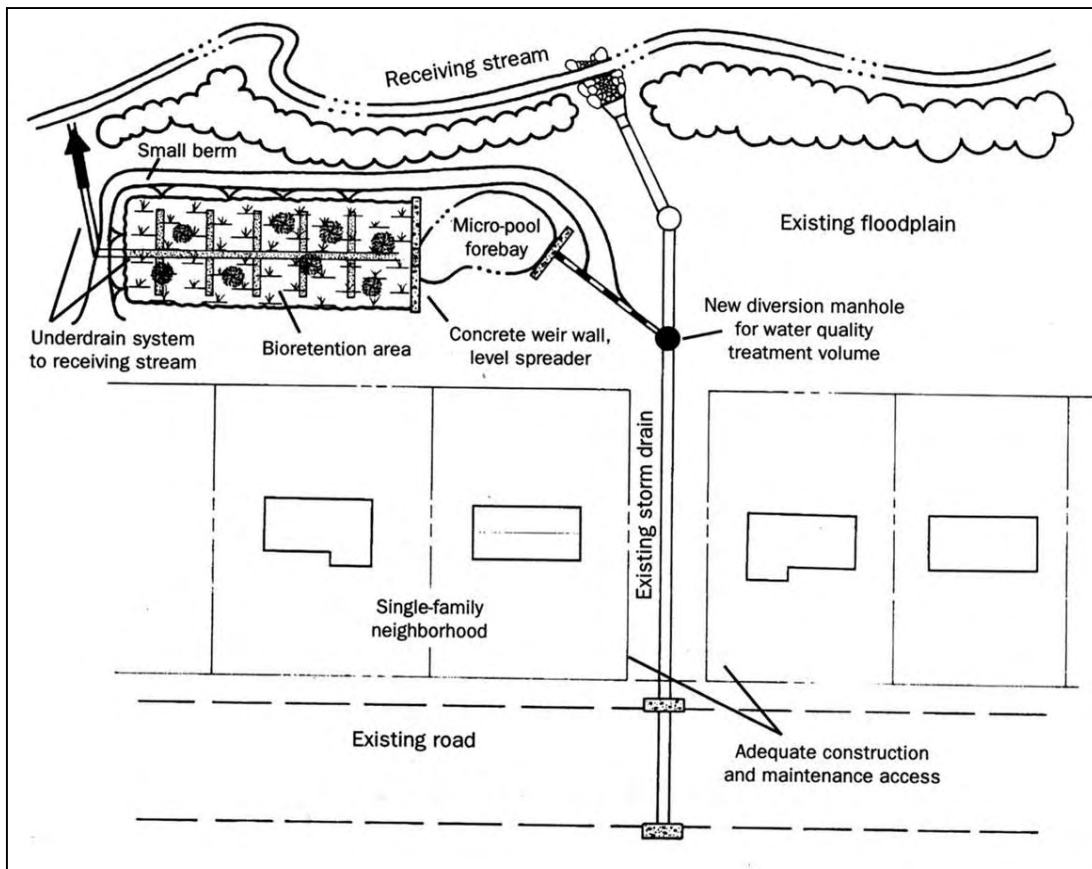

Figure 3: Schematic showing flow being split to an off-line bioretention facility.

Situations Where Outfall Retrofits are Difficult

Several factors make it difficult or impossible to get storage at an outfall, including sites where:

- Private land must be purchased
- Stream corridors are confined and lack land for surface treatment
- Stream valley parks where tree clearing would be controversial
- Very large outfalls (Pipe diameter greater than 60 inches)
- Perennial flow exists in the storm drain pipe or ditch
- Steep gradients or steep stream valley slopes limit available storage volume
- Low gradient causes unacceptable backwater conditions in the pipe system
- Outfall is subject to tidal or storm surges



Figure 4: Example of a “cutoff” outfall discharging well away from the stream

- Fill would need to be placed in the floodplain

Restoration Alternatives at Outfall Sites

Other restoration alternatives can be employed when storage retrofits are not feasible, such as:

Outfall Stabilization – Problem outfalls that exhibit excessive scour, head cutting or generate high sediment loads are a good candidate for outfall stabilization. This is common for urban streams where outfalls discharge down steep hill-slopes above stream channels and floodplain terraces (Figure 5). Outfall stabilization may include structural measures such as plunge pools, micropools and other energy dissipation practices. Eroding gullies may also be stabilized with bioengineering techniques that combine soil fill and woody vegetation together.

Stream Daylighting - This may be a good option at sites where a pipe outfalls to a



Figure 5: Reconstruction and/or bioengineering may be needed to stabilize outfalls that discharge down steep slopes.

stream and is located too far underground to split. The storm drain pipe can be removed to create a naturalized stream channel. Guidance on designing stream daylighting projects at stormwater outfalls is provided in Profile Sheet R-27 of Manual 4.

Riparian Reforestation – Tree planting is always a preferred option at open spaces in the stream corridor that lack enough room for storage retrofits.

Desktop Search for Outfall Retrofits

The best place to look for outfall retrofits is the transition zone between the upland storm drain network and the stream corridor. Within this narrow zone, there may be many opportunities to install outfall retrofits:

If a community has good GIS coverage of its storm drain and stream network, it is quite easy to superimpose both layers to find points where they coincide with open land adjacent to the stream corridor (Figure 6). If drainage features such as ditch lines are



Figure 6: Outfall retrofit sites can be discovered by overlaying storm drains, streams and adjacent open land.

available on the GIS, they should also be included in the search. The designer should search for publicly owned land parcels at least two acres in size that are associated with storm drain outfalls with a diameter greater than 12 inches and less than 36 inches. Some designers also analyze topography to get an initial estimate of the contributing drainage area to each outfall.

Stormwater outfall data may have been previously assessed during stream corridor surveys such as the Unified Stream Assessment (USA). The key USA impact forms to review include the outfall form (OT) and the impacted buffer (IB) form.

What to Look for During Outfall Investigations

The crew should first determine whether or not a flow splitter is needed to direct runoff for retrofit treatment. If so, the feasibility investigation is done in a step-wise manner, as follows:

1. Confirm the outfall diameter as it gives an indication of probable storm flows and drainage areas (Table 1). Record the shape, diameter, material and condition of the

storm drain pipe (Figure 7). Measure the rate of dry-weather flow, if present. If the flow is suspicious, conduct a discharge prevention investigation to determine if it is an illicit discharge, using the methods outlined in Brown *et al.* (2004).

2. Check out the plumbing of the storm drain system in relation to the invert of the stream channel (Figure 8). Record the approximate vertical distance between the elevation of the outfall invert, the stream bottom and the top of bank.

3. Define available treatment area on either side of the proposed split and then establish the point where split flows will enter the proposed treatment area. Use hand auger to get a sense of soil conditions and depth to water table.

4. Determine if further excavation or berms will be needed to obtain more storage in the treatment area, and estimate the probable depth of storage.

5. Look for the best place to bring treated flows back into the stream that minimizes tree loss. It may be possible to install a level spreader to discharge sheet flow across the remaining floodplain at smaller outfall retrofits.

Table 1: Guide for Estimating Drainage Area Based on Outfall Diameter			
Pipe Diameter (inches)	Discharge (cfs)	Avg Velocity (fps)	Drainage Area (est. acres)
6	1	4	0.1 to 1
12	3	6	1 to 2
24	25	10	2 to 5
36	90	12	5 to 25
48	150	14	25 to 100
60	350	18	100 to 200
Note: For pipes flowing full, with one percent slope			

6. Locate upgradient manholes that delimit the underground storm drain pipe. Manholes are installed at junctions where storm drain pipes change in size, slope, or direction. The maximum distance between manholes is usually about 200 to 400 feet. Walk off the distance of unobstructed storm drain pipe or ditch contributing to the outfall. Remember that pipe gradient does not always follow



Figure 7: Crews measure the diameter, condition and invert elevation of the storm drain outfall.

surface topography, so pop a few manholes to establish pipe depths and get a general sense of underground pipe gradient.

7. Define uppermost manhole or point along the pipe where it is possible to effectively split flows. It is desirable to have at least five to 10 feet of elevation gain from this point to the stream invert. Given standard manhole spacing, this distance may only be one to two manholes up the storm drain system.

8. Record approximate retrofit dimensions and sketch on concept plan.

Feasibility, Approvals and Permitting for Outfall Retrofits

Storage retrofits are only feasible at a limited number of outfalls within a subwatershed. Key feasibility factors include:

Head - Outfall retrofits need enough hydraulic head to drive stormwater flows by gravity from the split to the stream. Outfalls located in flat terrain or tidal areas often lack the five to 10 feet of head needed to make an outfall retrofit work, and may cause

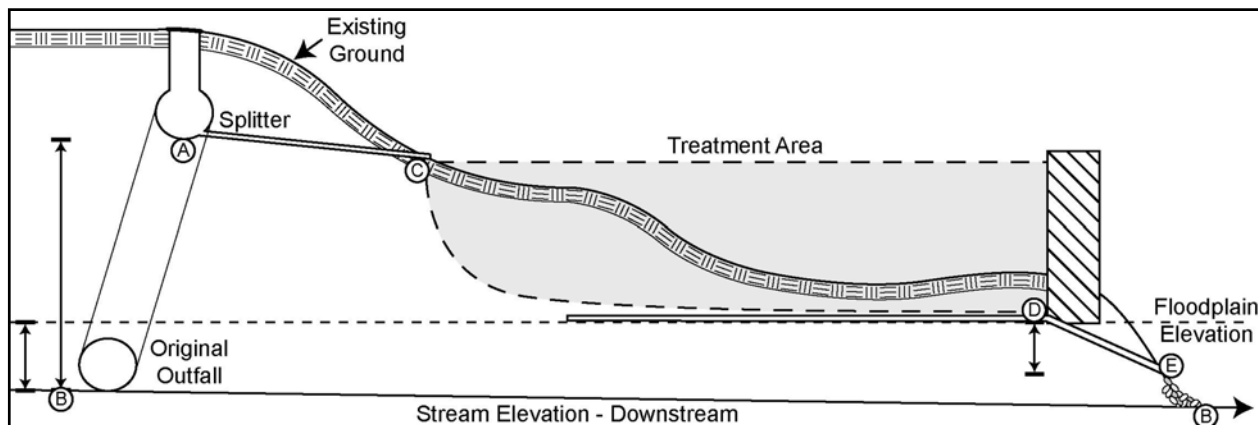

Figure 8: Design points for outfall retrofits

Several design points are of interest for outfall retrofits including (a) the location and elevation of the proposed split (b) the invert elevation of the original outfall, (c) the location and elevation of the discharge to the treatment area (d) the maximum depth of the treatment area and (e) the discharge point back to the stream. Designers need to maximize head through the retrofit, but also account for the influence of floodplain, seasonally high water table and erosive forces working on the stream bank.

tailwater and backwater problems (i.e., ponding backs water up above the split in the storm drain system, or high stream flows back water up into the treatment area).

Space – Since outfall retrofits are located in confined urban stream corridors, they are subject to severe space constraints (Figure 9). The proposed treatment area should be at least 2-5% of the contributing drainage area (depending on the proposed depth of treatment). Look carefully for surface indicators of utilities that reduce available treatment area. Sanitary sewers are a frequent problem as they often run parallel to the stream corridor. The designer should understand utility guidelines with respect to minimum sewer setbacks and the maximum permissible flood elevations to submerge manholes.

Soil Conditions at Proposed Treatment Area. The water table is often close to the surface of the floodplain, and it serves as a practical limit to the depth of excavation (and a clue that a pocket wetland may be ideal for the site). If soils appear to be hydric, designers should undertake a wetland delineation.

Outfall retrofits may require several environmental permits and landowner approvals. Since outfall retrofits are located in the stream corridor, they frequently create impacts to floodplains, wetlands and streamside forests that trigger environmental permits. If either high quality wetlands or mature forest are located within the proposed treatment area, the project should be dropped, unless there is a compelling case that existing habitats are so degraded that the proposed retrofit would restore them.

Easements for construction access or future maintenance may need to be secured at outfall sites that are effectively landlocked or have steep slopes descending to the stream corridor.

Designers should give special consideration to any changes in floodplain elevations, particularly if berms or embankments are needed to increase retrofit storage capacity. A floodplain study may be needed to determine whether any proposed floodplain fill will cause unacceptable changes in floodplain elevations. If the retrofit is located primarily within the floodplain, a



Figure 9: Field crews look for large areas of open land adjacent to the stream corridor.

dam safety permit may be required.

Designers should always model the effects of large flood events on the integrity of the retrofit. Floodplain permits are usually not a problem if the treatment storage is obtained by excavation.

Outfall retrofits are well suited for parks and other public lands. They may also be feasible on private land although designers may need to secure an expanded easement to accommodate the retrofit. In either case, the designer will need to satisfy the local park authority or landowner that the retrofit will:

- Not result in major loss of streamside forest (Figure 10). Any tree clearing should be fully reforested
- Not conflict with stream corridor uses such as footpaths, bike trails and picnic areas (ideally, the designer would incorporate these amenities into the design)
- Not create any new safety risks, particularly if the public has access to the site
- Create an attractive water feature or natural habitat area
- Utilize pondscaping, native plants and interpretive signs to educate the public
- Reduce mowing and other ongoing maintenance operations

Outfall Retrofit Design Issues

The key design element associated with outfall retrofits is the flow splitter that diverts the appropriate runoff volume into the proposed treatment area. Flow splitters use weirs or orifices to divert flows into the retrofit and bypass larger flows around it (Figure 11). The Achilles heel of splitters is clogging, so designers should always incorporate sumps and hoods within the flow splitter to protect the outlet pipe.

Designers need to be aware of backwater effects and hydraulic grade lines when sizing flow splitters to prevent unacceptable up-pipe conditions.

Another key issue involves how to discharge treated runoff back into the stream to prevent scour and erosion at the new outfall



Figure 10: Sensitive layout of outfall retrofit in a park to avoid tree clearing.

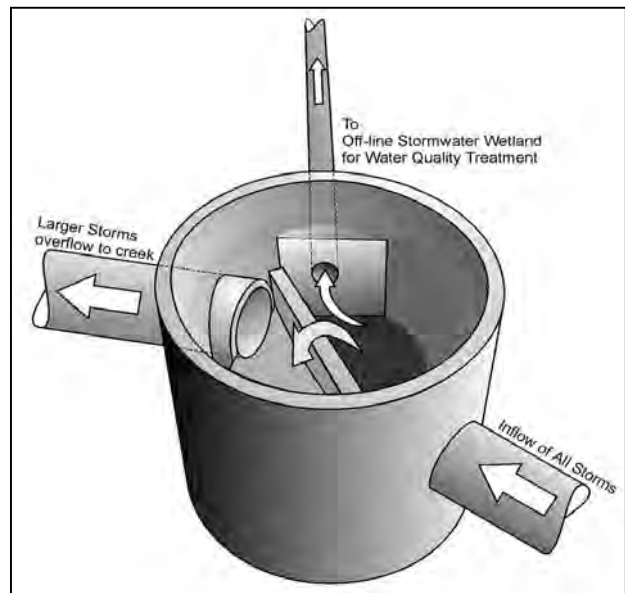

Figure 11: Detail of a flow splitter constructed in a manhole to divert flow for offline treatment.

location. This is a particular concern when there is a considerable drop to an incised urban stream with steep banks (Figure 12). Hard stream stabilization techniques are often needed to protect the new outfall from the erosive energy of the stream during bankfull floods (See Manual 4). Designers should also carefully fingerprint the outfall pipe to protect mature streamside trees and wetland features.

Designers frequently have limited space within the proposed treatment area to include design features such as forebays, benches and micropools. In general, it is better to sacrifice WQv storage than to drop these pond features. Baffles or small berms can be used to extend the flow path within the treatment area and thereby increasing residence time and enhancing pollutant removal performance.

Design Support

Several studies may be needed to support the design of outfall retrofits:

- Search for existing construction drawings of the upstream storm drain network



Figure 12: Designers may need to stabilize retrofit outfalls in incised urban streams.

- Update land cover in the contributing drainage area if it has changed over time
- Survey the invert elevations of the current storm drain system at least three manholes above the proposed split.
- Assess the condition of existing storm drain pipes
- Survey elevations within the proposed treatment area
- Take soil borings to determine depth to groundwater and excavation conditions
- Delineate wetlands and/or forest stand structure, if either is present

Design Process

The following step-wise design approach is recommended for outfall retrofits:

Step 1: Determine the target WQv storage needed at the retrofit site based on current drainage area and impervious cover to the proposed split. Conduct a rough grading analysis to determine the available storage volume (in acre-feet) within the proposed treatment area. If the target volume can be attained, proceed to the next step.

Step 2: Redo the upstream hydrology model for the existing storm drain pipe at the proposed point where flow will be split away from the pipe. Update the model input deck to account for any changes in land use, land cover, drainage divides the drainage network since the pipe system was originally designed.

Step 3: Check to see if the current pipe is flowing full or under pressure. If so, flow splitting may cause back up of flows into the upstream pipe network.

Step 4: Determine the rate and volume to divert for water quality treatment. Select an appropriate flow splitting method; several examples are shown in Figure 13.



Figure 13: Three examples of flow splitters to divert runoff for off-line treatment.

Montgomery County DEP has developed useful flow splitter design guidance which is available at

<http://permittingservices.montgomerycountymd.gov/permitting/docs/FLAWSPL.pdf>

Step 5: Conduct a backwater analysis to determine the extent of the hydraulic grade line under the appropriate design storm scenarios to ensure the practice will not result in nuisance flooding. Good design guidance has been developed by King County, Washington, and is available at <http://dnr.metrokc.gov/wlr/dss/kcbwdoc.htm>

Step 6: Route the water quality storm through the proposed treatment area, locate and size the new overflow to the stream, and verify that it will be stable under expected stream velocities.

Construction Considerations for Outfall Retrofits

The flow splitter is always a key construction consideration for outfall retrofits. Designers should always make sure they work closely with the contractor to get flow splitter elevations right, ensure joints are water tight and provide easy access for maintenance. The flow splitter should be frequently inspected after construction to ensure it functions properly and does not clog.

The advantage of a flow splitter is that it eliminates the need for a temporary diversion during construction. Storm flows continue to pass through the original storm drain pipe until the treatment area has been constructed. Once the treatment area is stabilized with vegetation, the flow splitter can be “turned on” to direct runoff for treatment.

Some in-stream work may be needed to construct a stable discharge to the stream. Designers should install appropriate in-stream erosion and sediment control practices during this phase of retrofit construction.

If the proposed site has high groundwater levels, construction logistics become very challenging. Soupy soils make excavation more difficult, and may require dewatering devices and specialized construction equipment.

Outfall Retrofit Costs

Construction costs for outfall retrofits are shown in Table 2 for various regions of the country. Table 3 outlines several site-specific factors that can increase or decrease median construction cost. Design and engineering costs for outfall retrofits tend to be higher because of additional studies needed to support the design of the flow splitter. Maintenance costs may be slightly higher at outfall sites to keep the flow splitter from clogging.

Table 2: Estimated Construction Costs for Outfall Retrofits (2006 \$/impervious acre treated)			
Retrofit Type	Median Cost	Range	Design & Engineering (%)
New Storage Retrofit ¹	\$ 19,400 ²	\$ 9,000 to \$32,000	40 ³
¹ Use appropriate pond equation in Appendix I if the retrofit site satisfies new development site conditions ² Adjust based on site-specific construction cost inflators/deflators in Table 2 ³ Increases to 45% if major environmental permits or highway agency design review is required			

Table 3: Site-specific Factors that Influence Outfall Retrofit Project Costs	
Decreases Costs	Increases Costs
<ul style="list-style-type: none"> • Simple pipe daylighting to depression • Limited off-site hauling of soil • Shallow wetland reduce excavation • Short pipe lengths into/out of treatment area • Minimal stabilization is needed at stream 	<ul style="list-style-type: none"> • Bridges needed for trails or pathways • Installing a new manhole to split flows • Existing storm drain pipe needs replacement • Utilities need relocation • High water table makes excavation soupy • Wetland or floodplain permits needed

SR-4	Storage Retrofits	
	TREATMENT IN THE CONVEYANCE SYSTEM	

This retrofit obtains storage within altered zero and first order stream channels that comprise about half of the channel network in most subwatersheds. These channels lack perennial flow, have minimal floodplains and typically have a contributing drainage area of 15 to 50 acres in humid regions. Conveyance retrofits create storage, bioretention or wetland cells in an existing ditch, swale or non-perennial stream channel (Figure 1). Conveyance retrofits are particularly appropriate in small headwater channels that have been channelized and/or hardened in the past.

There are two basic design variants for the conveyance retrofit – *in-channel* designs where stormwater treatment storage is obtained within the channel and *off-channel* designs where the treatment storage is provided in cells adjacent to the channel.

In-channel retrofits obtain storage by:

- Installing small weir walls or checkdams in the channel to provide more storage
- Converting a channel or ditch into dry swale or wet swale
- Creating a linear series of wetland or bioretention treatment cells in the channel

Off-channel retrofits split storm flows from the channel to an adjacent depression or excavated treatment area (Figure 1). Off-channel retrofits can be effective when floodplain reconnection or wetland creation

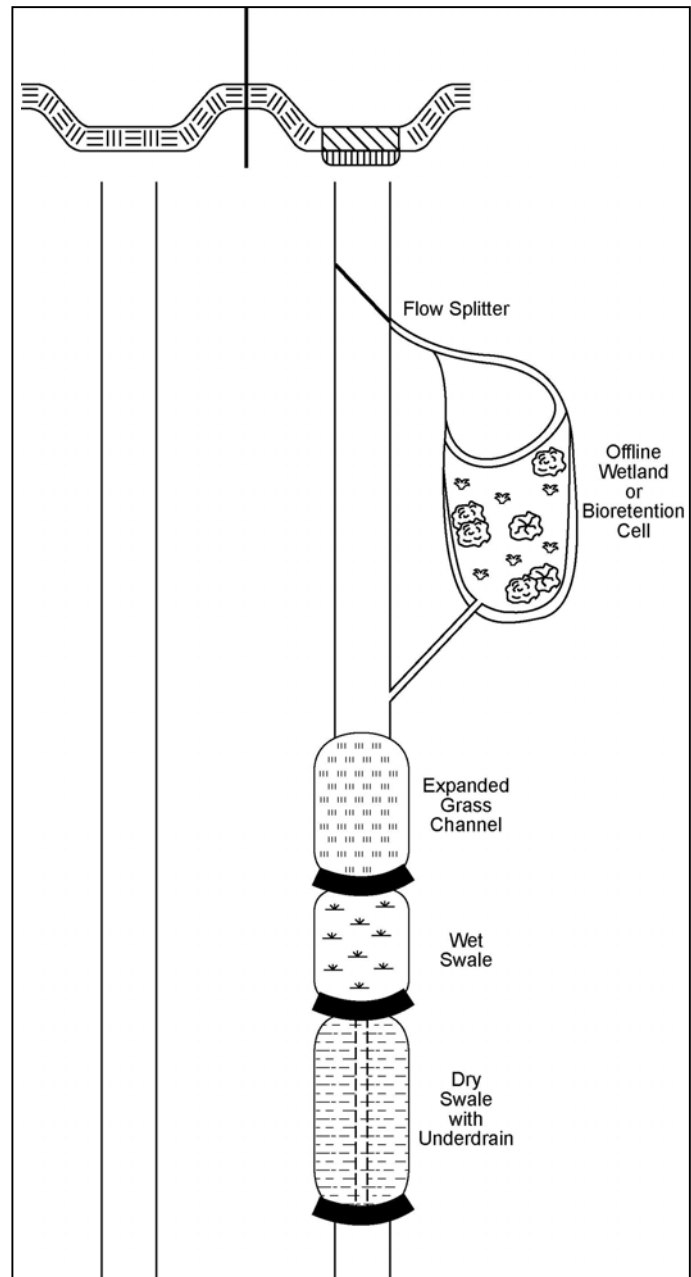

Figure 1: Both in-channel or off-channel treatment are possible in a conveyance.

is a subwatershed restoration objective. Constructed wetlands and bioretention are preferred for off-channel applications since they minimize the need for major excavation and embankments.

The stormwater conveyance system is a good location for storage retrofits since the land is usually located in a dedicated easement or right of way.

Ideal Conditions for Conveyance Retrofits

The ideal conditions for a conveyance retrofit are when the channel has:

- Gradient ranging between 0.5 and 2.0%
- Contributing drainage area of 15 to 30 acres of in humid regions with tight soils. Minimum drainage areas for conveyance retrofits are greater in arid and semi-arid regions with permeable soils.

- Been altered to promote efficient drainage (e.g., ditch, swale or concrete-lined channels; Figure 2)
- Less than three feet of elevation difference between the top of bank and the channel bottom
- Been used for roadway drainage in the right of way
- An unutilized parcel of public land located adjacent to the channel.

Figure 3 illustrates several examples of good candidate sites in the conveyance system for retrofit storage.

Situations Where Conveyance Retrofits are Difficult

Conveyance retrofits are generally not a good idea when the existing channel:

- Is in natural condition and has adjacent mature forests or wetlands
- Is rapidly degrading/incising or has a



Figure 2: Four opportunities within the conveyance system for retrofitting.



Figure 3: De-channelization and other stream repair practices are preferred when the conveyance system has perennial flow.

- knickpoint advancing upstream
- Has a channel gradient of 5% or more and/or steep side slopes
- Has perennial flow
- Is located close to a residential neighborhood
- Is privately owned or lacks a drainage easement

Restoration Alternatives for Channels

Even if a storage retrofit is not feasible, several restoration practices can still be employed in the channel:

- Natural channel design or de-channelization (Profile sheets CR-31 to CR-33 in Manual 4)
- Riparian reforestation
- Wetland restoration

Desktop Search for Conveyance Retrofits

Potential sites for conveyance retrofits are found by superimposing the stream and drainage network layers over a land ownership map. The GIS system in most communities, however, seldom shows fine drainage features such as zero-order streams and ditch lines (Figure 4). Alternatively, it may be worth looking at drainage easements

recorded on plats or entered into a local stormwater maintenance database. If local mapping is inadequate, potential sites can be found by inspecting high resolution aerial photographs or LIDAR topography (1 foot or better resolution).

If a Unified Stream Assessment (USA) has been conducted in the upper reaches of the subwatershed, potential conveyance retrofit sites can be found by examining the impacted buffer (IB) and channel modification (CM) impact forms.

What to Look for in the Field at Conveyance Sites

The field crew assesses the feasibility of a conveyance retrofit in the field by inspecting the channel reach, adjacent lands and downstream conditions.

1. Evaluate channel conditions

- Quickly estimate channel slope using a tape measure, a simple rod, or a lock-level.
- Measure the distance from the top and bottom of the channel and measure a full cross-section every 100 feet.
- Evaluate soil conditions underneath the channel using a hand auger, and record the presence of wetlands, hydric soils, standing water, erosion or perennial flow.
- Note the condition of vegetation in the existing channel and estimate the roughness of the channel and its floodplain.
- Look for signs that channel is under-capacity due to recent upstream development or past sedimentation (e.g., erosion of channel side slopes, poor vegetative stabilization, out of bank debris).

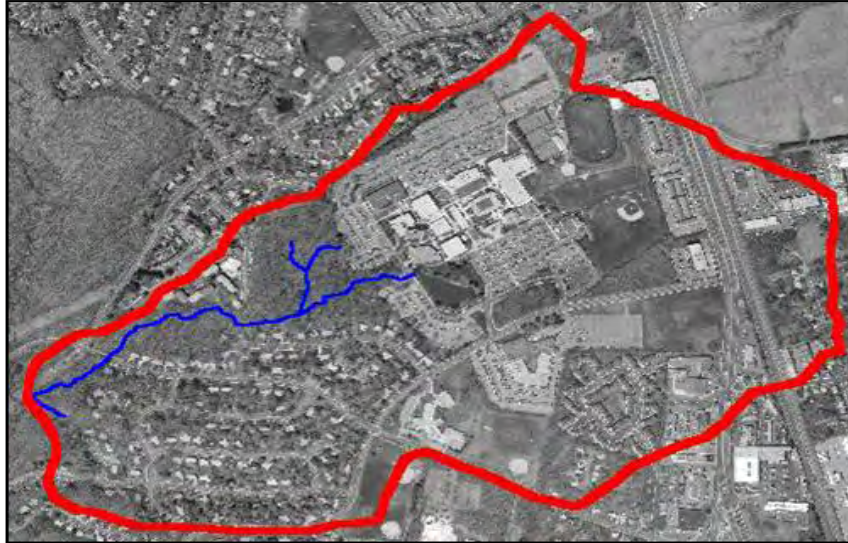

Figure 4: Most ditch lines and zero-order streams do not show up on local GIS maps.

2. Evaluate adjacent treatment potential.

The crew then looks at available land to right or left of the channel to:

- Measure the width available for treatment, such as depressed turf areas
- Look for surface indicators of underground utilities
- Find potential access points to get into the channel and places where construction equipment can be staged and stored
- Note adjacent land uses for any signs of encroachment (e.g., fencing, yard waste, dumping.)

3. Evaluate downstream conditions.

The crew then walks several hundred feet in a downstream direction to get a sense of where the channel becomes a perennial stream. The crew should look for signs of perennial flow, wetlands, and advancing knickpoints.

The site inspection helps to determine whether a conveyance retrofit is feasible and

whether it should be located in or off the channel. The crew then sketches the proposed treatment area and indicates the recommended stormwater treatment option(s) on the field sheet. The proposed treatment area may need to be adjusted back in the office based on further research on land ownership, easements and utilities.

Feasibility, Approval and Permitting for Conveyance Retrofits

Conveyance retrofits are subject to many feasibility constraints, permits and approvals. Major feasibility constraints for in-channel and off-channel conveyance retrofits include:

Narrow Easement Width - Most drainage easements are seldom wider than 20 feet and are centered on the drainage feature. As a result, conveyance retrofit sites tend to be extremely tight and linear in nature (Figure 5). Designers will often seek to secure wider easements to increase treatment area or allow construction access.



Figure 5: Not a lot of room to work with - most stormwater easements are very narrow.

Channel Capacity - Most open channels are designed to convey a certain design storm event within a given cross-section. Recent development in the contributing drainage area, however, can produce greater peak flows that exceed the channel's original capacity. If channel geometry is further modified by a conveyance retrofit, it could increase flooding risk for adjacent properties and downstream structures. Therefore, designers should maintain the required hydraulic channel capacity established by the local drainage authority, and ensure that in-channel treatment areas can withstand the erosive velocities associated with the maximum design storm.

Available Head – The gradient of the channel is important. For off-channel designs, at least three to four feet of head is needed to divert runoff from channel to the proposed treatment area and then bring it back to the channel. Similarly, several feet of head are needed for in-channel designs to filter runoff and collect it in an underdrain. Therefore, extremely low gradient channels are poor candidates for retrofits unless they are designed as wet swales. On the other

hand, steep channel gradients often preclude in-channel retrofits.

Adjacent Utilities – Drainage easements are often used as a conduit for water, sewer and other utilities. Therefore, designers should check for possible utility conflicts, particularly for off-channel designs that split flow across the channel.

Conveyance retrofits have a few unique environmental permit issues. For example, zero and first order streams occupy a curious regulatory zone. In humid regions, the regulatory 100-year floodplain only begins when the channel has picked up about 35 to 50 acres of contributing drainage area. The same stream channels lack perennial flow, so they may not be regulated under various local, state or federal environmental permits. If the proposed retrofit is in a regulated floodplain, designers will need to perform floodplain analyses to ensure it does not increase flood elevations. If wetlands and forests are present, designers should pursue the appropriate permit review.

Designers should **never** retrofit a natural channel unless it has been previously altered for drainage purposes (Figure 6). Natural zero- and first-order channels provide major watershed functions, including groundwater recharge and discharge, pollutant removal and aquatic habitat (Meyer *et al.*, 2007; Capiella and Fraley-McNeal, 2007; Schollen *et al.*, 2006). The destruction of a natural zero-order stream to install a conveyance retrofit simply exchanges one watershed function for another.

Conveyance Retrofit Design

Conveyance retrofits entail several unique design issues:

The first issue is whether to go with an in-channel or off-channel design. While this decision is dictated by site constraints, off-channel designs are generally preferred, particularly when the contributing drainage area is large. When off-channel areas are treated, designers will need to install an effective flow splitter across the channel that can handle sediment deposition and clogging by trash and woody debris. One technique for flow splitting is shown in Figure 7.

Designers also need to choose whether the channel will be primarily managed as a man-made treatment system or as a natural stream corridor feature. The choice is generally made based on the condition of the existing channel and the aesthetic preferences of adjacent landowners. Natural landscaping and bio-engineering techniques should always be considered to soften its appearance.

If designers need to expand existing stormwater easements, they will need to negotiate with multiple landowners bordering the channel. Most property



Figure 6: Three examples of natural features in zero-order streams that should not be disturbed.



Figure 7: One technique for splitting flow from the conveyance channel for off-channel treatment.

owners may grant an expanded easement if the proposed retrofit also solves an existing drainage or maintenance problem. It is also important to check to see if the easement is dedicated to the public or just to the private owner.

Designers need to calculate the erosive velocity and/or shear stress that channel soils will be exposed to over a wide range of design storms. Designers may need to reinforce the channel with geotextile fabric to prevent erosion and practice failure.

Since conveyance retrofits occur in the headwaters of the urban stream network, designers should anticipate the long term stability of the future channel. Designers should make sure the downstream end of the retrofit is protected by a fixed grade control structure to prevent an upwardly migrating knickpoint from undermining it (Figure 8). In addition, any flow splitters, weirs or checkdam installed across the existing channel should be fully armored with rock above and below the structure to prevent undercutting. The wingwalls should also extend several feet into each bank to prevent outflanking.

Since conveyance retrofits rely on vegetation for stability, designers should carefully choose grass or wetland plant species and devise a realistic plan to manage vegetation growth in future years.

Design Support

Conveyance retrofits may require several studies to support design, including:

- Legal research on drainage and stormwater easements. Few communities routinely record these in their GIS, so designers may need to analyze original development plans or even individual property deeds to confirm their boundaries
- Original design capacity computations for the existing channel
- Delineation of the contributing drainage area and land cover if either has substantially changed since the channel was originally designed
- Soil borings or test pits to determine underlying soil conditions in the channel, as well as the depth to bedrock or water table
- Surveys of current channel cross-sections and elevations and to confirm



Figure 8: Crews should look downstream for advancing knickpoints that could undermine in-channel treatments.

locations and depths of any suspected utilities.

Design Process

The design process for a conveyance retrofit depends on whether it is an in-channel or off-channel design. In both cases, hydrologic and hydraulic models are used to assess proposed water elevations with respect to channel capacity, property impacts, and potential utility submergence. The following step-wise design process is recommended for in-channel retrofits:

Step 1: Compute the desired target water quality volume for the retrofit site (in acre-feet), given its current drainage area and impervious cover. Compare this to the estimated WQv available within in-channel treatment cells. Water quality storage can be created above or below the existing channel. Storage below the channel is obtained by dry swales, bioretention swales, or excavated wetland cells, none of which alter the hydraulic capacity of the channel. Storage above the channel is obtained using weirs, berms or checkdams that do alter channel hydraulic capacity (Figure 9). If the target volume can be achieved, proceed to the next step.

Step 2: Check with the local review authority to confirm which hydraulic capacity design standards apply to (e.g., conveyance of 10-year design storm). Roadway conveyance design standards may vary based on road classification.

Step 3: Revise the existing hydrologic model for the existing open channel section (or create new one). The model input deck may need to be modified if the upstream channel or its contributing drainage area has changed since it was originally constructed. Verify that the existing channel has adequate hydraulic capacity to pass the design storm.

Step 4: Repeat the modeling process for the final retrofit channel dimensions to determine whether proposed changes in slope, channel geometry or roughness can still accommodate the local design storm for safe conveyance.

Step 5: Use Manning equation to ensure that minimum residence time is achieved for the water quality design storm within the channel treatment area. A minimum target is 10 to 20 minutes of residence time for the channel, not accounting for any infiltration into the treatment cells. Evaluate the channel geometry to ensure that flow spreads evenly over the bottom of the channel.

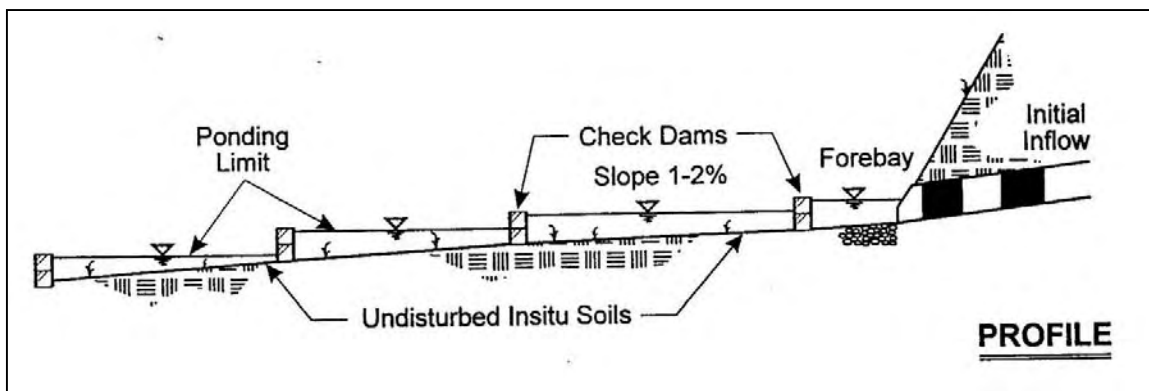

Figure 9: Getting storage on the surface of a conveyance channel using checkdams.

Step 6: Velocity control is a significant design consideration with in-channel retrofits to minimize sediment re-suspension and prevent erosion. Velocity may be reduced by further reducing channel slope, increasing the channel width, increasing roughness, or using geotextile reinforcement. Scour analysis may be needed to size the diameter of stone needed to stabilize checkdams, biologs or weir walls.

Step 7: Employ a grade control to fix the downstream elevation of the retrofit in larger naturalized channels. A rock vortex weir may be appropriate to fix the retrofit (See Profile Sheets R-18 to R-21 in Manual 4). An entrenched stone checkdam should suffice for smaller conveyance channels. The design process for off-channel retrofits is very similar to outfall retrofits (See Profile Sheet SR-3). Several examples of conveyance retrofits are presented in Figure 10.

Construction Considerations for Conveyance Retrofits

Conveyance retrofits can be challenging to construct for several reasons. Construction access and staging areas are always at a premium given that most drainage easements are very narrow (10 to 50 feet). Designers often need to get temporary easements to store construction equipment and materials (Figure 11). Bid documents should specify specialized construction equipment that can work in tight and narrow spaces (such as bobcats).

Even though most conveyance retrofits lack perennial flow, designers should consider the effect of storm flow when it comes to erosion and sediment control. In particular, erosion control fabrics are recommended to anchor the bottom of the channel (see Profile Sheet R-10 in Manual 4). Sod may be needed to anchor steeper channel side-slopes.

Designers will need to find a way to bypass or pump around storm flows during retrofit construction. The construction schedule should be compressed to complete work as soon as possible and rapidly stabilize the channel so the retrofit is not washed out by an early storm. Contractors should consult weather forecasts before commencing work, and contingency items should be included in contracts to allow for replacement of plant material and temporary channel repairs.

Conveyance Retrofit Costs

A planning level cost for conveyance retrofits can be developed based on the stormwater treatment options employed (Table 1). In general, off-channel designs are more costly than in-channel designs due to the need to construct a flow splitter. Construction costs for conveyance retrofits are extremely variable, and designers should always look at site-specific factors shown in Table 2 to adjust their final cost estimate.



Figure 10: Four examples of conveyance retrofits.



Figure 11: Specialized equipment is needed to work within tight project boundaries.

Table 1: Estimated Construction Costs for Conveyance Retrofits (2006 \$ per impervious acre treated)			
Retrofit Type	Median Cost³	Range	Design & Engineering (%)⁴
In-channel treatment ¹	\$ 45,400	\$ 25,400 to \$62,600	32
Off-channel treatment ²	\$ 68,100	\$38,100 to \$93,900	32

¹ Based on average cost for water quality retrofit which may be high if the existing channel requires little surface grading
² Costs for off-channel treatment assumed to be 1.5 times more expensive due to need for flow splitters and channel reconnections
³ Adjust the median cost to account for site-specific construction cost inflators/deflators shown in Table 2
⁴ May increase to 40% if zero order streams are regulated under section 404 or if deed research is needed for multiple landowners

Table 2: Site-specific Factors that Influence Conveyance Retrofit Construction Cost	
Factors that Decrease Costs	Factors That Increase Cost
<ul style="list-style-type: none"> • Wide drainage easement available • Public land available for off-channel treatment • Existing channel is over-capacity • Single property owner • Ability to construct with small equipment • Surface treatment in swale (wet swales) 	<ul style="list-style-type: none"> • Need to negotiate additional access easements • Poor construction access • Wetland permitting • Legal research on easements • Multiple property owners to notify • Flow splitter needed

SR-5	Storage Retrofits	
	STORAGE IN TRANSPORT RIGHTS-OF-WAY	

Highways contain un-used land within their right-of-way where storage can be obtained by diverting highway runoff into a depression or excavated area. Highways frequently cross local drainage divides, which reduces contributing drainage area and makes the corresponding WQv storage more manageable. In most cases the contributing drainage area to a highway retrofit is less than 10 acres.

The most common stormwater treatment options for highway retrofits are ponds and constructed wetlands, although linear bioretention and swales may also be feasible in wider medians and rights-of-way (Figure 1). In general, infiltration is not recommended as a stormwater treatment option, unless they contain enough pretreatment to fully capture and contain a 10,000 gallon spill.

Highway retrofits are ideal because their runoff pollutant concentration is high. Land costs are negligible since the retrofit is located in the dedicated right of way. Highway agencies have stronger incentives to retrofit to comply with emerging stormwater permit requirements, watershed mitigation needs and hazardous material spill liability. Lastly, highway agencies are often “good maintainers” and may see retrofits as a means of reducing their ongoing maintenance operations.

Ideal Conditions for Highway Retrofits

The best conditions to shoehorn storage retrofits into the highway system occur at:

- Cloverleaf interchanges (Figure 2)
- Depressions created by approach ramps
- Open section drainage within a right-of-way that is wider than 30 feet and located down-gradient from the road and free of utilities
- Drainage leading to bridges that cross streams with extensive floodplains
- Highway drainage that can be diverted to adjacent public land
- Targets of opportunity in highway widening/realignment construction projects

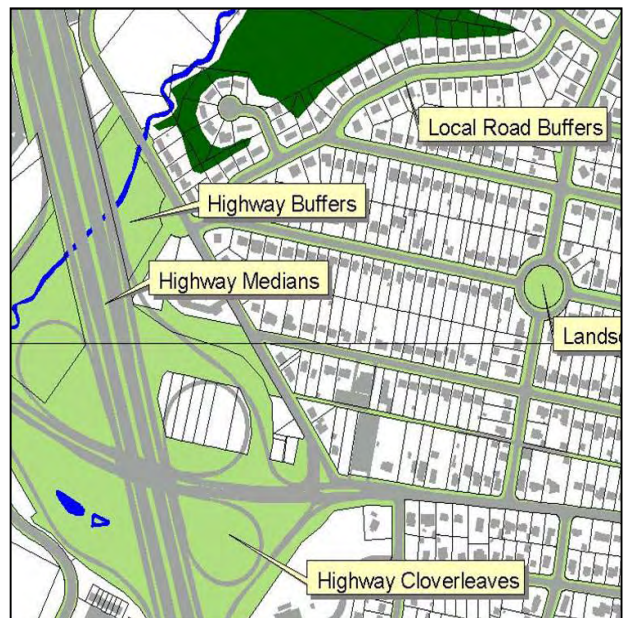

Figure 1: Highway corridors present numerous retrofitting opportunities.

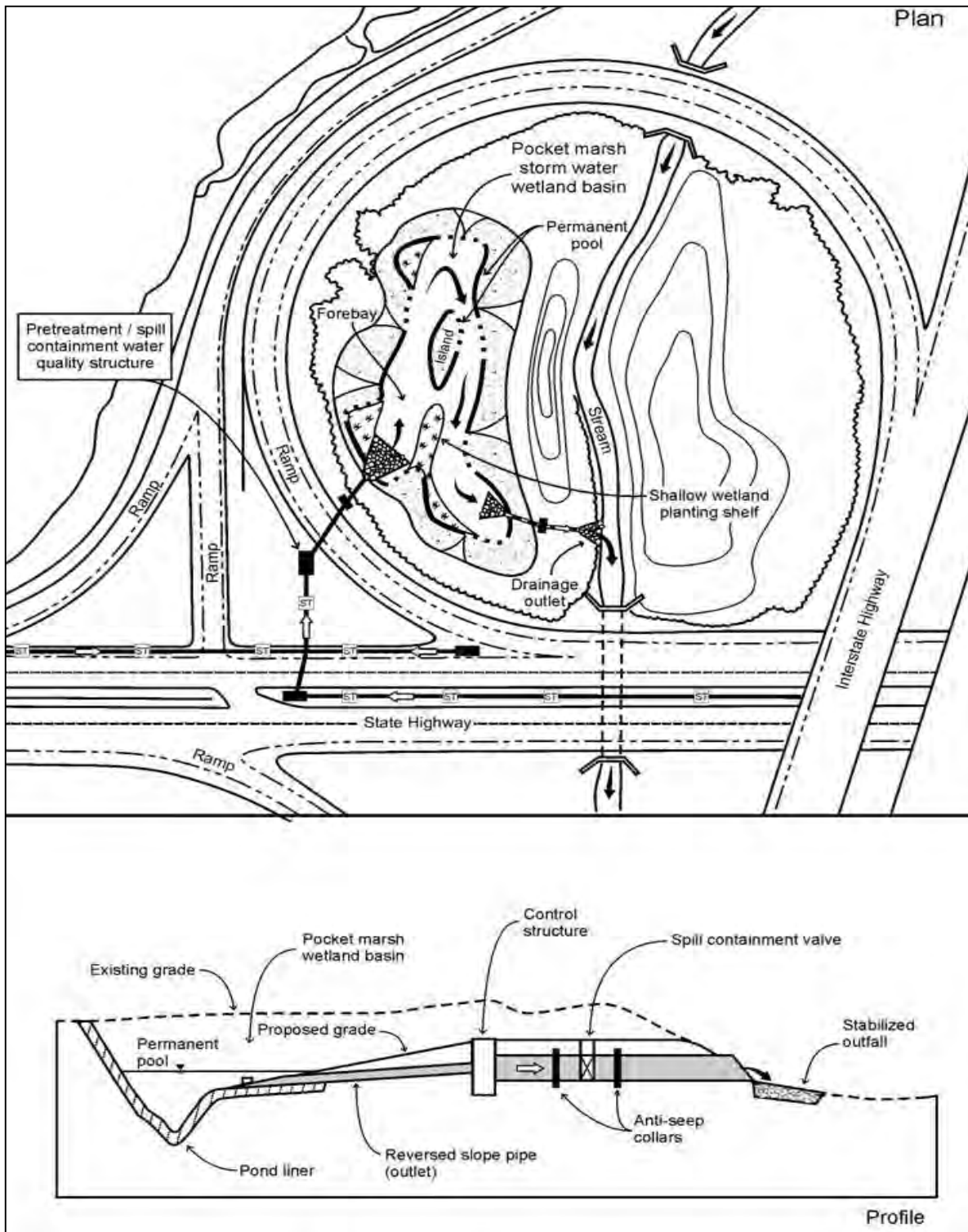

Figure 2: Plan and profile of wetland retrofit within cloverleaf interchange.

Situations Where Highway Retrofits are Difficult

Retrofitting is not a good idea at highway sites that:

- Are likely to be widened or expanded in the future to handle increased traffic flow
- Have guard rails, steep side-slopes or limited sight distance
- Require lane closures to provide construction or maintenance access
- Are slated to be used as a staging area for future road construction projects

Restoration Alternatives at Highway Sites

If a storage retrofit is not feasible, the site may still be suitable for reforestation (Figure 3) using the highway tree planting methods outlined in Cappiella *et al.* (2006a).

Desktop Search for Highway Retrofits

Potential highway retrofit sites can be found using several methods. The quickest is to visually examine aerial photos, since major highway features tend to really stand out (Figure 4). A more systematic method is search existing local, state or federal highway right-of-way GIS layers against open land and the stream network. The combined land area in open space and right of way should generally meet a minimum acreage threshold of one acre. Most highway agencies have good maps of their road drainage, so try to get copies to take into the field (Figure 5). These maps should be analyzed to find any existing highway stormwater treatment practices that might be suitable for retrofitting.



Figure 3: Reforestation may be a viable option if a retrofit is not feasible.



Figure 4: Highway retrofits really stand out in aerial photos, although highway drainage does not.



Figure 5: Many highway agencies have good GIS data on their stormwater infrastructure.

Highway drainage maps are a great help since highways often define (and frequently alter) the topographic boundaries of the contributing drainage area. Some designers may want to analyze these maps to initially estimate drainage area to potential highway retrofit sites before they go out in the field. Designers should also coordinate with highway planners about future road construction plans that could influence proposed retrofit sites. For example, an otherwise fine treatment area might be slated for construction staging in a future road construction project.

What to Look for During Field Investigations at Highway Retrofits

Highway retrofit sites can be dangerous, so safety is paramount. Crews should wear blaze orange safety vests, don hardhats, and look for safe places to park vehicles and cross traffic lanes to access the site. Crews should always get authorization from the highway agency to access potential retrofit sites. Better yet, highway engineers should be invited to share their knowledge about road safety, drainage and history. It is advisable to get highway drainage maps

before going out in the field, since highway drainage can be complex and confusing to determine in the field. As a general rule, sites that are hazardous to access will be poor retrofit candidates. Assuming a site is reasonably safe, the crew should:

Check to see whether the highway has open or closed drainage and try to delimit the upstream drainage divide. The actual drainage can be difficult to ascertain because of subtle grades, or pipes that buck grade, so the crew may need to consult as-built drawings to solve the drainage puzzle.

Sketch out the contributing drainage area and flow path and compare against highway design drawings. Most highway retrofits have fairly small drainage areas, so several retrofits may be needed for full treatment. As a rule, keep in mind that each 100 feet of a 10 foot travel lane equates to about 0.022 acres of drainage area. Look for obvious depressions in a down gradient direction that can provide treatment without major excavation.

Remember that available treatment area needs to be adjusted to account for standard highway safety setbacks. For example, a 15 to 50 foot setback from edge of pavement is normally required for sight distance and traffic safety. Similarly, many highway agencies insist that road side-slopes be maintained at a grade of 6:1 (h:v) or better in the absence of guard rails.

The crew should measure available head, which is usually fixed by the invert of the receiving highway drainage system. In most cases, at least six feet of head is needed to drive pond or wetland retrofits.

Feasibility, Approvals and Permitting for Highway Retrofits

The greatest hurdle is getting approval from the local/state or federal highway agency that owns the retrofit site.

Early coordination with the appropriate highway agency is essential. Designers should thoroughly understand all agency road design requirements such as setbacks from pavement, sight lines, pool depths, minimum freeboard, access and drainage capacity, and treat them as a given during retrofit assessment and design. The highway agency will want to ensure that the proposed design will not saturate existing roadway embankments nor diminish the flow capacity of existing highway drainage.

In most cases, retrofit construction will temporarily interrupt traffic flow, so the reviewing agency will want to know how traffic flow will be maintained, and may require a separate permit known as a “maintenance of traffic” plan.

Highway agencies are keenly interested in the maintenance implications of the retrofit and who will pay for it. The highway agency maintaining the right-of-way will normally maintain the new retrofit, and will expect that safe access and spill control be addressed. The approving agency will expect a written maintenance agreement that clearly defines the duties, schedules and contingencies for future maintenance operations. The reviewing agency will want assurances that the proposed retrofit will not interfere with routine highway maintenance operations such as pulling ditches or mowing.

Most highway retrofits do not involve environmental permits, although it is good practice to minimize any major tree loss or

wetland impact. In some regions, the wetland permitting authority may regulate wetlands that were unintentionally created by original highway construction, so be sure to consult them about their jurisdictional status. Highway agencies usually have numerous wetland mitigation needs, so designers may want to utilize constructed wetlands as the stormwater treatment option to make the retrofit more attractive.

If trees are cleared during construction that remove an existing visual screen or noise barrier, expect significant concerns from adjacent residents about the loss of trees.

Design of Highway Retrofits

Highway retrofits involve several unique design considerations, including:

Road design criteria - Designers need to fully understand and satisfy all highway design criteria relating to safety and maintenance to have any chance of getting the retrofit approved by the review agency. For example, most agencies will require a minimum 30 foot “clear zone” from the road shoulder to allow vehicles to recover when they run off the road.

Design for higher pollutant loadings - Highway runoff can be a significant source for sediment, hydrocarbons, heavy metals and other pollutants, so designers should select the best stormwater treatment option that maximize removal of the pollutant of concern. Highway runoff also contains high inputs of litter and debris that can cause clogging, reduce treatment capacity and increase retrofit maintenance burdens.

Pretreatment - Over-sized pretreatment is recommended for most highway retrofits. The pretreatment cell should comprise at least 25% of the entire WQv storage.

Safe and direct maintenance access -

Highway agencies will always insist on safe and direct access for heavy equipment to the retrofit. Operationally, this means a retrofit design that avoids steep slopes, reduces the need for lane closures, allows for safe highway ingress/egress and enables vehicles to turnaround easily.

Compatibility with ongoing highway maintenance -

Highway crews need to efficiently maintain hundreds of miles of ditch, shoulder and right of way every year. Designers should consult them to determine how the proposed retrofit will influence their routine maintenance operations, and be prepared to adjust the design accordingly.

Maintenance of traffic - Temporary lane closures are often needed at critical points in retrofit construction to ensure the safety of both construction workers and motorists. A detailed construction sequence must be formulated to safely segregate traffic and construction equipment. The retrofit maintenance plan should also specify how traffic will be managed to permit maintenance access.

Wintertime operation - Designers in northern climates should always consider how snow management will impact the proposed retrofit. For example, high chloride inputs can harm vegetation, so landscaping plans should specify salt tolerant plant species. If road sanding loads are high, designers should incorporate additional storage and/or pretreatment. Lastly, designers should anticipate the direct impact of snow plowing, dumping and melting on the retrofit and its vegetation, as well as the risk of damage to inlets and curbs from snow plows.

Spill Containment - Accidents and spills are a common occurrence along highways, so it

is wise to incorporate spill containment features into highway retrofits. Ponds, wetlands and pretreatment cells should contain a butterfly shut-off valve so that spills can be rapidly contained within the retrofit. If underlying soils are permeable, it may be advisable to install liners to prevent downward migration of polluted stormwater. Figure 6 shows a large surface sand filter in Austin, Texas that has a hazardous material diversion chamber located prior to the filtering treatment area.

Sediment Disposal - Sediments that accumulate in highway retrofits have a small but higher risk of being classified as hazardous waste due to stormwater runoff and spills. Visual inspections are recommended prior to sediment removal operations to determine if further testing is needed. If the visual inspection indicates sediments are discolored or malodorous, sediment testing can determine whether they need to be disposed in a conventional landfill or special hazardous waste facility.



Figure 6: Spill containment should be a feature in highway retrofit designs.

Design Support

Highway retrofits require several special studies to support design, including:

- Interview highway planners about future uses at the proposed site.
- Review as-built surveys to delineate the contributing drainage area and drainage network. If these are not available, surveys may be needed to confirm drainage areas and elevations.
- Take soil borings at the proposed treatment area since the original soils have been severely altered and compacted by mass grading during initial road construction.
- If the proposed retrofit is located close to the right-of-way boundary, conduct plat research to define ownership and establish easements.

Design Process

The highway review agency will dictate the design process for each retrofit site. The design process will also depend heavily on the type of stormwater treatment selected (Figure 7).

Construction Considerations for Highway Retrofits

Construction of highway retrofits are challenging given the volume and speed of nearby traffic.

- Contractors should diligently follow the maintenance of traffic plan to ensure worker and motorist safety.
- Highway retrofits tend to be quite tight for material and equipment staging.
- Erosion and sediment controls should be scrupulously maintained since these retrofits are visible to passing motorists

Highway Retrofit Costs

Cost data are fairly sparse for highway retrofits. For planning purposes, construction costs can be assumed to be equivalent to the cost to construct a new retrofit facility, as shown in Table 1. Construction cost estimates should be adjusted to account for site-specific factors that can influence highway retrofit construction, as shown in Table 2.



Figure 7: Two examples of retrofits located in the highway right of way.

Table 1: Estimated Construction Costs for Highway Retrofits (2006 \$ per impervious acre treated)			
Retrofit Type	Median Cost	Range ²	Design & Engineering
New storage retrofit ¹	\$19,400	\$9,000 to \$32,000	32% ³
¹ Use appropriate pond equation in Appendix I if retrofit site satisfies new development site conditions ² Adjust based on site-specific construction cost inflators/deflators in Table 2 ³ Increases to 40% if extensive highway agency design review approval is needed			

Table 2: Site Specific Factors that Influence Highway Retrofit Projects	
Factors that increase costs	Factors that decrease costs
<ul style="list-style-type: none"> • Need to excavate to get storage • Off-site hauling • Need new maintenance access • Gates and fencing • Erection of temporary construction barrier • Spill controls 	<ul style="list-style-type: none"> • Existing depression • Open section roads • Gentle side slopes • Low traffic volumes • Cooperative highway review agency • Retrofit contributes to mitigation needs

SR-6	Storage Retrofits	
	LARGE PARKING LOT RETROFITS	

Large parking lots are a good retrofit opportunity to treat runoff quality. Large parking lots are defined as five acres or greater in size (including any connected rooftops – Figure 1). Common examples include lots serving municipal buildings, high schools, regional shopping malls, stadiums, auto dealerships, airports, commuter lots, hospitals and big box retail stores. Larger parking lots are normally served by extensive storm drain systems and contain numerous inlets, underground pipes and outfalls.

This retrofit strategy excavates centralized treatment storage in unutilized land located downgradient of the lot (Figure 2). Common stormwater treatment options include extended detention, ponds, constructed wetlands or a large bioretention area.



Figure 1: Large parking lots are a key retrofit target.

Centralized retrofits are not the only retrofit strategy for parking lots; an on-site retrofit strategy for small parking lots is described in Profile Sheets OS-8 and OS-13. The centralized retrofit strategy is generally more cost-effective on a per acre treated basis than an on-site strategy.

Large parking lots are an ideal retrofit because they generate more stormwater runoff and pollutants on a unit area basis than any other land use in a subwatershed.

Ideal Conditions for Parking Lot Retrofits

Parking lots built in the last few decades are good retrofit opportunities since local codes often require more generous setbacks for screening, landscaping and noise reduction. Recently developed suburban commercial zones are only about 70% impervious, suggesting that a decent fraction of the site may be available for surface treatment (Cappiella and Brown, 2001). Other good retrofit situations are:

- Parking lots serving large institutions, corporate campuses and colleges that tend to have even lower percentage of impervious cover for the whole site.
- Municipally-owned parking lots such as commuter lots, park access, and schools adjacent to open areas
- Industrial parking lots designated as stormwater hotspots
- Any parking lot served by an existing stormwater detention pond (use SR-1)



Figure 2: Down gradient open land reserved in setbacks is ideal for treatment.

Situations Where Parking Lot Retrofits Are Difficult

Several conditions make it difficult to retrofit a large parking lot:

- Parking lot is smaller than five acres in size (but try on-site parking lot retrofits described in Profile Sheet OS-8)
- Older lots located in highly urban areas, such as downtown central business districts
- Parking lots that discharge directly to waterfronts or waterways
- Open space adjacent to the parking lot is designated as a jurisdictional wetland, stream buffer or forest reserve.

Restoration Alternatives at Large Parking Lots

Even if a storage retrofit is not feasible, it may still be possible to install other restoration practices inside the parking lot or along its margins, such as:

Reforestation - in open spaces, parking lot islands and setbacks using the planting methods outlined in Cappiella *et al.* (2006a).

Pollution prevention practices - particularly when the lot is used for vehicle storage or is frequently resealed (see Profile Sheets H-4 and H-11 in Manual 8).

Regular vacuum sweeping and litter control - to keep gross solids and trash from entering the storm drain system.

Desktop Searching for Parking Lot Retrofits

It is fairly easy to find large parking lots since they stand out on aerial photographs or recent land use maps (Figure 3).

Alternatively, a GIS search can match large contiguous parking areas/rooftops greater than 5 acres in size with adjacent open land in public or institutional ownerships. Some topographic analysis may be useful to confirm that the open land is actually downgradient from the lot.

The contributing drainage area is defined as the sum of the lot area and the footprint of the buildings it serves. It is helpful to estimate the contributing drainage area before investigating the lot in the field.



Figure 3: Large parking lots and potential off-site treatment area are easy to find on aerial photos.

What to Look for When Investigating Parking Lot Retrofits

The retrofit recon for a large parking lot is fairly straightforward, and is best done when parking demand is lowest (e.g., weekends, daytime or evening, depending on the use), and while it is raining.

1. *Confirm the size and use of the parking lot* - The crew should walk the entire lot to get a sense of its total area and whether it is connected to rooftop drainage. A simple rule of thumb is that 400 square feet of impervious cover are associated with each individual parking stall (Schueler, 1994) so that one acre of impervious cover is created for every 100 parking spaces (rooftop drainage not included). The crew can get a good sense of the acreage of the parking lot by quickly estimating the number of parking spaces in the lot, and multiplying it by 400 (Figure 4).

2. *Assess parking lot grade* - While most parking lots seem to be flat, they have subtle grading to key curb or drop inlets. If stormwater plans exist for the lot, they should be taken out in the field. The crew should sketch the existing plumbing by tracing the storm drain inlets toward the low

point of site and looking for obvious points of discharge into adjacent open space (Figure 5). The crew should look for additional stormwater outfalls and pull a manhole or two to see how deep the pipes are underground. The crew may also want to see if there are good locations to cut the curb to divert surface runoff to a treatment area.

3. *Estimate the boundaries of the treatment area* - The crew should pace the approximate boundaries of the proposed treatment area, taking care to look for surface indicators of underground utilities that may reduce it. The size of the proposed treatment area can then be compared to the contributing drainage area estimated in Step 1. As a general rule, the proposed treatment area needs to be at least 3 to 5% of the contributing drainage area. Alternatively, the crew can directly compute the target WQv using the 3600 cubic feet per impervious acre rule, assuming that the contributing drainage area is 100% impervious.

4. *Evaluate head* - The crew then visually estimates the elevation difference between the invert of the storm drain outfall from the parking lot and the elevation at the proposed treatment area. Like most other storage retrofits, hydraulic head is needed to accommodate the depth of treatment and drive the retrofit by gravity flow. A

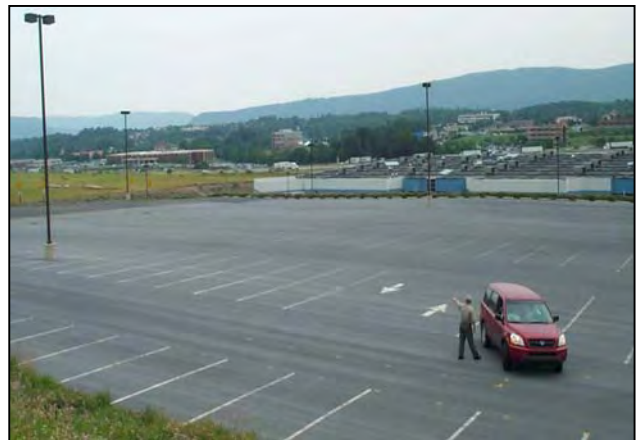

Figure 4: Stall counting is a quick way to estimate parking lot area.



Figure 5: The crew should check out the internal plumbing of the lot to see where runoff goes.

minimum of four to six feet of head is needed to make storage retrofits feasible at most parking lots (Figure 6). The crew may want to inspect soil conditions in the proposed treatment area using a soil auger to determine how deeply the retrofit could be excavated.

5. Sketch out the proposed design - Based on the foregoing information, the crew should have a good sense of the best stormwater treatment option for the site and whether a flow splitter is needed to direct stormwater into the proposed treatment area. The preliminary concept should then be sketched on the RRI field form.

6. Consider on-site parking lot options. If the recon indicates a storage retrofit cannot work, the crew should break up the lot into smaller drainage units to determine if some or all of it can be served by on-site retrofits located within the lot or along its margins (see Profile Sheet OS-8).

Feasibility, Approvals and Permitting for Large Parking Lot Retrofits

The biggest hurdle is getting permission to retrofit the open space parcel without having to acquire the land. The problem is pronounced when the adjacent land is not owned by the same landowner. Just because a parcel is open today doesn't mean that it is not slated for future development. Some initial research is needed to determine the development status of the open parcel. The best situation is when the parcel cannot be developed because it is contained within a required easement, open space, or setback.

Underground utilities are another common hurdle for parking lot retrofits. Sewer, water, gas and other utilities can be challenging obstacles to design around or relocate. Above-ground lighting, signs and overhead wires can also be a problem, but are somewhat easier and cheaper to relocate. If the parking lot outfall discharges to a floodplain or stream corridor, designers should check to see if the flows will impact wetlands, floodplains or forests.



Figure 6: The invert elevation of the storm drain pipe underneath the lot is a critical design factors.

Parking Lot Retrofit Design

The basic design of parking lot retrofits is fairly standard, but there are a few issues worth noting:

Designers may need to install flow splitters within the parking lot to divert runoff from the storm drain pipe to a more desirable area for water quality treatment (see Profile Sheet SR-3)

Large parking lots generate a lot of trash, litter and debris and can have high sediment loadings due to winter sand applications. Consequently, designers should provide over-sized and accessible pretreatment (e.g., forebays) and plan on a more frequent sediment removal schedule (Figure 7).

Designers should consult with the facility manager to gain a better understanding of temporary or seasonal parking lot maintenance practices that can influence retrofit design, such as deicing applications, snow storage, sweeping, and vehicle washing (Figure 8). Designers should landscape the



Figure 8: Designers should check to see if the proposed treatment area can be used for winter snow storage.

retrofit to improve its appearance, particularly when it is located in a highly visible area.

Design Support

Design support for parking lot retrofits may include several tasks:

- Secure as-built drawings of the original parking lot design from the local review authority. If they are not available, drainage area may need to be re-delineated and surveyors may need to take spot elevations of parking lot plumbing.
- Research zoning, easement and plat records to determine the future development potential of the proposed treatment area
- Take standard soil test pits in the proposed treatment area
- Conduct parking demand studies to confirm that the existing lot has enough capacity to meet current and reasonable future parking needs
- Delineate any forests or wetlands that may be present in the proposed treatment area (or any other wetlands or forests



Figure 7: While ponds are most common, larger bioretention areas can provide effective treatment.

Note: a two-cell design with forebay would have worked better for this site

that may receive stormwater discharges from the new retrofit).

Design Process

The basic design process for large parking lot retrofits is essentially the same as a new stormwater facility, unless flow splitters or curb cuts are used to divert stormwater runoff to an off-line treatment area.

Construction Considerations for Parking Lot Retrofits

Large parking lot retrofits involve the same basic construction sequence as new stormwater ponds, although a few logistical issues arise if the lot is being actively used:

A small portion of the lot may need to be closed for construction access, staging and

storage. Both construction and staging areas should be temporarily fenced to keep the public out. Traffic management plans may be needed to segregate construction ingress and egress traffic from existing motorists. Construction should be scheduled to avoid obvious spikes in parking demand such as the holiday shopping season.

Parking Lot Retrofit Costs

The cost to construct parking lot retrofits is generally assumed to be equal to the cost to construct a new retrofit facility (Table 1). Cost equations for specific stormwater treatment options may also be used to get a more accurate estimate (See Appendix J). The cost estimate should be adjusted to account for numerous site-specific factors that can influence retrofit construction costs shown in Table 2.

Table 1: Estimated Construction Costs for Large Parking Lot Retrofits (2006 \$ per acre of impervious cover treated)			
Retrofit Type	Median Cost	Range ²	Design & Engineering (%)
New storage retrofit ¹	\$19,400	\$9,000 to \$32,000	32
¹ Use appropriate pond equation in Appendix I if the retrofit site satisfies new development site conditions			
² Adjust based on site-specific construction cost inflators/deflators in Table 2			

Table 2: Site-specific Factors that Influence Large Parking Lot Retrofit Project Costs	
Factors that Decrease Cost	Factors that Increase Cost
<ul style="list-style-type: none"> • Public land or cooperative landowner • Storage via embankment rather than excavation • Off-line design • Existing storm drain discharges near surface • Use of ED wetland as treatment option • No environmental permits needed • Staging and stockpiling areas away from lot 	<ul style="list-style-type: none"> • Off-site hauling • Need to secure stormwater easements • Pavement repair due to construction equipment • Reworking the storm drain system underneath the parking lot • Relocating downstream storm drain or channel • Flow splitting • Land acquisition

OS-7	On-site Retrofits	
	HOTSPOT OPERATIONS	

These retrofits provide on-site water quality treatment at confirmed stormwater hotspots, defined as any operation that generates higher concentrations of stormwater pollutants and/or has a higher risk of spills, leaks or illicit discharges. Pollution prevention practices such as covering, secondary containment, and employee training should always be considered first. However, when prevention practices are not sufficient to provide full treatment, on-site retrofits are needed to treat the quality of runoff from the stormwater hotspot (Figure 1).

Alternatively, bioretention without exfiltration may be used (Profile Sheet ST-4). The use of infiltration is strongly discouraged due to the risk of groundwater contamination.

Hotspots are good locations for on-site retrofits since they contribute higher stormwater pollutant loads than any other urban source area. Second, many communities have the regulatory authority to compel private landowners to install onsite retrofits to comply with municipal or industrial stormwater requirements.

The preferred stormwater treatment option at hotspot operations are filtering practices (Figure 2 and Profile Sheet ST-5).

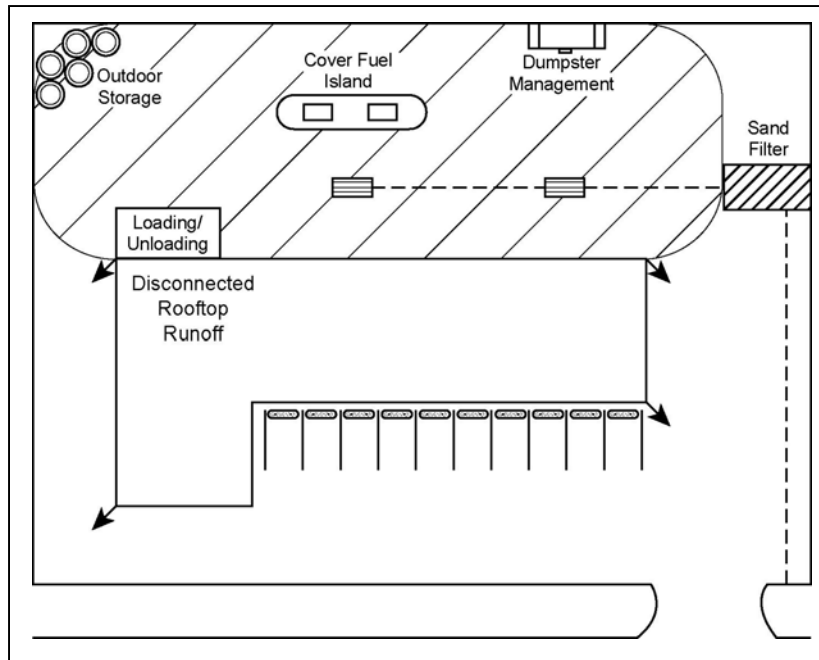

Figure 1: Schematic showing typical treatment at hotspot generating areas.



Figure 2: Sand filters are the preferred stormwater treatment option for hotspot retrofits.

Ideal Conditions for Hotspot Retrofits

Retrofits should always be considered for any operation:

- Found to be a severe hotspot during a hotspot site investigation
- Covered by an existing industrial stormwater permit or specifically designated as a stormwater hotspot in the local water quality ordinance
- Where site investigation shows that pollution prevention practices alone are not sufficient to remove pollutants in stormwater runoff

Situations Where Hotspot Retrofits are Difficult

Most subwatersheds contain dozens or even hundreds of potential stormwater hotspots, but only a fraction of them require on-site stormwater treatment. Hotspots do not need retrofits when:

- Field investigations indicate that the hotspot is not severe
- Legal responsibility to manage the property is unclear (e.g. operator leases the space from property owner)
- Community does not offer technical assistance to help operators install low cost stormwater treatment options
- Site is severely constrained by a lack of head or space

Alternative Restoration Projects at Stormwater Hotspots

A nonstructural approach can effectively prevent pollution from many stormwater hotspot operations. Manual 8 contains 15 different profile sheets that describe pollution prevention practices that can be applied to stormwater hotspots:

- H-1 Vehicle Maintenance and Repair
- H-2 Vehicle Fueling
- H-3 Vehicle Washing
- H-4 Vehicle Storage
- H-5 Loading and Unloading
- H-6 Outdoor Storage
- H-7 Spill Prevention and Response
- H-8 Dumpster Management
- H-9 Building Repair and Remodeling
- H-10 Building Maintenance
- H-11 Parking Lot Maintenance
- H-12 Turf Management
- H-13 Landscaping/Grounds Care
- H-14 Swimming Pool Discharges
- H-15 Unique Hotspot Operations

Desktop Searching for Stormwater Hotspots

The team can isolate areas to search for hotspots in the field by reviewing maps depicting commercial, industrial or municipal land use (Figure 3). Local knowledge can also be helpful. A more systematic approach for finding hotspot sites

involves searching local business databases using standard industrial codes (SIC). Methods for conducting an SIC database search can be found in Appendix A of Manual 8. Another approach to find potential stormwater hotspots is to search databases of industrial operations that hold stormwater permits.

What to Look for When Investigating Hotspots

Procedures to inspect and rank stormwater hotspots are described in the Hotspot Site Investigation (HSI) component of the Unified Subwatershed and Site Reconnaissance (see Manual 11). The HSI involves a rapid visual assessment to inspect site operations that may cause a stormwater hotspot. If a site is ranked as a confirmed or severe hotspot, then the crew looks into the "plumbing" at the site to determine whether additional stormwater treatment is needed beyond standard pollution prevention practices.

Five steps are used to assess the feasibility of on-site treatment at a stormwater hotspot:

1. Define hotspot generating area – In the first step, the crew defines the approximate area of the hotspot generating area (HGA) which is defined as the actual area at the site that is generating higher levels of pollutants (Figure 4). The HGA is usually associated with:

- Vehicle Operations
- Outdoor Materials
- Waste Management
- Physical Plant Maintenance
- Intensive Turf/Landscaping

The HGA often comprises only a fraction of total site area, although more than one may be present at larger sites. The crew should sketch the approximate boundaries of the HGA on the site map.



Figure 3: Hotspots are too small to find on aerial photos but can be found by searching business databases.

2. Evaluate pollution prevention practices -

The crew then evaluates whether the HGA can be fully treated by non-structural practices such as covering, secondary containment, or employee training. Full treatment is operationally defined as no exposure of the polluting operation to rainfall or runoff. If full treatment cannot be obtained, the crew moves to the next step.

3. Evaluate hotspot connection to public storm drain system -

The crew walks the site to understand how the plumbing of the private storm drain system connects to the public storm drain system (Figure 5). In simple terms, this means tracing the path of runoff from the HGA as it crosses the site and enters offsite drainage. The crew should look for all connections to the storm drain system to determine if they are illegal or illicit. Some connections to the storm drain



Figure 4: Common hotspot generating areas to look for during a site investigation: vehicle service/fueling (a); bulk outdoor storage(b); dumpsters (c); truck washouts (d) irrigation/fertilization (e); and chemical drums (f).

system may be located inside a building or under a roof (e.g., shop drains). The existing plumbing then sketched on the site map.

4. Select stormwater treatment option - The crew then evaluates the feasibility of a sand filter or bioretention to treat the hotspot. Head is usually the key feasibility constraint and is defined as the vertical distance between the elevation of the stormwater inlet and the bottom elevation of the existing storm drain system to which it discharges. Most stormwater filter and bioretention designs require three to 10 feet of head. If the entry point is not feasible for a retrofit, the crew moves down-gradient in the storm drain system to look for a more suitable treatment area.

5. Get retrofit design information - Once a suitable treatment area is found, the crew records details to assist in future design efforts, such as the adjusted drainage area, surface and pipe slopes, and notes on soil and subsurface conditions.



Figure 5: A crew member checks for a connection between the HGA and the storm drain system (sometimes it's obvious).

Feasibility and Permitting for Hotspot Retrofits

The major feasibility issue for hotspot retrofits is whether a community has legal authority to enforce on-site treatment of stormwater quality at existing hotspots (i.e., without having to wait until stormwater requirements are triggered by new development or redevelopment applications).

The review of hotspot retrofit designs is fairly straightforward, assuming the local stormwater review authority has experience with filtering and bioretention practices. The review authority may wish to add conditions to maintenance agreements that require testing sediments to ensure trapped sediments are safe for landfill disposal (i.e., are not considered hazardous waste). Communities may obtain greater compliance if they offer direct technical assistance to owners/operators on how to implement stormwater treatment and pollution prevention practices.

Hotspot Retrofit Design

Several key design issues arise when dealing with hotspot retrofits:

The design of each retrofit should control the specific pollutants generated at the stormwater hotspot (e.g., oil, sediment, metals). Manual 8 provides guidance on the types of pollutants generated by different hotspot operations. The designer should also interview the owner/operator to fully understand the operations that routinely occur at the site throughout the year (Figure 6). For example, an otherwise ideal retrofit location may interfere with business operations or impede traffic. In other cases, the hotspot generating area may change with

the season of the year (particularly for outdoor storage).

Pretreatment is essential for hotspot retrofits. Sand filters or bioretention areas should have a two-cell design that enables the first cell to capture and contain spills or transitory flows. If the site experiences chronic flows, the crew should conduct a discharge prevention investigation to determine whether the source of the flow constitutes an illicit discharge (for methods, consult Brown *et al.* 2004). Continuous or chronic dry weather flows should never be discharged into a hotspot retrofit.

Hotspot retrofits require more frequent routine maintenance compared to storage retrofits. Designers should develop a clear plan with specific maintenance tasks, schedules, costs and vendors. Hotspot retrofits should be located on the surface (or just below it) to allow direct access for maintenance and sediment removal. Hotspot retrofits must be clearly marked or posted so they can be easily recognized as a stormwater treatment practice during routine inspections.

Some hotspot sites are so confined that only underground treatment can work (see Profile Sheet OS-13). Designers should avoid



Figure 6: Designers should interview operators to understand seasonal operations

infiltration or any other practice that connects to groundwater (e.g., swales and exfiltrating bioretention).

Design Support

Designers may need key information to support the design of hotspot retrofits:

- Secure original as-built drawings of site drainage.
- Mark the location and elevation of existing utilities.
- Survey the pipe system to determine permissible pipe invert elevations.
- Survey the site to at least a tenth of a foot to determine the precise grade and contributing drainage area to the proposed retrofit. The designer may also want to check these boundaries during an actual storm event.
- Extend soil borings to a depth two feet below the bottom of the proposed retrofit.
- Conduct a discharge prevention investigation if chronic or continuous dry-weather flows are observed.

Design Process

The design process of most hotspot retrofits is fairly straightforward, and involves six steps:

Step 1: The pollutant(s) of concern discovered during the site inspection should be the focus of design.

Step 2: Disconnect or divert any rooftop runoff that “runs on” to the HGA (which helps reduce the water quality storage volume needed for the retrofit)

Step 3: Further minimize the size of the HGA by covering and secondary containment measures.

Step 4: Choose the most effective stormwater treatment option for the retrofit based on site conditions and the pollutant of concern (normally a sand filter or bioretention with an underdrain).

Step 5: Size the retrofit to capture the entire runoff volume from the locally required WQv storm event. Hotspot retrofits should provide extensive pretreatment storage.

Step 6: If the retrofit will bear loads, perform computations to determine if structural reinforcement is needed to withstand expected vehicle loads.

Delivery Considerations for Hotspot Retrofits

Many communities have authority to require on-site retrofits as part of municipal or industrial stormwater permit compliance (although relatively few have exercised it). Widespread compliance, however, can seldom be achieved by permitting alone - technical assistance, employee training, business recognition and even cost-sharing may be needed to encourage small businesses to retrofit their hotspots. Manual 8 describes a carrot and stick approach to obtain greater hotspot compliance.

Construction Considerations for Hotspot Retrofits

Several considerations are important when constructing hotspot retrofits:

- Construction phases should be compressed to minimize interference with existing operations or parking.
- Inspectors should ensure that the top of the filter bed is completely level, the retrofit is water tight, and the connection between private and public storm drains is secure.
- Runoff should be diverted around the retrofit during construction.
- Retrofit maintenance tasks, costs, schedules and vendors should be clearly outlined in the Stormwater Pollution Prevention Plan developed for the site. Employees and facility managers should review the plan annually to schedule maintenance work.

Hotspot Retrofit Costs

The cost to construct hotspot retrofits is primarily based on the stormwater treatment option selected and the specific design variant employed (see Table 1). Other site-specific factors that can drive up the cost of a hotspot retrofit are described in Table 2.

Table 1: Estimated Construction Costs for Stormwater Hotspot Retrofits (2006 \$ per cubic foot treated)			
Stormwater Treatment Option	Median Cost	Range	Design & Engineering (%)⁶
Surface Sand Filter ¹	\$ 5.00	\$ 3.00 to \$ 8.00	35
Structural Sand Filter ²	\$ 20.00	\$ 16.00 to \$ 22.00	35
Underground Sand Filter ³	\$ 65.00	\$ 28.00 to \$ 75.00	35
Multi-chamber Treatment Train	\$ 80.00	\$ 66.00 to \$ 94.00	35
Large Bioretention ⁴	\$ 10.50	\$ 7.50 to \$ 17.25	35
Small Bioretention ⁵	\$ 30.00	\$ 25.00 to \$ 40.00	35
¹ Surface filter in pervious area with minimal concrete or structural features ² Two cell surface or perimeter sand filter with concrete structures ³ Underground filter that can bear traffic loads ⁴ Retrofit serving more than 0.5 acres of CDA with underdrain and bottom liner ⁵ Retrofit serving less than 0.5 acres of CDA with connection to storm drain system ⁶ Higher design & engineering for employee training in pollution prevention and maintenance			

Table 2: Factors that Influence Construction Costs for Hotspot Retrofit Projects	
Factors that Decrease Cost	Factors that Increase Cost
<ul style="list-style-type: none"> • Ability to cover or contain runoff from HGA • Redirecting runoff passing thru HGA • No major changes to existing plumbing • Treatment available on turf or landscaping area • HGA can be reduced through non-structural practices 	<ul style="list-style-type: none"> • Filter needs to bear traffic loads • Grates or bollards needed to protect it • Underground treatment • Pavement repairs needed after construction • Full treatment of the water quality storm

OS-8	On-site Retrofits	
	SMALL PARKING LOT RETROFITS	

This on-site retrofit strategy treats the quality of runoff from existing parking lots less than five acres in area. Surface retrofits can be installed within the parking lot, along its perimeter, or in adjacent pervious areas (Figure 1). A wide range of stormwater treatment options can be adapted for this retrofit, including:

- Impervious Cover Reduction
- Permeable Pavers
- Bioretention Islands
- Perimeter Bioretention
- Perimeter Sand Filter

- Filter Strips
- Infiltration
- Dry Swales

Parking lots are an ideal location for on-site retrofits since they generate extremely high unit area runoff volumes, pollutant loads and temperature spikes. Parking lot retrofits also have great demonstration value due to their high visibility. Figure 2 presents numerous examples of small parking lot retrofit techniques, and a design schematic is shown in Figure 3.

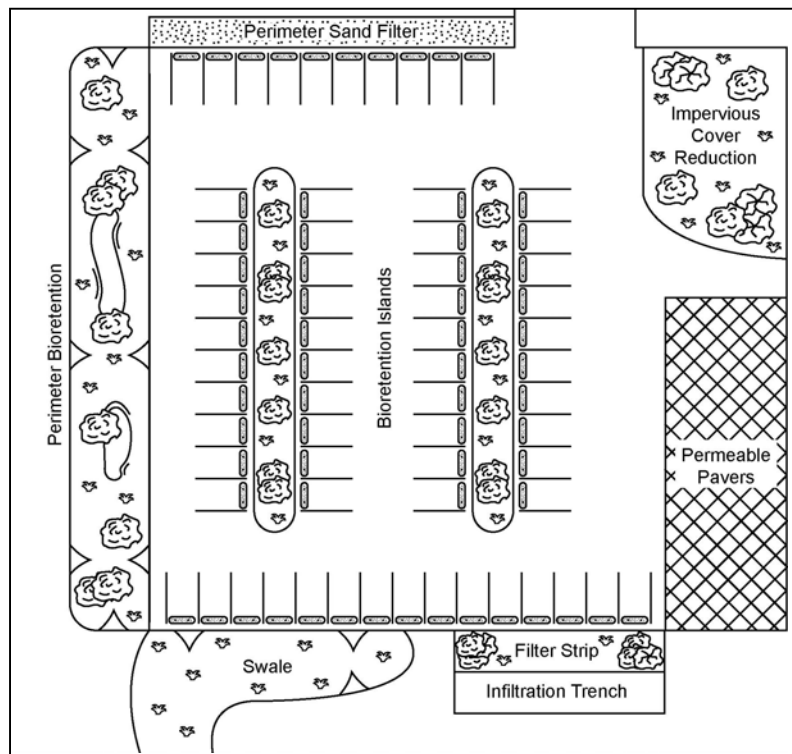

Figure 1: Many different retrofit strategies can be employed to retrofit parts of a smaller lot.



Figure 2: Examples of retrofits employed at small parking lots: permeable pavers (a); dry swale (b); perimeter sand filter (c); grass filter//infiltration trench (d); filter strip (e); internal bioretention (f); underground infiltration (g) and island bioretention (h).

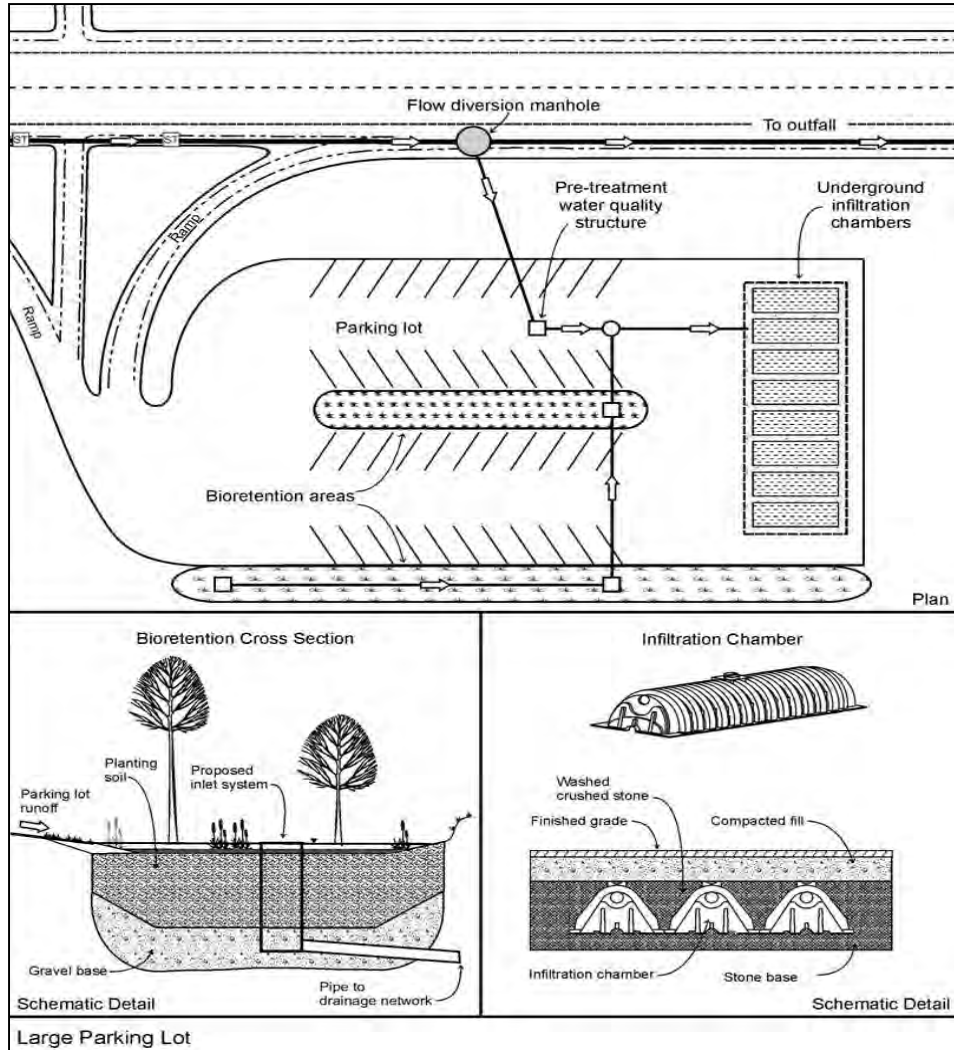

Figure 3: Schematic showing multiple practices treating small parking lot.

Ideal Conditions for Small Parking Lot Retrofits

The best conditions to retrofit small parking lots are when:

- Communities retrofit a municipally-owned parking lot as a demonstration project
- New parking lots are constructed as part of redevelopment or infill projects
- Existing parking lots are slated for resurfacing, reconfiguration or

renovation (their normal design life is about 15 to 25 years)

- Local stormwater regulations trigger water quality control at time of lot renovation or rehabilitation
- Parking lots were built with generous landscaping, open space, screening or frontage setbacks
- Parking lots are not fully utilized because they were designed using excessive parking demand ratios (Figure 4)

Situations Where Small Parking Lot Retrofits are Difficult

Small parking lot retrofits can potentially reduce available parking area, so they are generally not a great option in the following situations:

- Over-crowded parking lots
- Older parking lots built prior to modern design standards for screening, drainage, and landscaping
- Owners are reluctant to sacrifice parking spaces and/or are unwilling to perform future maintenance
- Dry or wet utilities run underneath the parking lot
- The parking lot is located in flat terrain and lacks adequate head

- The parking lot is already served by an effective stormwater treatment practice.

Alternative Restoration Practices for Small Parking Lots

Even if an on-site retrofit is not feasible, the following restoration practices may still be viable:

- *Tree planting* in parking islands, lot margins and setbacks.
- *Vacuum sweeping and litter control* in the parking lot (Figure 5).
- *Parking lot pollution prevention practices*, especially for vehicle storage and parking lot maintenance (see Profile Sheets H-4 and H-11 in Manual 8).



Figure 4: Ideal conditions for retrofitting small parking lots include: adjacent open land (a); unutilized setbacks along margins (b); under-utilized lots (c); and lots needing repair or rehabilitation (d).

Desktop Searching for Small Parking Lots

Small parking lots are generally quite easy to spot on aerial photographs or GIS data layers (Figure 6). A more systematic approach may restrict the search to parking lots in municipal or institutional ownership where permission to retrofit may be easier to get. Otherwise, the feasibility small parking lot retrofits is normally determined in the field.



Figure 5: Routine parking lot sweeping can reduce litter collection in storm drains.



Figure 6: Orthophotos can help find small parking lots and for concept sketches.

What to Look for When Investigating Small Parking Lots

1. *Confirm the size and use of the parking lot* - The crew should estimate the total lot area and any connection with rooftop drainage. Many parking lots are merely a continuation of rooftop drainage, so the crew should check whether rooftop leaders are connected to the parking lot. The size of the parking lot can be estimated using the stall-counting method described in Profile Sheet SR-6. The crew should evaluate parking lot use/capacity to see if some spaces can be sacrificed for stormwater treatment without reducing existing parking needs.

2. *Eyeball parking lot grade and subdivide into smaller drainage units* - This is the tricky part of retrofitting small parking lots. While they appear to be flat, lots have subtle grading to promote drainage to drop inlets or curb cuts. Crews should walk the entire parking lot and trace the surface flow path draining toward the low point(s). The crew can then break up the parking lot into smaller drainage units where flow can be directed to different on-site treatment areas. Curb cuts can also be used to split flows from smaller drainage units to on-site treatment areas.

3. *Evaluate each on-site treatment area for available space* - Potential treatment areas include any unutilized turf, landscaping or paved areas located downgradient from the lot. This may include parking lot islands, the perimeter or margins of the lot, landscaping areas, frontage setbacks and other open space. An on-site retrofit is normally feasible if the proposed treatment area is five to 10 percent of the size of its contributing drainage area.

The crew may want to use a hand auger at the proposed treatment area to get a sense of underground soil quality and infiltration rates. As always, the crew should look for surface indicators of underground utilities that might reduce available area. The crew should carefully review parking lot grading again to get an accurate estimate of the actual contributing area to each on-site retrofit treatment area (and note whether the lot must be regraded during construction).

4. *Determine how the treatment area can be reconnected* to the existing storm drain system and measure the bottom invert of the downstream storm drain. The crew should measure the elevation of pipe inverts of the storm drain pipe closest to the treatment area. These inverts establish what elevation is needed to tie the underdrain from the proposed retrofit area into the storm drain system (Figure 7). In general, four to five feet of elevation above this invert is needed to drive storm water through the proposed retrofit. Designers can avoid the head problem by disconnecting the contributing drainage area from the storm drain system through filter strips, curb cuts, infiltration or permeable pavers.



Figure 7: Understanding the plumbing: measuring pipe inverts at drop inlets.

5. *Sketch the proposed treatment area(s)* and indicate the recommended stormwater treatment option on the RRI field form.

Feasibility, Approvals and Permitting for Small Parking Lot Retrofits

Small parking lots are subject to normal retrofit feasibility constraints. Given the wide range of available stormwater treatment options, however, it is usually possible to find an on-site retrofit option that can treat at least a portion of the lot.

The biggest hurdle is getting permission from the parking lot owner to install the retrofit, which usually means the best sites are located on municipal or institutional land. A stormwater easement may be needed to connect to the downstream storm drain system.

Small parking lot retrofits seldom require many environmental permits. It is advisable to interview the facility manager to understand seasonal uses and pollutant loadings (Figure 8). A grading permit and stormwater design approval may be required by the local stormwater review authority.

Small Parking Lot Retrofit Design

Design Support

- Original drawings from the development plan that show the storm drain profile and inverts.
- Soil borings or test pits to determine soil quality and infiltration rates.



Figure 8: Interview property managers to anticipate seasonal uses and pollutant loads.

- Survey data to get accurate delineation of contributing drainage area (e.g., to a tenth of a foot).
- Spot elevations of the storm drain inverts if original drawings do not exist.
- Marking the location and depth of any underground utilities
- Parking demand studies during peak use (daytime, evening, weekend) to document lot capacity.

Design Process

The design of small parking lot retrofits is fairly straightforward, and depends on the type of stormwater treatment option. In general, the design process is the same as a new stormwater practice. Specific design considerations include:

- Hydraulic analyses may be needed on the existing storm drain system to ensure nuisance ponding will not occur, particularly in situations where head is limited
- The location of the retrofit may be dictated by the space needed for construction access

- It may be possible to direct sheet flow over to a parking lot filter strip as shown in Figure 9.

Construction Considerations for Small Parking Lot Retrofits

Retrofit construction may result in temporary closure of portions of the parking lot, so designers should sequence construction to occur quickly during periods of minimal parking use. Other construction considerations include:

- Install temporary fencing to prevent public access to the construction site.
- Specify smaller construction equipment to minimize damage to the parking surface and avoid soil compaction.
- Make provisions for temporary parking during construction, if needed.
- Make sure the construction budget includes contingency costs to repair existing pavement, curbs, pavement markings, trees or landscaping that might be damaged during construction.
- Include care and replacement warranties to ensure landscaping material survives beyond the first growing season.

Costs for Small Parking Lot Retrofits

The cost to construct small parking lot retrofits depends on the stormwater treatment option selected (Table 1). Retrofit costs will be higher, if any of the site-specific factors outlined in Table 2 occur at the project site.

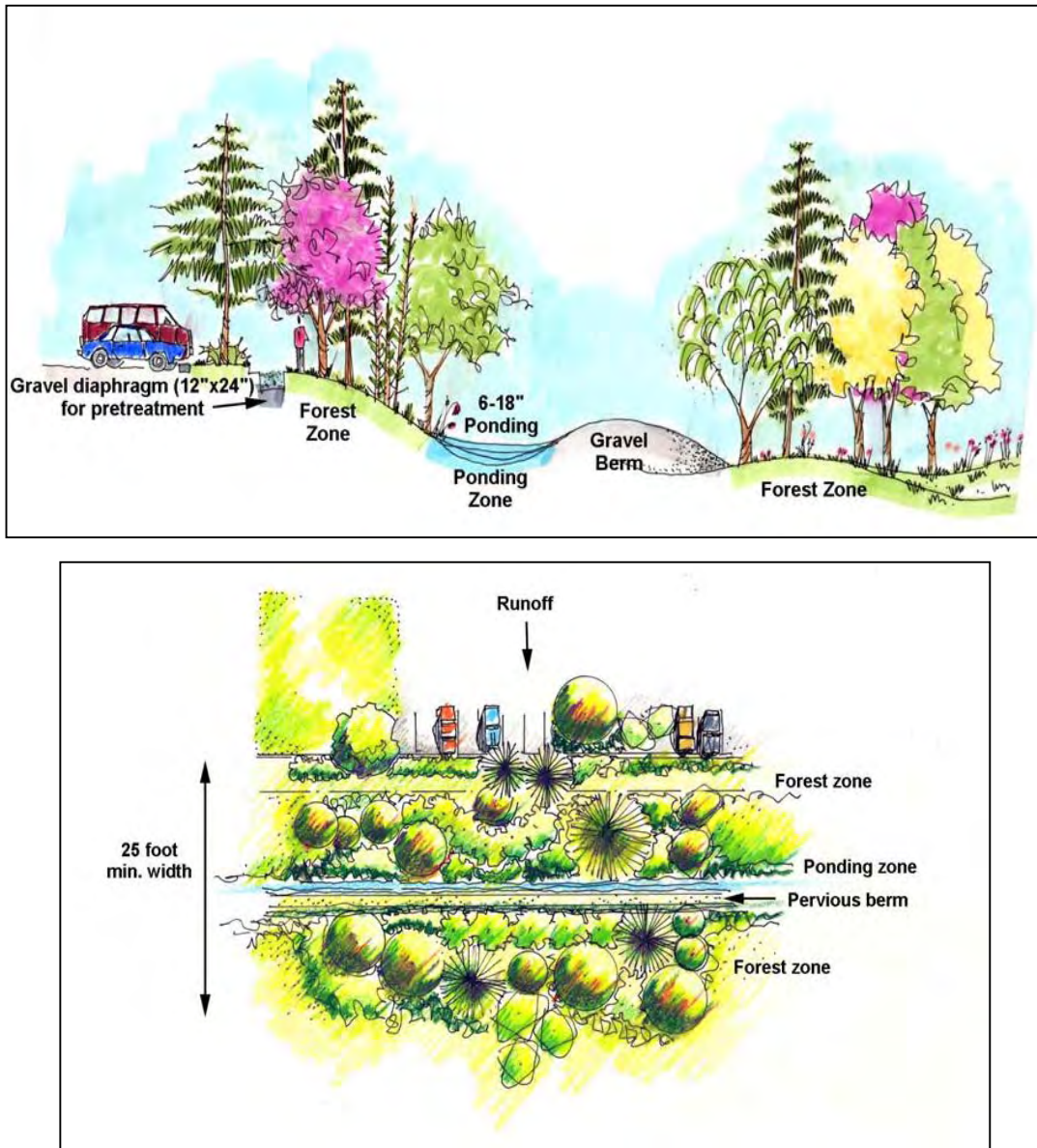



Figure 9: Plan and profile view of simple forested filter strip design for a parking lot.

Table 1: Estimated Construction Costs for Small Parking Lot Retrofits (2006 \$ per cubic foot treated)			
Stormwater Treatment Option	Median Cost	Range	Design & Engineering (%)
External Bioretention ¹	\$ 10.50	\$ 7.50 to \$ 17.25	32
Internal Bioretention ²	\$ 30.00	\$ 25.00 to \$ 40.00	32
Surface Sand Filter ³	\$ 5.00	\$ 3.00 to \$ 8.00	32
Perimeter Sand Filter ⁴	\$ 20.00	\$16.00 to \$ 22.00	32
Filter Strip ⁵	\$ 5.00	\$ 3.50 to \$ 10.00	15
Parking Lot Swales ⁶	\$ 12.50	\$ 7.00 to \$ 22.00	15
Perimeter Infiltration ⁷	\$ 15.00	\$ 10.00 to \$ 23.00	32
Permeable Pavers ⁸	\$ 120.00	\$ 96.00 to \$ 144.00	15
IC Conversion ⁹	\$ 20.00	\$ 18.50 to \$ 21.50	15
¹ Located outside of the parking lot ² Bioretention installed within parking lot islands or elsewhere on the lot ³ Non-structural surface sand filter located on the perimeter of parking lot ⁴ Structural sand filter within the parking lot that bears load ⁵ Grading, level spreader and re-vegetation at perimeter of parking lot ⁶ Water quality swale draining a portion of the parking lot ⁷ Infiltration with pretreatment at perimeter of parking lot ⁸ Permeable paver blocks within lot, along with subgrade preparation ⁹ Demolition and removal of IC with soil and grass replacement			

Table 2: Factors that Influence Construction Cost of Small Parking Lot Retrofits	
Factors that Decrease Cost	Factors that Increase Cost
<ul style="list-style-type: none"> • Parking lot is under-capacity • High soil infiltration rates • Use of filter strips, swales or infiltration • Lot is scheduled for rehabilitation • Wide setbacks along lot perimeter 	<ul style="list-style-type: none"> • Design to bear traffic loads • Additional landscaping and tree planting • Complicated construction sequence • Need to repave lot • Need for underdrains

OS-9	On-site Retrofits	
	INDIVIDUAL STREETS	

This group of on-site retrofits provides stormwater treatment within the roadbed or right of way of individual streets. A wide range of retrofit strategies can be employed depending on whether the street has open or closed drainage:

- Install stormwater treatment within open section drainage
- Convert enclosed drainage into open section and install stormwater treatment practices
- Divert stormwater for surface treatment before it enters the storm drain
- Make storm drain pipes less efficient at delivering stormwater by promoting infiltration in the storm drain pipe.

Stormwater treatment options for open section street retrofits include dry swales,

grass channels, bioretention cells and wet swales. Streets with closed drainage may utilize street bioretention, expanded tree pits, cul-de-sac bioretention, catch basin inserts or perforated storm drain pipes. Figure 1 illustrates the many different ways stormwater treatment can be applied to street retrofits.

Streets are a significant urban pollutant source area and act as the primary conduit to move stormwater runoff from rooftops, lawn and driveways. Street retrofits treat stormwater near the source, improve neighborhood appearance, calm traffic and act as a focal point to educate adjacent residents about stormwater quality. Creative techniques to retrofit streets are shown in Figures 2 through 4.

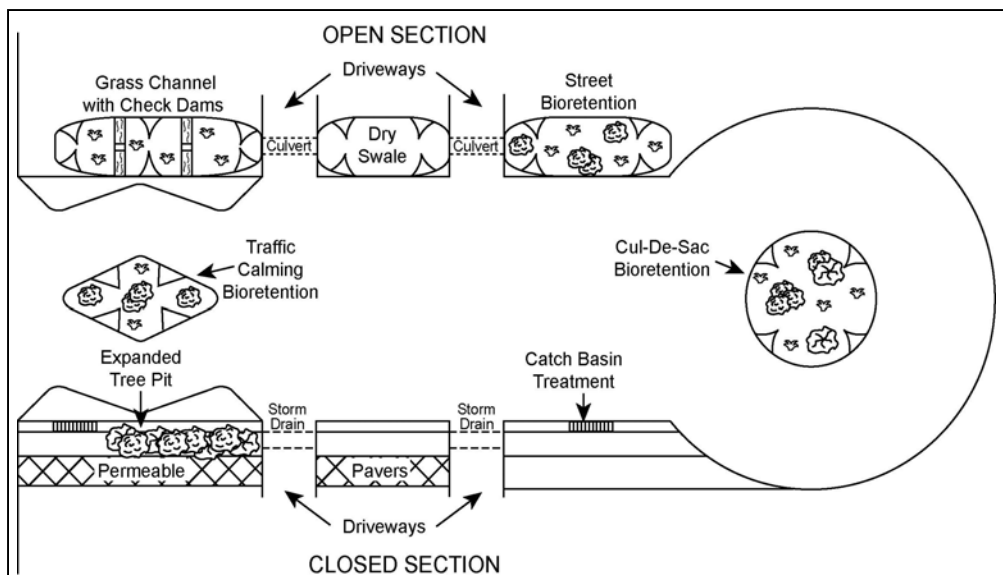

Figure 1: Retrofit strategies depend on whether the street has open or enclosed drainage.

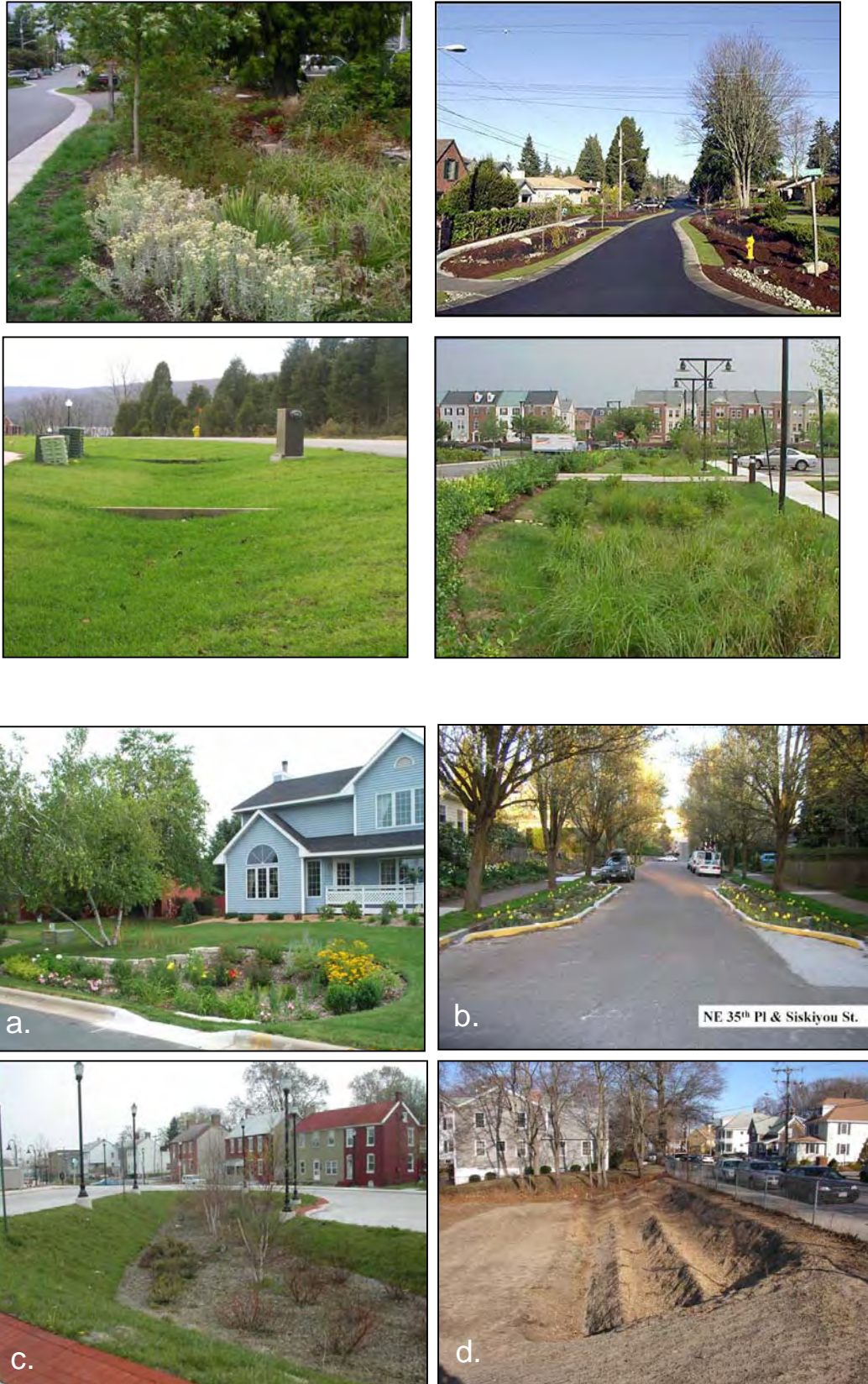

Figure 3: Innovative street retrofits include: curb cuts to rain gardens (a), surface bioretention in traffic calming measures (b), larger bioretention pocket in multi-family residential (c), and curb cuts to cascading bioretention cells (d).



Figure 4: More street retrofit ideas: SEA streets swale (a); close-up of Portland street bioretention (b) and bioretention in street medians (c/d).

Ideal Conditions for Street Retrofits

Most communities maintain hundreds or even thousands of residential street miles (Law, 2006). Key suitability factors for street retrofits are shown in Figure 5 and include:

- Streets classified as having a moderate to severe pollution severity, as measured by field surveys.
- Neighborhoods that request traffic calming devices to slow residential speeding
- Streetscaping projects or neighborhood revitalization efforts where street drainage can be modified
- Bundling retrofits as part of upcoming water and/or sewer rehabilitation projects
- Wider streets that serve large lots (1/2 acre lots and up)
- Wide street right of ways that provide room for stormwater treatment options
- Streets where utilities are located underneath the pavement or on only one side of the street



Figure 5: Ideal conditions for street retrofits include a wide right of way (a), excessively wide streets (b), open section drainage channels (c), and large cul-de-sacs (d).

Situations Where Street Retrofits are Difficult

Only a fraction of residential streets are good candidates for retrofits (Figure 6). Retrofits are not a good idea for streets that:

- Are not currently scheduled for streetscaping or renovation
- Have longitudinal slopes greater than 5%
- Are classified as arterial or connector roads
- Have extensive upland contributing drainage area
- Are slated to be widened to accommodate future traffic capacity
- Have mature street trees or intensive residential landscaping
- Have a narrow right of way or heavy on-street parking demand
- Have very small lot sizes (i.e., the driveway effect)
- Lack an active homeowners association
- Have wide sidewalks on both sides of the street

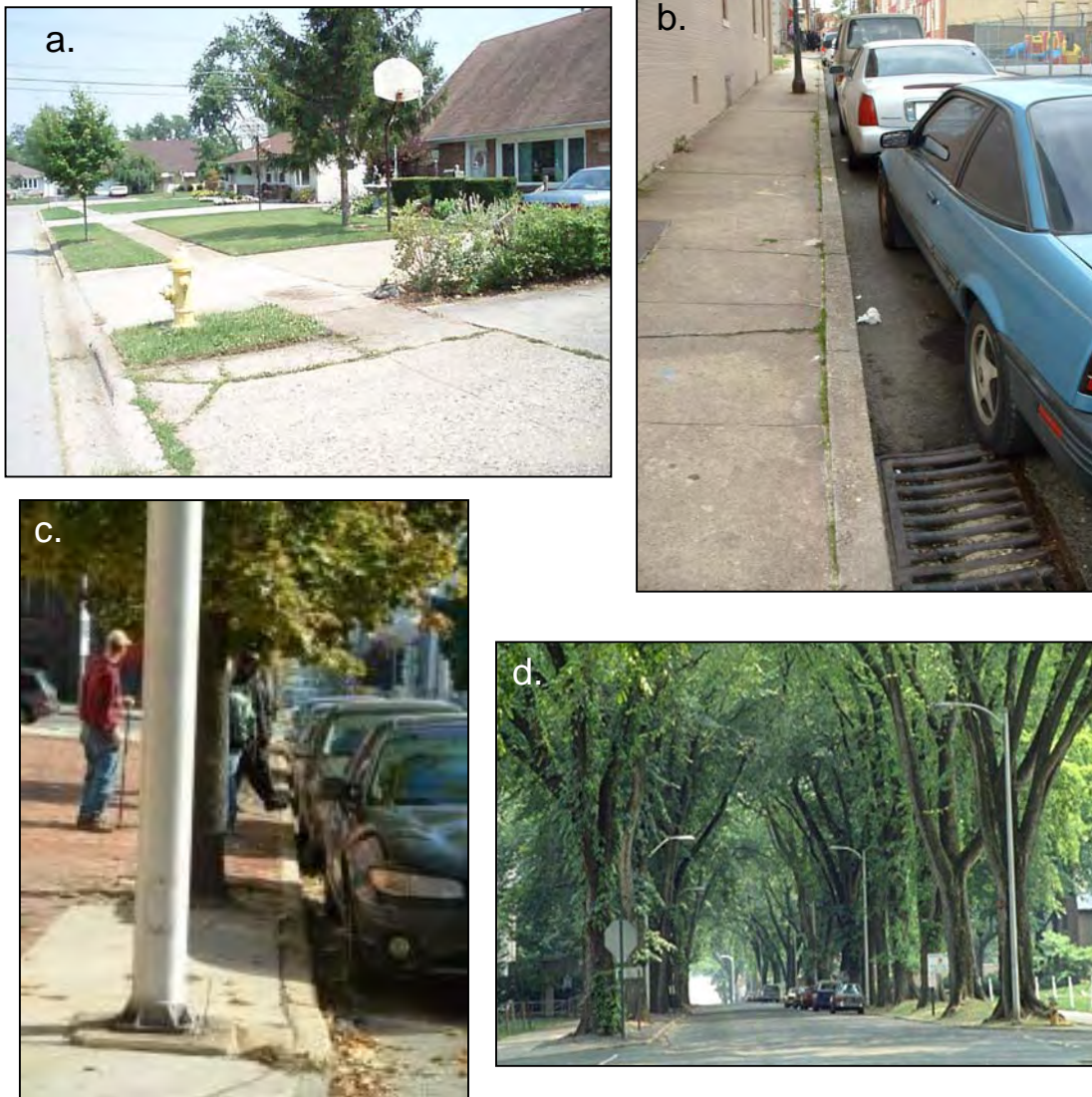

Figure 6: Conditions that make street retrofits difficult include: small lots and multiple driveways (a), on-street parking demand (b), underground and overhead utilities (c), and mature street trees (d).

Alternative Restoration Projects for Streets

Alternative restoration projects that can be applied to streets include:

- Street Sweeping
- Storm Drain Cleanouts
- Storm Drain Marking (see Profile Sheet N-21 in Manual 8)
- Watershed Education and Stewardship
- Neighborhood Pollution Source Controls (Manual 8)
 - Natural Landscaping
 - Soil Erosion Repair
 - Safe Car Washing
 - Driveway Sweeping
 - Car Fluid Recycling

Desktop Searching for Street Retrofits

The first place to look for potential street retrofits is the municipal capital improvement budget, which indicates future street or sewer improvements scheduled in a subwatershed where retrofits might be bundled. In addition, the team may want to focus on neighborhoods with a history of drainage or basement flooding problems. An advanced GIS query can narrow down the number of streets by looking at street feasibility criteria such as slope, right of way width, open section drainage, presence/absence of sidewalks, parking lanes and adjacent lot size.

If a USSR has been conducted, Street and Storm Drain (SSD) or Neighborhood Source Assessment (NSA) forms should be reviewed. These forms calculate a pollution severity index for streets, and help rank potential street retrofit sites. The forms and associated photos also provide insights into the condition of the sidewalk zone and street pavement.

What to Look for when Investigating Streets

The crew investigates the general condition of the street and its right-of-way in three areas:

1. The crew observes the following conditions at the street:

- Pavement width
- Longitudinal and lateral slope
- On-street parking demand
- Traffic volume
- Pavement condition
- Pollutant accumulation in curbs or gutters
- Distance between driveways

2. Next the crew inspects the right-of-way and front yards to ascertain the:

- Condition of sidewalk zone
- Setback distance of houses
- Homeowner encroachment
- Density of vegetative cover
- Presence/absence of street trees

3. The crew then notes the location and elevation of the downstream discharge point or its entry into the storm drain system.

If a street has open section drainage, the retrofit crew should record:

- Existing channel cross-section and sideslope dimensions
- Grade/head available, using a 100 foot tape measure
- Available width free of underground or overhead utilities (one or both sides of street)
- General condition of the ditch line (e.g., vegetative cover and density, evidence of erosion, standing water)
- Average distance between driveway culverts

The crew records different retrofit feasibility factors for streets with enclosed storm drains:

- Location of all storm drain inlets, recording size and type (curb vs. grate).
- The crew should pull manholes or inlet grates at proposed retrofit locations and measure the depth, invert and gradient of underground storm drain pipes (Figure 7).
- If catch basins are present in the inlet, crews should measure the depth of pool water, trapped sediment or organic debris

- The crew should look for street covers and markings that indicate the presence of underground utilities that might interfere with construction.
- Locations on the street where treatment could be provided before runoff enters a storm drain inlet (e.g., cul-de-sacs, sidewalk zone, expanded tree planters, etc). Normally, the best locations are just upstream from inlets where curb cuts can divert runoff for treatment.



Figure 7: Crews check storm drains, grate inlets or manholes to determine depth of enclosed storm drainage.

The crew then sketches a preliminary concept design for the proposed street retrofit on the RRI field form.

Feasibility and Permitting for Street Retrofits

Street retrofits require extensive consultation and community relations, since they are located in the front yards of residents. These retrofits can only proceed if they are strongly endorsed by the entire neighborhood. Street retrofits should always reinforce other neighborhood concerns, such as traffic calming, street trees, improved drainage, enhanced landscaping and pedestrian safety. In addition, designers should anticipate resident concerns about trash accumulation, mowing, on-street parking, standing water and nuisance conditions.

Since street retrofits are a new concept, designers may need approval or support from multiple agencies (e.g., water, sewer and dry utilities, and forestry, public safety and road maintenance agencies). Each of these parties has a strong interest in what happens in the street right of way, so designers will need to coordinate with each to satisfy their concerns.

Street Retrofit Design

Street retrofits have several unique design issues.

Since street retrofits affect many adjacent residents, designers should place a premium on enhancing neighborhood appearance and landscaping. Mature street trees should be considered sacred and never be cleared.

Retrofit designs should always try to separate sidewalks from the street edge to promote greater pedestrian safety. Other

street design standards that influence retrofitting include minimum turning radius, curb height, and handicapped access requirements. Some reviewers may want to see calculations of gutter spread to ensure street ponding is kept to an acceptable level.

Designers should choose plant species that can be realistically maintained by adjacent owners. For example, turf and herbaceous plants may require more ongoing maintenance than trees and shrubs.

The high compaction of the road corridor often makes infiltration an unsuitable stormwater treatment option. If soils are limiting, the retrofit will need an underdrain that ties into the existing storm drain system.

Utilities constrain the location of street retrofits, so designers should become familiar with the minimum vertical and horizontal setback requirements for underground and overhead utilities.

Third pipe or in-pipe storage are an alternative design for enclosed street sections. In a third pipe system, a perforated pipe with gravel bedding carries low flows (OME, 2002). Higher flows fill the low flow pipe and are conveyed through the traditional storm drain pipe. In-pipe storage requires oversized storm drain pipes and orifice plates to restrict the storm flow rate.

The responsibility for routine landscaping and structural repairs should be legally established when individual homeowners are expected to maintain a retrofit located in the street right of way.

Design Support

Several studies are needed to support the design of street retrofits:

- As-built drawings and design computations for the street, storm drains and sewers.
- Door to door notification of residents about the project
- Road, pipe, channel, curb and catch basin elevations and locations.
- Soil borings or test pits to determine soil quality and infiltration rate
- Depth and location of underground utilities. Many dry utilities (e.g., phone, cable, gas, and electric) are installed well after initial construction and may not be drawn on original engineering plans. In addition, water and sewer laterals from the house to the street are seldom shown on development plans. Each type of utility must be located prior to street retrofit design.

Design Process

The retrofit design process depends on whether the street has open or closed drainage, and what stormwater treatment option is employed. The design process for open section street retrofits is similar to that described for conveyance retrofits (Profile Sheet SR-4) and consists of four steps:

Step 1: Delineate the drainage area to each proposed street retrofit and compute target WQv storage needed. Confirm that available storage in the proposed retrofit can meet the target volume

Step 2: Model the existing hydraulic capacity of the open channel based on the design storm established by the local review authority.

Step 3: Determine whether water quality treatment cells will be created by checkdams, constrictions at driveway culverts, expanded channel cross-sections or replacement of existing soils with a more

permeable media. The designer should also carefully consider how runoff will pass under driveways and sidewalks (Figure 8).

Step 4: If channel dimensions change due to the street retrofit, designers should redo the hydraulic analysis for the two-year design storm (to ensure conditions are non-erosive) and that the channel can still safely accommodate the 10-year storm.

The design process for closed section retrofits depends on whether runoff is treated at the surface or within the pipe. If runoff is diverted at the road surface prior to entry to the storm drain pipe, no hydraulic modeling is needed. The design of surface retrofits is generally dictated by the design guidelines for the specific stormwater treatment option employed. Several additional retrofit design considerations may also apply:

- Some reviewers may want to see evidence that the surface retrofit will not saturate the roadbed
- Since surface retrofits parallel the road, designers should examine how any changes in longitudinal slope will



Figure 8: Designers need to find creative ways to pass runoff across driveways and sidewalks.

- influence temporary street ponding.
- Designers should show how runoff rates in excess of the treatment volume will bypass the retrofit and return to the storm drain system.

A hydraulic analysis is needed when an enclosed pipe is converted into an open channel. Designers should follow the design process for stream daylighting described in Profile Sheet R-27 in Manual 4.

Street Retrofit Delivery Considerations

A community should consider developing a comprehensive program to coordinate the delivery of neighborhood street retrofit, education and municipal stewardship services. Since street retrofits are a new concept, communities may want to construct demonstration projects to convince local skeptics. Seattle’s SEA Streets program is an excellent example of how street retrofits can be delivered on a widespread basis (Figure 9). Neighborhoods across Seattle now compete for the privilege of getting a street retrofit, and their popularity has greatly expanded funding for streetscaping projects. Over time, communities should look for creative ways to incorporate street retrofits into the design of all municipal streetscaping, water and sewer rehabilitation, and neighborhood revitalization projects.

Construction Considerations for Street Retrofits

The high neighborhood visibility of street retrofits requires a very sensitive construction approach that responds to neighborhood concerns. Some key considerations include:

- Every neighborhood tree seems to have its own advocate, so remove as few mature trees as possible.
- Construction crews should have an on-site supervisor experienced in community relations who can quickly respond to resident complaints and resolve them.
- The construction sequence should strive to provide continuous driveway and sidewalk access for local residents (Figure 10).
- A maintenance of traffic plan will be needed on busier residential streets.
- Erosion and sediment control needs to be taken extremely seriously throughout retrofit construction.

- Street retrofit inspections should focus on getting the correct elevations, grades and cross sections for the pipe or channel, assuring proper connection of underdrains to the storm drain system, and rapidly stabilizing areas with vegetation and landscaping.

Street Retrofit Costs

Construction costs for street retrofits largely depend on the stormwater treatment option used (Table 1). It is generally less expensive to retrofit open-section streets than closed-section streets. Some street-specific factors that influence the cost of street retrofits are outlined in Table 2.



Figure 9: Aerial shot of Seattle SEA Streets retrofit.



Figure 10: Construction sequencing is critical to maintain driveway access and minimize disruption to homeowners.

Table 1: Estimated Construction Costs for Various Street Retrofits (2006 \$ per cubic foot treated)			
Stormwater Treatment Option	Median Cost	Range	Design & Engineering⁷ (%)
Water Quality Swale ¹	\$ 12.50	\$7.00 to \$22.00	35
Dry Swale ²	\$ 23.00	\$ 13.00 to 31.50	35
Bioretention Cells ³	\$ 30.00	\$ 25.00 to \$40.00	35
Street Bioretention ⁴	\$ 18.00	\$15.00 to \$24.00	35
Stormwater Tree Pits ⁵	\$ 70.00	\$ 58.00 to \$83.00	35
Daylight Enclosed Pipes ⁶	\$ 46.00	\$ 26.00 to 63.00	40
¹ Conversion of existing grass channel into water quality swale ² Channel conversion, using urban bioswale costs reported by Hoyt (2007) ³ Construction of new bioretention in street right of way ⁴ Surface bioretention using curb extensions and other methods ⁵ Expanded tree pits to treat stormwater on more urban streets ⁶ Conversion of enclosed drainage to dry swale or bioretention. No cost data available; assumed to be twice the cost of dry swale ⁷ Higher design & engineering for neighborhood consultation and utility negotiations			

Table 2: Site-specific Factors that Reduce the Cost of Street Retrofit Projects	
Factors that Reduce Costs	Factors that Increase Costs
<ul style="list-style-type: none"> • Open section retrofits • No modification of road surface • Wide street right of way • Active civic or neighborhood group • Utilities located under pavement 	<ul style="list-style-type: none"> • Closed section retrofits • Multiple driveways • Utility relocation • Legal resources to define right-of-way or easements • Additional landscaping

<h1>OS-10</h1>	On-site Retrofits	
	<h2>INDIVIDUAL ROOFTOPS</h2>	

This group of onsite retrofits captures, stores, treats and then gradually releases runoff from individual rooftops. The goal is to systematically retrofit as many residential and non-residential rooftops as possible within a given subwatershed. The many different ways that rooftops can be retrofitted are portrayed in Figure 1. A variety of stormwater treatment options can be employed for rooftop retrofits as shown below:

Residential rooftops

- Simple Disconnection
- Rain Barrels
- Rain Gardens
- French Drain/Dry Wells

Non-residential rooftops

- Simple Disconnection
- Rain Gardens
- Stormwater Planters
- Cisterns
- Green Rooftops

Examples of rooftop retrofit techniques are shown in Figures 2 through 4. Additional details on each technique can be found in the Rooftop Retrofit Design Sheets provided in Appendix F. Rooftop retrofits are ideal when a comprehensive delivery system is developed to implement them on a widespread basis. From a cost-benefit standpoint, it makes more sense to target residential rooftops first since they comprise a greater fraction of subwatershed area and are less expensive on a unit-area treated basis.

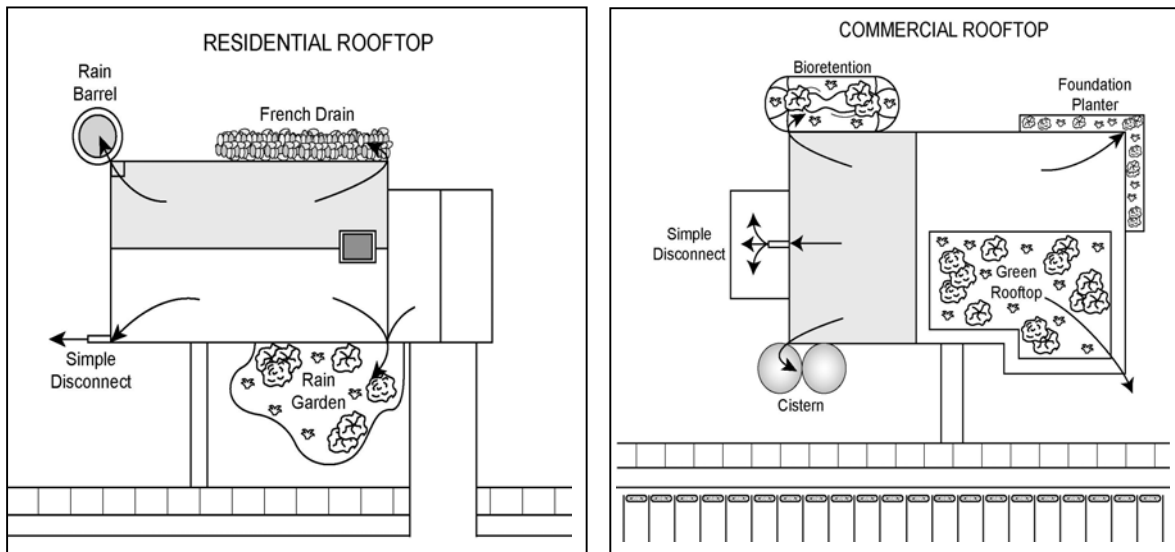

Figure 1: A variety of retrofit strategies can be applied to treat the quality of runoff from residential and commercial rooftops.



Figure 2: Residential rooftops can be treated by french drains (a), rain barrels (b), or rain gardens (c&d).



Figure 3: Runoff from larger rooftops can be treated in cisterns (a), infiltration areas (b), or bioretention planting beds (c).

Rooftop retrofits are particularly well-suited in subwatersheds where runoff reduction is a major restoration goal (e.g., to reduce the volume of stormwater runoff entering a combined sewer system). Retrofitting rooftops for water quality purposes is less effective since rooftop runoff tends to be cleaner than other urban source areas (with the possible exception of metals). On the other hand, incremental rooftop retrofitting can be an effective long range strategy to control runoff in highly urban subwatersheds.

Ideal Conditions for Rooftop Retrofits

The ideal conditions to retrofit residential rooftops are when a neighborhood:

- Has no basements (if infiltration is used)
- Has homes where roof leaders are directly connected to storm drain system
- Is located in a subwatershed where stormwater reductions can reduce combined sewer overflows
- Has a strong neighborhood association, environmental concern or community activism
- Has medium density residential lot sizes in the 0.25 to 1.0 acre range.

Rooftop retrofits work best in non-residential settings when the rooftop:

- Is being built as part of redevelopment or infill project
- Is owned or being built by a municipality or a cooperative institution
- Can discharge to landscaping or open space adjacent to the building
- Has reached the end of its design life and needs replacement.
- Is large, flat and directly connected to the storm drain system
- Owner is interested in green building certification



Figure 4: Green rooftops can also treat the quality of runoff from flat rooftops.

- Retrofit can provide supplemental irrigation to existing landscaping (arid climates)

Situations Where Rooftop Retrofits are Difficult

Most communities have thousands of rooftops but not all of them can be retrofitted. Some common situations where residential rooftops are not feasible include:

- Neighborhoods with basements and sump pumps
- Large residential lots where most roof leaders are already disconnected (<1 acre lots)
- Small residential lots (less than 4,000 square feet) that lack room for a retrofit
- Neighborhoods that lack environmental awareness or community organization
- Lots that lack yards or have poor vegetative cover
- Lawns with extremely compacted or tight soils

There are also situations where non-residential rooftops are difficult to retrofit:

- No open space or landscaping areas are present near building
- Rooftop has internal building drains (i.e., no downspouts)
- Building has a basement or its foundation lacks waterproofing

Alternative Restoration Methods for Rooftops

If rooftop retrofits are impractical, it is still possible to educate their occupants to adopt neighborhood stewardship or pollution prevention practices (Manual 8).

Desktop Searching for Rooftop Retrofits

A search is not very helpful in finding individual rooftop retrofit sites, although the average age and lot size in a neighborhood are worth assessing, since homes built to the same drainage standards tend to have similar retrofit potential (Figure 5). Rooftop retrofit potential can also be assessed using the Neighborhood Source Assessment of the USSR (Figure 6). Another GIS search option is to look for specific neighborhoods that deliver stormwater into combined sewers or have historic flooding or drainage problems. Rooftop retrofits alone may not solve these problems, but can play a role in a larger package of retrofit solutions.

A GIS search that defines older commercial, industrial or institutional zones that are near the end of their design life may help find good candidates for non-residential rooftop retrofits. A search of all municipal buildings in a subwatershed may also be warranted to assess their suitability for demonstration retrofits.



Figure 5: Desktop searches should emphasize neighborhood age to define rooftops built in the same design era.



Figure 6: The Neighborhood Source Assessment (NSA) of the USSR is a useful method to determine the extent of downspout connections in a neighborhood.

What to Look for When Investigating Rooftops

Rooftop retrofit potential can be discovered through a simple neighborhood investigation:

1. Interview homeowners to gauge their willingness and preferences for retrofitting and understand their home drainage issues
2. Evaluate general rooftop conditions in the neighborhood (e.g., pitch, gutters, overhead tree canopy)
3. Pace the width and depth of the average home and estimate the contributing roof area to each roof leader (Figure 7)
4. Trace the pathway of the roof leader to the storm drain system in the street. If the roof leader is plumbed directly to the storm drain, note the depth and location of the pipe connection.
5. Measure the length of the flow path from the roof across pervious areas such as

lawn and landscaping that may be suitable for disconnection

6. Use screwdriver or soil auger to get a sense of lawn compaction and soil quality
7. Determine the most suitable retrofit technique for each roof leader using the flow chart in Figure 8. Note that more than one retrofit technique may be needed for each residential roof.

The investigation for non-residential rooftops is much the same, although roof drainage area is larger and more complex (Figure 9). The crew should first look at more cost-effective options such as bioretention, cisterns and disconnection. If the owner is interested in green rooftops, the crew will need access the roof to assess its age, condition and structural capacity.

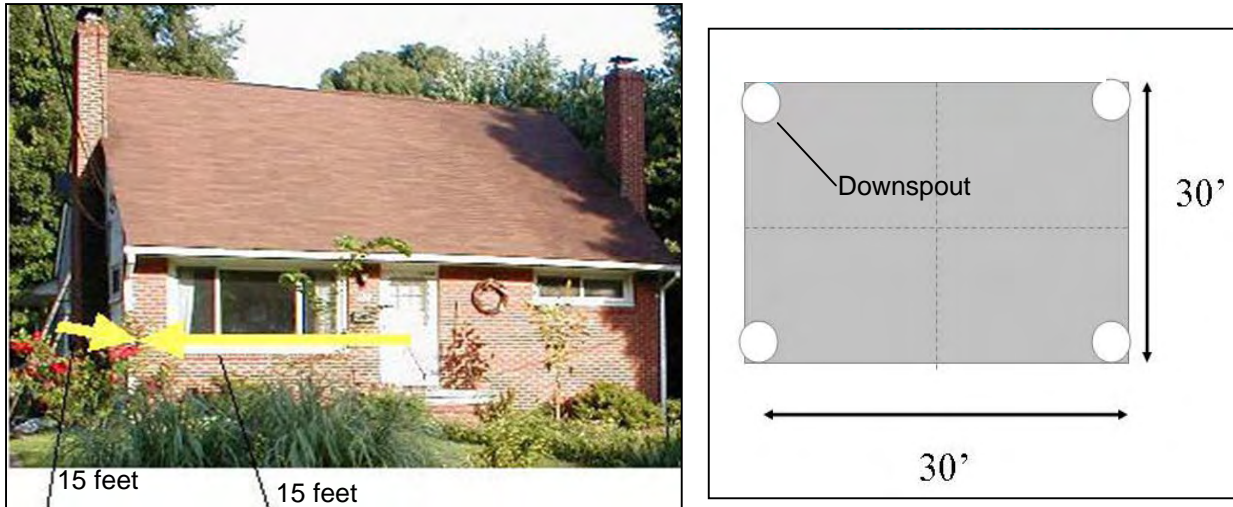

Figure 7: Sizing of residential retrofits is based on simple measurements of roof area draining to each downspout.

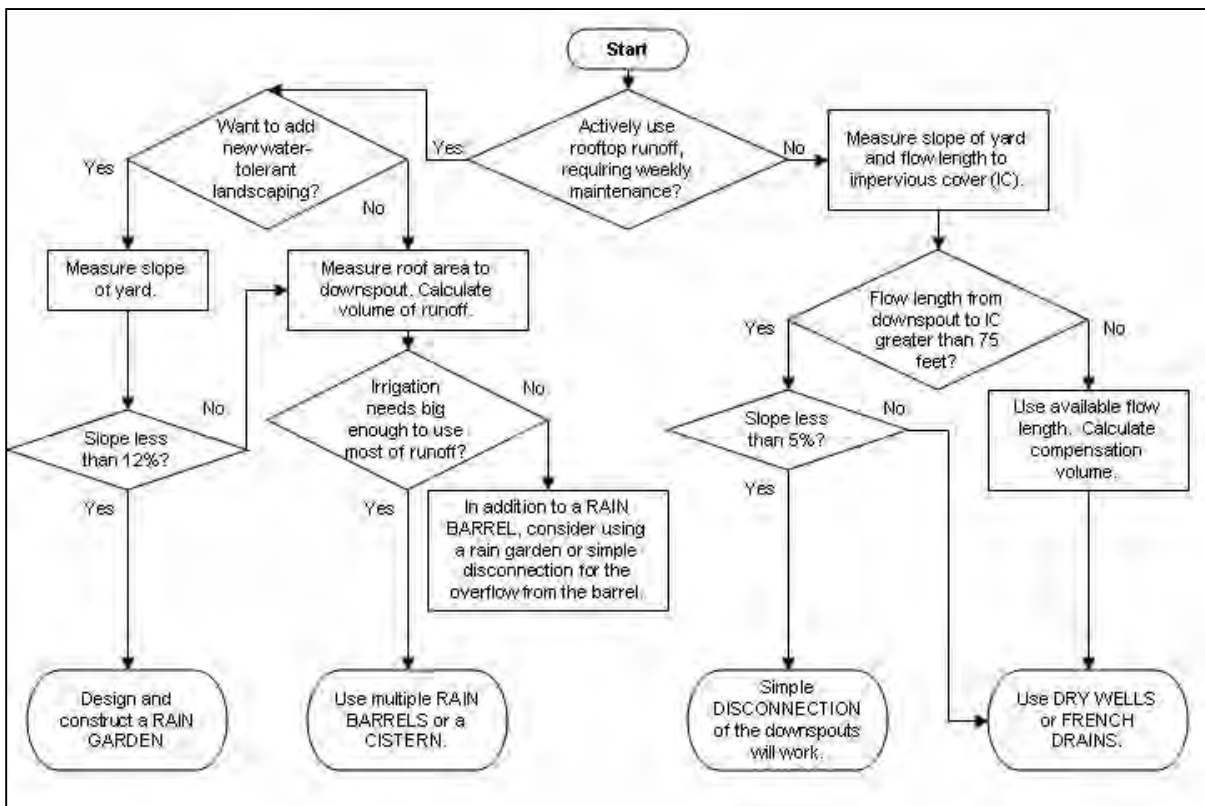

Figure 8: This simple flow chart helps homeowners decide whether simple disconnection, rain barrels, french drains or rain gardens are most appropriate for their lot.

Feasibility and Permits for Rooftop Retrofits

Since residential rooftop retrofits are installed and maintained by private landowners, the real hurdle is convincing them to do so. Some excellent publications exist on how to address perceived concerns about maintenance, algae and mosquito control (see Appendix F). Few environmental permits or approvals are needed, unless a stormwater plan is required under the redevelopment process. Designers may need to submit documentation about the retrofit to qualify for green building certification.

Rooftop Retrofit Design

The design requirements and level of engineering support are different for each rooftop retrofit. Some are exceedingly simple, while others involve complex structural engineering. The designer should consult the individual rooftop retrofit design

sheets in Appendix F for the relevant design process.

Rooftop Retrofit Delivery Considerations

Because each rooftop retrofit treats a small area, dozens or hundreds are needed to make a measurable difference in a subwatershed. Consequently, an effective delivery system is needed to make rooftop retrofits happen, which normally involves a combination of targeted education, technical assistance and financial subsidies to individual homeowners or business community (Figure 10). In some cases, communities may need to modify their current building codes to permit green rooftops and cisterns. Several excellent examples of effective local rooftop retrofit delivery programs are presented in Table 1. These innovative programs have achieved a residential adoption rates ranging from 13 to 55%. Many of their educational and program materials are a good starting point to craft a local retrofit delivery system.



Figure 9: Retrofitting of non-residential rooftops is more complex.



Figure 10: Education and public involvement are key tools to maximize delivery of rooftop retrofits.

Table 1: Case Studies of Rooftop Retrofit Delivery	
Municipal Program	Delivery Mechanisms and Financial Incentives
<p>City of Bremerton, WA <i>Cooperative Approach to CSO Reduction</i> CSO reduction. Disconnection of downspouts became mandatory in the City's combined sewer area. 33% of notified properties were assessed. Of these, the 16% that were contacted were disconnected.</p>	<p>Outreach campaign through by utility bill inserts, billboards, radio, buses and newspaper ads, workshops, direct mail, instructional videos, cable TV, and website. Free downspout assessments by 4 City staff, disconnections done by private contractor or homeowner. \$25 to \$500 mini-grants to support residential disconnection</p>
<p>Pittsburgh, PA <i>Nine Mile Run Rain Barrel Initiative</i> CSO reduction, water quality improvement and inflow & infiltration reduction in pilot subwatershed. 13% of contacted owners participated.</p>	<p>Local watershed association, directed outreach campaign via direct mail, door-to-door canvassing and newspaper, posters and radio ads. Free rain barrel assessment and installation by trained student volunteers (Student Conservation Association and AmeriCorps)</p>
<p>City of Portland, OR <i>BES Downspout Disconnection Program</i> CSO reduction in targeted combined sewer sheds. 40%-55% disconnection achieved in many sewer sheds</p>	<p>Direct outreach by door-to-door canvass, direct mail, and community events. Churches, youth and civic groups promote disconnection as a fundraising activity (get a finders fee of \$13 per downspout). 9 AmeriCorps volunteers coordinate program and outreach. City provides free disconnections and gives a \$53 credit per disconnection on sewer bill</p>

Table 1: Case Studies of Rooftop Retrofit Delivery	
Municipal Program	Delivery Mechanisms and Financial Incentives
City of Austin, TX <i>Rainwater Harvesting Programs</i> Water conservation and stream protection	Outreach by utility bill inserts, website, and seminars. Installation is the responsibility of the owner. Rebates for installation (up to \$500 for residential, \$40,000 for commercial). Discounted Rain Barrels (\$60/each; maximum 4). State of Texas sales tax exemption for rainwater harvesting equipment.
Minneapolis, MN <i>Landscaping for Rainwater Management</i> Reduce flooding and improve water quality at the neighborhood scale	Outreach via neighborhood association, website, and workshops. Downspout assessment by specific consultant. Homeowner installation. Subsidized assessment. Matching grants (\$50-\$400) for rain gardens, rain barrels, gutter redirection.
Milwaukee, WI <i>Every Drop Counts</i> CSO reduction and water quality improvement	Outreach by website, newsletters, garden class, and farmers market. Homeowner installation of discounted rain barrels (\$23/each; maximum 5)
Montgomery County, MD <i>Rainscapes</i> Enhance water quality and stream habitat	Outreach by website and workshops. Free “make your own rain barrel” workshops. Homeowner installation
Bremerton, WA http://www.cityofbremerton.com/content/downspoutdisconnections.html Fulton, MN http://www.fultonneighborhood.org/lfrwm.htm Pittsburgh, PA http://www.ninemilerun.org/programs/stewardship/rainbarrel/ Portland, OR http://www.portlandonline.com/bes/index.cfm?c=32144 Austin, TX http://www.ci.austin.tx.us/watercon/default.htm Milwaukee http://www.mmsd.com/programs/every_drop_counts1.cfm Montgomery Co http://www.rainscapes.org	

Rooftop Retrofit Construction Considerations

Construction considerations vary for each rooftop retrofit technique; specific guidance can be found in the rooftop retrofit design sheets provided in Appendix F.

Rooftop Retrofit Costs

The cost to construct rooftop retrofits varies from virtually nothing at all to more than a million dollars per impervious acre treated,

depending on the rooftop retrofit technique employed. Table 2 presents some planning level estimates for the different rooftop retrofit techniques. Appendix F presents more detailed data construction and maintenance costs. Stormwater managers should also account for program administration costs to deliver rooftop retrofits.

**Table 2: Estimated Construction Costs for Rooftop Retrofit Techniques
(2006 \$ per cubic foot treated)**

Rooftop Retrofit Technique	Median Cost	Range	Design & Engineering (%)
Simple Disconnection ¹	\$ 2.00	\$1.00 to \$3.00	5
Rain Barrel ²	\$ 25.00	\$ 12.50 to \$ 40.00	5
French Drain/Drywell ³	\$ 12.00	\$ 10.50 to \$13.50	5
Rain Garden ⁴	\$ 4.00	\$ 3.00 to \$ 5.00	5
Installed Rain Garden ⁵	\$ 10.00	\$ 5.00 to \$ 10.00	32
Bioretention Cell ⁶	\$ 30.00	\$ 25.00 to \$40.00	32
Stormwater Planters ⁷	\$ 27.00	\$ 18.00 to \$36.00	15
Cistern ⁷	\$ 15.00	\$ 6.00 to \$ 25.00	15
Extensive Green Rooftop ⁸	\$225.00	\$ 144.00 to \$300.00	32
Intensive Green Rooftop ⁹	\$360.00	\$300.00 to \$420.00	32

¹ Surface diversion of downspout over appropriate pervious area using flexible pipes
² Average cost for eight cubic foot barrel serving one typical roof leader
³ Three foot deep stone trench serving two roof leaders
⁴ Volunteer homeowner installation (materials cost only with minimal landscaping)
⁵ Residential, but professionally designed/installed with extensive landscaping treatment
⁶ Larger commercial application, treats up to ½ acre of rooftop in existing landscaping area.
⁷ Commercial application, see rooftop retrofit design sheets in
⁸ Commercial rooftop with shallow soil media, see
⁹ Commercial rooftop with deeper soil media and need to structurally reinforce roof

OS-11	On-site Retrofits	
	LITTLE RETROFITS	

Little retrofits are simple on-site practices that treat runoff from directly connected impervious areas less than one acre in size (Figure 1). Examples include sidewalks, bike paths, driveways, basketball and tennis courts, vacant lots, compacted ball fields, paved play areas, and other surfaces that are impermeable to rainfall. Recommended stormwater treatment options for little retrofits include swales, infiltration, filter strips, impervious cover conversion, impervious cover disconnection and soil compost amendments.

Collectively, small impervious areas comprise less than 5% of total impervious area in a subwatershed. So why bother with little retrofits? The reason is that small impervious areas are easy to retrofit because they are isolated within larger pervious areas. Many small impervious areas fall below minimum area thresholds that trigger stormwater management requirement and were therefore built without consideration for engineered drainage or stormwater practice.



Figure 1: Examples of little retrofits serving small impervious areas: a rain garden treating runoff from a trail (a); surface sand filter treating tennis court (b); and bioretention treating a small courtyard (c).

Little retrofits are ideal because they are low cost, require less sophisticated design and can solve localized drainage and erosion problems. In many cases, they can be constructed by watershed groups, homeowners associations or property managers with minimal engineering background.

Ideal Conditions for Little Retrofits

The best conditions for little retrofits are when the retrofit:

- Is located on publicly-owned land such as a park or school
- Would serve an educational or demonstration function

- Is in close proximity to a large pervious area
- Would alleviate an existing drainage or erosion problem
- Can take advantage of soils with a high infiltration rate
- Can be linked with a planned reforestation project for the site (Figure 2)

Other Restoration Alternatives

If a little retrofit doesn't work at a site, reforestation is always a restoration option.

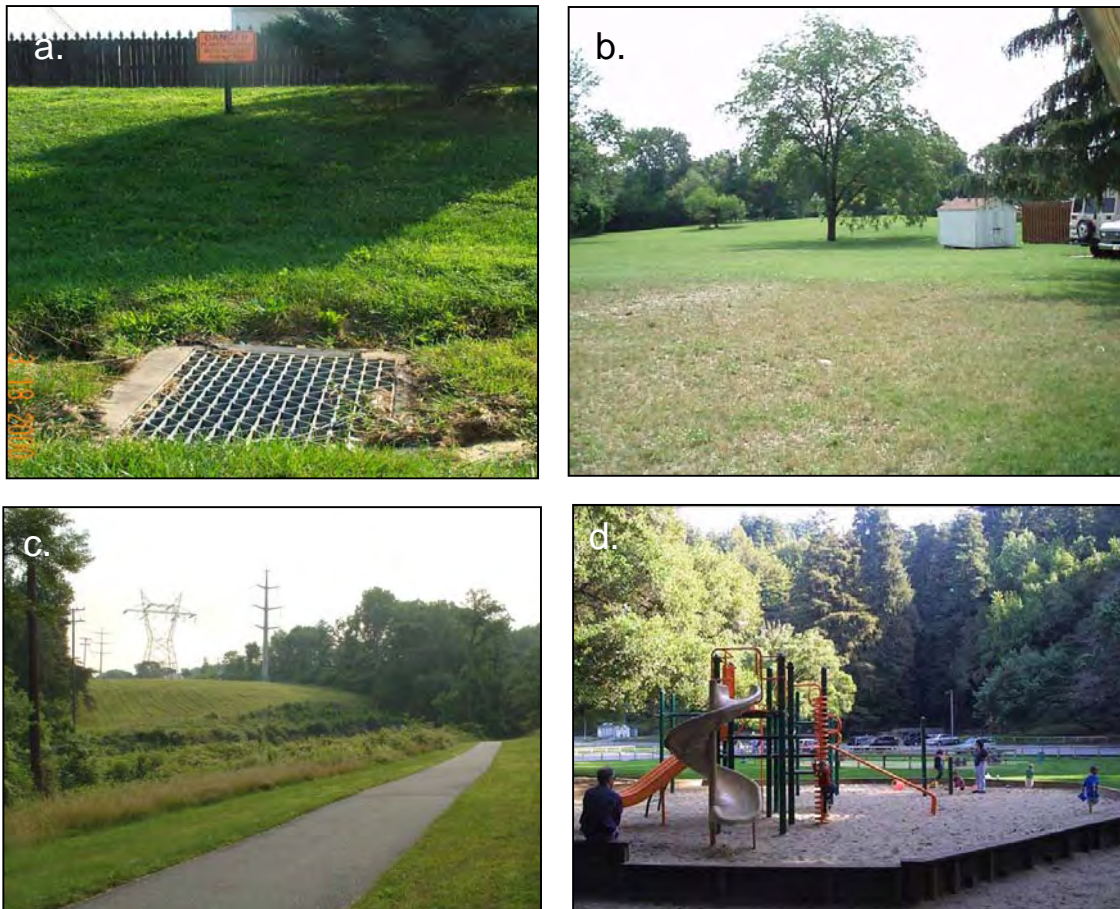

Figure 2: Common areas for little retrofits include pervious areas with drainage problems (a); parks and open space (b); bike trails (c); and playgrounds (d).

Desktop Searching for Little Retrofits

Little retrofits are simply too small to be worth a desktop GIS search or even an analysis of fine resolution aerial photos. They are generally found during field investigations of larger sites. The team may want to look for school properties and tax reverted vacant lots before going out in the field (Figures 3 and 4).

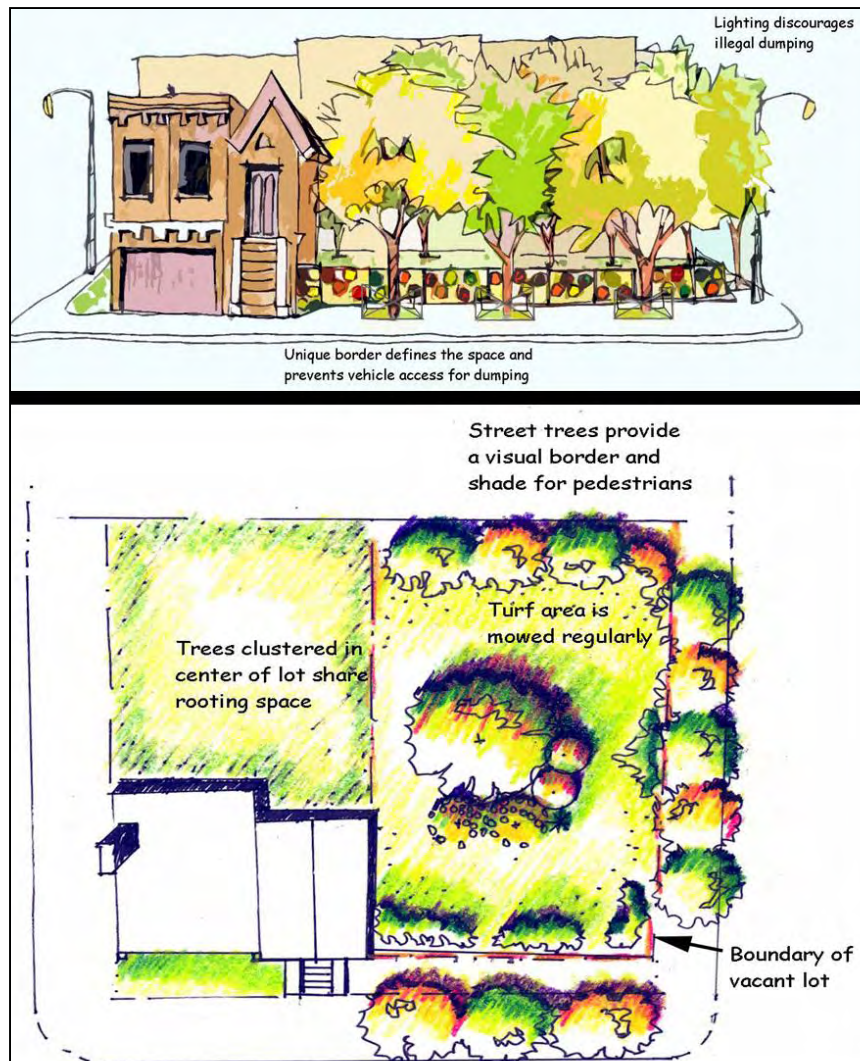
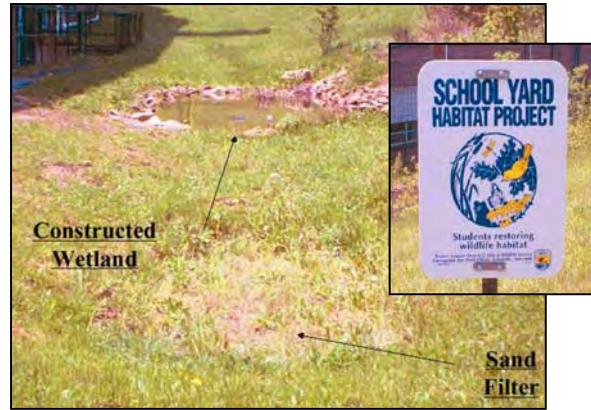

Figure 4: Compost amendments and tree planting are a good little retrofit strategy for vacant lots.

What to Look for During the Investigation

The feasibility of little retrofits is assessed by examining how stormwater works on the site. Crews can diagnose runoff problems by looking for signs of erosion, gullies or sediment deposition in the flow path.

1. The crew should first check to see if the impervious cover is really needed. If not, replace the impervious cover with soil, compost amendments and vegetation.
2. The crew then walks in a down-gradient direction to follow the flow path from the impervious area to the storm drain or channel system
3. If a direct connection exists, find the best place where sheetflow can be split or diverted into a pervious area for treatment. Next, choose the most appropriate and cost-effective stormwater treatment option
4. If no storm drain exists, check to see if runoff flows to an adjacent impervious area.
5. If there is no direct connection to the storm drain system, no retrofit is needed but consider reforestation as an alternative.

Feasibility and Permitting for Little Retrofits

Few environmental permits are needed for little retrofits, although it is a good idea to prepare an erosion and sediment control plan for construction. Landowner approval may need to be secured, although permission is not hard to get if it solves an existing drainage or erosion problem. Most communities will not require a stormwater design plan, although it may be helpful to get technical advice from an engineer or landscape architect. Indeed, little retrofits can be a good opportunity to involve civil

engineering and landscape architecture students from local colleges.

Little Retrofit Design

This class of retrofits is largely sized based on simple design rules and seldom require modeling or engineering to support design (Figure 5). Little retrofits rely on the common-sense knowledge of park managers, site superintendents or watershed group staff.

Soil Investigation - Soil properties often dictate whether or not infiltration will work for a little retrofit. The crew may choose one of the following methods to determine soil infiltration rates:

- Observe how the site responds to rainfall during a storm to see if water ponds or infiltrates and discover the flow path through the site.
- Local cooperative extension offices can provide low cost or free tests to establish soil drainage qualities



Figure 5: While little retrofits require minor engineering, it is advisable to get some technical help.

- A low-tech infiltration test can be performed by digging a hole, filling it with water, and timing how long it takes to disappear. Dig below the topsoil to the proposed ponding depth (e.g., 6 inches). If the water infiltrates in the hole within 24 hours, the site may be suitable for an infiltration practice, although 12 hours or less is preferred.
- A soil auger can bore down below the bottom of the retrofit to determine if clay layers exist that would impede infiltration.

Plant Selection and Layout – To choose the right plants for the little retrofit, it is advisable to consult with a local partner, such as a master gardener, cooperative extension agent, landscape architect, or community forester. Most states also recommend native species. Where possible, ask the plant expert to do an on-site visit. In some cases, soil amendments that incorporate two inches of compost into the top six inches of soil can improve both infiltration and plant survival.

Flow paths - Learning the flow path helps determine the location and the drainage area of a little retrofit. Some simple field observations and measurements can define the flow path and drainage:

- Visit during a rain storm to see where water flows.
- Spray the area with a hose or dump a bucket of water to simulate rain.
- Roll a tennis ball to see which direction it travels over a smooth impervious surface.
- Use two stakes, a string, and a hanging level to measure elevation difference. Pound a stake into the ground or have someone hold it on an impervious surface. Tie the string to each stake, and hang the level on the taut string. Adjust

the string on the stakes until the string is level. Measure from the string to the ground and compare the distances. Use this method to determine the slope of a proposed site.

Sizing - Some simple rules can be applied to size the little retrofit once the location and drainage area are known. For example, the following guidance can be used to disconnect impervious areas over a vegetated filter strip:

- The contributing flow path from impervious cover should not exceed 75 feet.
- The pervious area disconnection length must exceed the contributing flow path. The recommended minimum length over which runoff is spread is 75 feet. Make sure that the runoff cannot “reconnect” by flowing back onto an impervious surface within 75 feet.
- Pervious areas used for disconnection, including swales and filter strips, should have a slope no greater than 5%.
- The total impervious area draining to a single point shall not exceed 1,000 square feet.

Rain gardens and infiltration practices can be sized as a fraction of the impervious surface that drains to them. In general, the surface area of the practice should be about 10 to 20% of the impervious drainage area. Additional guidance on these practices can be found in Appendix F.

Stabilizing the Retrofit Site – Silt fences should be installed for little retrofits that involve more than a few hundred square feet of soil disturbance. Apply grass seed and soil amendments immediately after digging and use a seeding mix that grows well during the season when construction is scheduled.

Little Retrofit Delivery Considerations

The best delivery mechanism for little retrofits is to establish a mini-grant program for local watershed groups, community associations, garden clubs or service organizations who can provide volunteer labor for construction (Figure 6). Local watershed groups or municipal staff can also provide technical assistance to develop little retrofits project plans. Municipal agencies

may want to develop short and simple specifications for little retrofits; excellent examples have been developed by Hoyt and Zielinski (2006). It is also a good idea to install interpretive signs to describe how the little retrofit works (Figure 7).

Little Retrofit Costs

The costs to construct little retrofits are generally quite low, as shown in Table 1.



Figure 6: Example of interpretative signage with a little retrofit.



Figure 7: Little retrofits are a great way to involve volunteers in watershed restoration.

**Table 1: Estimated Construction Costs for Little Retrofits
(2006 \$ /cubic foot treated)**

Retrofit Option	Median Cost	Range	Design & Engineering (%)
IC Conversion ¹	\$ 20.00	\$ 18.50 to 21.50	5
Soil Compost Amendments ²	\$ 8.00	\$ 3.15 to \$11.40	5
Filter Strip ³	\$ 5.00	\$ 3.50 to \$ 10.00	5
Simple Infiltration ⁴	\$ 7.50	\$ 5.00 to \$ 11.50	5
Rain Garden (volunteer) ⁵	\$ 4.00	\$ 3.00 to \$ 5.00	5
Rain Garden (contractor) ⁶	\$ 7.50	\$ 5.00 to \$ 15.00	15
Bioretention ⁷	\$ 10.50	\$ 7.50 to \$ 17.25	32

¹ Demolition and removal of existing concrete or asphalt, and applying topsoil and hydroseed to establish vegetation

² Simple redirection of flow from impervious area to a pervious area using flow spreader, curb cut or checkdam split

³ Deep tilling, mixing of nine inches of compost, and reseeding

⁴ Re-grading, level spreader and reseeding to establish vegetation

⁵ Directing runoff into shallow infiltration trench

⁶ Volunteer installation, materials and equipment rental only

⁷ Professionally installed with more extensive landscaping

⁸ Professionally designed and installed bioretention cell serving more than 0.5 acres of CDA

<h1>OS-12</h1>	On-site Retrofits	
	<h2>LANDSCAPES-HARDSCAPES</h2>	

This class of retrofits relies on landscaping to treat stormwater in highly urban settings. Examples include commercial landscaping areas, plazas, waterfronts, urban streetscapes, and pocket parks (Figure 1). While these urban landscapes occupy a trivial amount of total subwatershed area, they are included here because they represent a great opportunity to demonstrate retrofits in highly visible locations. The basic strategy is to treat stormwater as a landscaping resource and design amenity using innovative practices such as rain gardens, stormwater planters, expanded tree pits or permeable pavers (Figure 2).

Scaping retrofits are ideal because they have strong demonstration and education value,

are frequently maintained, and may lower landscaping maintenance costs through reduced mowing, greater tree survival, or less irrigation.

Ideal Conditions for Scaping Retrofits

- Commercial, municipal, institutional and urban park settings
- Redevelopment and infill projects
- Public spaces with high exposure
- Area where urban water features are being designed as an amenity
- Downtown central business districts
- Waterfront developments
- Development constructed through public/private partnerships
- Neighborhood beautification and revitalization projects

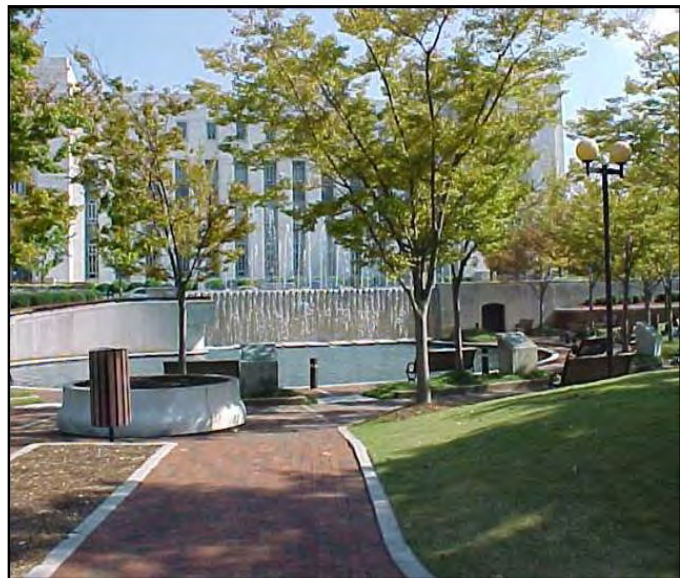



Figure 2: Landscape architects can creatively use stormwater as a resource in foundation planters (a); permeable pavers (b); bioretention (c); and stormwater tree pits (d).

Situations Where Scaping Retrofits Don't Work

- No party is willing to undertake routine maintenance
- Retrofit would need to be shut down in winter to avoid ice problems

Alternative Restoration Practices

Even if a retrofit is not possible, other restoration projects may apply including:

- Reduced fertilizer and pesticide use (see Profile Sheet H-13 in Manual 8)
- Planting native plants
- Urban forestry practices

- Smart Site practices for redevelopment and infill that minimize impervious cover (CWP, 2004a)

Desktop Searching for Scaping Retrofits

A GIS search for scaping retrofits is probably overkill. It is much more effective to work with community planners and urban designers to discover public projects where scaping retrofits could be incorporated into the early planning stage. Local city planners, park designers, landscape architects or arborists may also know about opportunities for scaping retrofits in upcoming projects. They should be encouraged to view

stormwater as a resource and landscaping as a water quality solution.

What to Look for During the Investigation

There really is no field investigation for scaping retrofits. Designers simply participate in the urban design process to look for opportunities to insert scaping retrofits. The following concepts should be kept in mind when designing scaping retrofits:

Hydrology - Keep in mind that scaping retrofits will receive more runoff to the planting area than would otherwise be supplied by rainfall. Designers should compare the surface area delivering runoff to the surface area of the planting area itself. If the ration is more than 5:1, the scaping retrofit should have an underdrain so that plants don't become water logged. If the ratio is greater than 10:1, the design should include a surface overflow.

Plants - The real trick in scaping retrofits is to match the right plant materials to the expected moisture conditions created by the retrofit. Depending on the seasonal rainfall regime, plants may be exposed to long periods of drought followed by short periods of full saturation. At the same time, landscape architects want to select plants that meet their design objectives for form, function and color. Designers may want to consult regional plant and tree lists developed for stormwater or urban forestry that outline their tolerance for inundation, drought, chlorides, shade and other factors (Cappiella *et al.*, 2007).

Soil Media - Scaping retrofits require the creation of special soil media to meet both stormwater and landscaping needs. From a stormwater standpoint, the media should

promote rapid drainage through the bed, but also have a layer of organic material to bind pollutants. A common soil mixture contains 50% sand, 30% non-clayey topsoil, and 20% well-aged compost. From a landscaping perspective, the soil media needs to be dense enough to support trees and shrubs, and retain enough moisture and nutrients to ensure growth during dry periods. The surface of the planting bed is also a key design consideration. Designers may want to use native rock, river stone or bank run gravel to provide a more durable surface than mulch and create a more artistic impression.

Water Features - Scaping retrofits are an opportunity to combine functional landscape treatment with art (Echols and Pennypacker, 2007). The aesthetic possibilities are endless, but frequently involve a cascading flow of water through chutes and ladders, much as it does in a natural stream.

Plaza and Sidewalk Drainage - This approach reduces stormwater runoff by connecting impervious areas with landscaped areas. Permeable pavers or porous concrete can further limit runoff generation from hard surfaces. These pavers come in a variety of textures and patterns, and are durable enough to hold up to pedestrian traffic. Sidewalks and plazas should be sloped toward the landscaping areas.

Rooftop Drainage - External downspouts of buildings can be designed to feed into landscaped areas or foundation planters so rooftop runoff becomes a source of supplemental irrigation. The drop from the roof to the ground can also create mini-waterfalls, drive water wheels and rain chimes, or create a cascade effect.

Expanded Tree Pits - Expanded street tree pits capture and treat stormwater and provide better growing conditions for street trees (Figure 3 and Cappiella *et al.*, 2006a). The basic design provides additional root volume for individual trees and links the soil media so that trees can share root volume. Runoff is graded into the pits through curb cuts or grate inlets and an underdrain ties into the existing storm drain system to promote rapid drainage. Pollutant removal is achieved by filtering through the soil media. A plan and profile view of the expanded tree pit design is illustrated in Figures 4 and 5. The expanded tree pit design was originally developed for urban street trees, but can be adapted for any situation where trees are desired in an urban hardscape.



Figure 3: Urban areas are a harsh environment and trees often get too little or too much runoff.

Feasibility and Permitting of Scaping Retrofits

No major permits and approvals are needed for scaping retrofits, beyond those required for the larger construction project of which they are a part.

Scaping Retrofit Design

Urban landscapes are intensely used and require frequent maintenance, so designers may want to consider the following design elements:

- *Heavy pedestrian traffic* – Scaping retrofits should include a barrier to pedestrian entry to prevent soil compaction and plant damage, such as bollards or iron fences.



Figure 4: Urban foresters can treat stormwater using creative street tree planters.

- *Potential vandalism* - Scaping retrofit materials should be durable enough to withstand vandalism.
- *Trash and litter* – Scaping retrofits will collect litter that previously washed into the storm drain system. Designers may need to create a maintenance plan that includes daily or weekly trash clean outs. If the retrofit is located in a public space, maintenance crews will need training on how to access the retrofit to remove trash.

- *Public safety* – Providing adequate lighting and avoiding dense vegetation can address concerns about crime and personal safety
- *Need for supplemental irrigation* – Even plants accustomed the wet/dry cycles of stormwater may require watering for the first year or two to become established.

Scaping Retrofit Delivery Considerations

The primary delivery mechanism is to train landscape architects on water-sensitive design (France, 2003). Education of urban foresters, arborists, urban designers, park managers, maintenance crews and architects can also encourage widespread adoption of scaping retrofits.

Scaping Retrofit Costs

The costs for scaping retrofits depend on the nature of the urban design project. The best way is to generate an initial construction cost estimate is to look at the cost for individual scaping retrofit techniques as shown in Table 1.

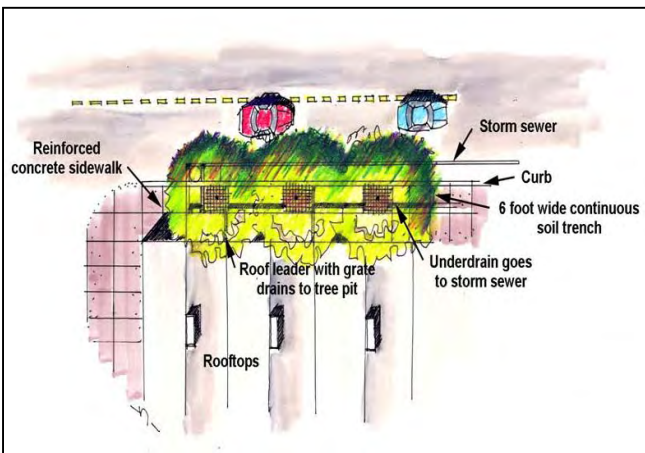
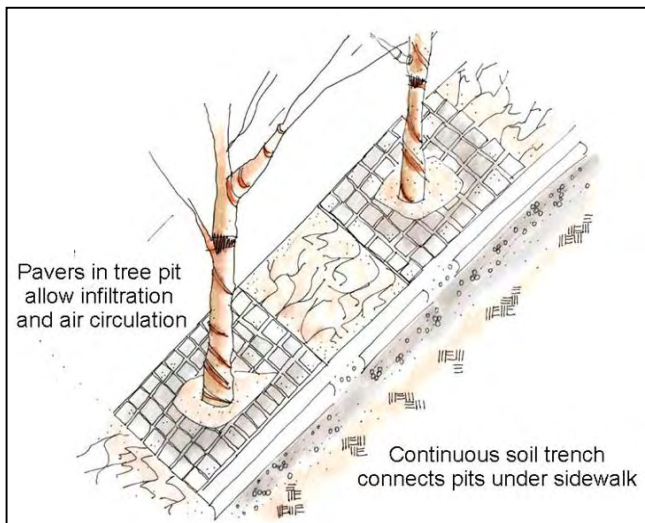
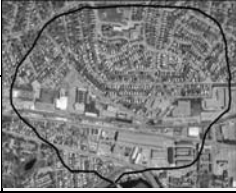

Figure 5: Plan and profile detail on stormwater tree pit design with shared rooting space.

Table 1: Estimated Construction Costs for Scaping Retrofits (2006 \$/cubic foot treated)			
Stormwater Treatment Option	Median Cost	Range	Design & Engineering (%)
Small Bioretention ¹	\$ 30.00	\$ 25.00 to \$ 40.00	32
Permeable Pavers ²	\$ 120.00	\$ 96.00 to \$ 144.00	32
Stormwater Planters ³	\$ 27.00	\$ 18.00 to \$ 36.00	32
Water Quality Swale ⁴	\$ 12.50	\$ 7.00 to \$ 22.00	32
Stormwater Tree Pits ⁵	\$ 70.00	\$ 58.00 to \$ 73.00	32
IC Conversion ⁶	\$ 20.00	\$ 18.50 to \$ 21.50	15
¹ Designed bioretention cell in highly urban area serving less than 0.5 acre CDA with a landscape architect doing planting plan ² Replacement pavers for courtyard or plaza with some subgrade preparation ³ Foundation planters capture rooftop runoff in an enclosed landscape box – see Appendix F ⁴ Conversion of existing surface flow path to a more effective water quality swale ⁵ Expanded tree pits with shared rooting space to treat stormwater in highly urban streets ⁶ Breakup and removal of existing impervious area followed by revegetation with turf			

<h1>OS-13</h1>	On-site Retrofits	
	<h2>UNDERGROUND RETROFITS</h2>	

Underground retrofits are the on-site retrofit of last resort due to their high cost. They make sense when other on-site retrofits cannot fit on the surface, or land acquisition costs are too high. Underground retrofits are normally restricted to small sites that generate high pollutant loadings discharging to sensitive waters. Common methods of underground treatment are shown in Figure 1 and include:

- Infiltration galleries
- Underground sand filter
- Underground detention pipes
- Multi-chamber treatment train (MCTT)
- Proprietary stormwater treatment devices

This class of retrofits applies to ultra-urban subwatersheds that lack surface area for stormwater treatment (Figure 2). The most common form of treatment is the underground sand filter which provides effective pollutant removal. Underground sand filters make sense when water quality and public health issues are paramount.

Ideal Conditions for Underground Retrofits

The most ideal situations for underground retrofits are in:

- Ultra-urban areas that lack available space on the surface for treatment
- Redevelopment or infill projects where stormwater treatment requirements are triggered
- Severe stormwater hotspots or central business districts
- Sites where untreated direct stormwater discharges to extremely sensitive waters (e.g., intake for drinking water supply, swimming beaches, harbors, shellfish beds, waterfronts; Figure 3)
- Sites where pretreatment is needed prior to another retrofit
- Regions that have underlying soils with exceptionally good infiltration rates (e.g., glacial till, outwash plains, sandy plains)
- Parking lots that cannot be served by a surface retrofit
- Public works yards where crews can perform frequent maintenance

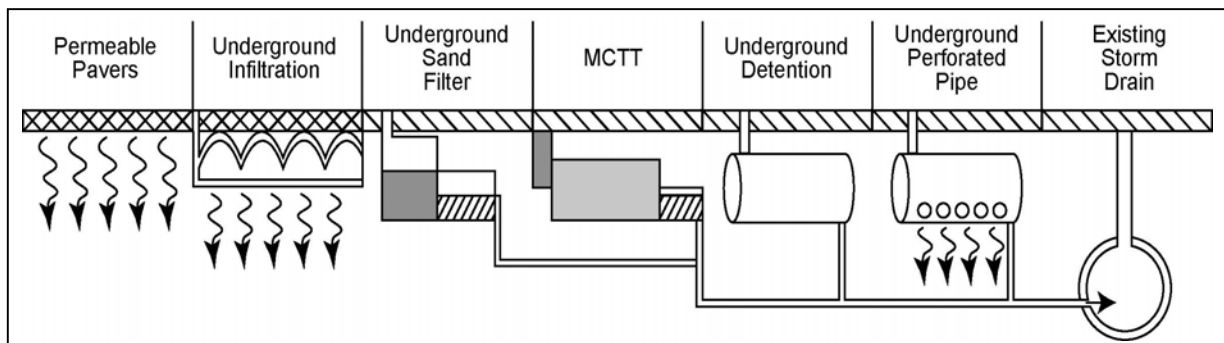

Figure 1: Numerous strategies can be used for underground retrofits.



Figure 2: Underground retrofits are typically used in ultra-urban watersheds that lack surface area for other retrofits.



Figure 3: Large underground sand filter under construction to treat runoff near a drinking water intake.

Situations Where Underground Retrofits Are Difficult

Underground retrofits are problematic when:

- Excavation is limited by bedrock or a high water table
- Multiple utilities run underneath the site
- Terrain is flat and/or adequate head is lacking to drive the retrofit

- The receiving storm drain system is only a few feet below ground level
- Owner/operator is unwilling or unable to frequently maintain it

Restoration Alternatives in Ultra Urban Areas

It can be extremely expensive to retrofit ultra-urban subwatersheds using underground retrofits. Alternatives for improving stormwater quality in these subwatersheds include non-structural practices, such as:

- Intensive street sweeping (Manual 9)
- Regular cleanouts of storm drain inlets (Manual 9)
- Pollution prevention practices (see Manual 8)
- Detection and elimination of illicit discharges (see Brown *et al.*, 2004)
- Municipal housekeeping practices (Manual 9)

Desktop Searching for Underground Retrofits

There is generally no reason to conduct a desktop search to find underground retrofit sites. It may be helpful to consult a soils map to assess potential infiltration rates, but keep in mind that most urban soils are highly altered and compacted due to prior construction and no longer retain their original soil properties.

What to Look for when Investigating Underground Retrofits

Crews should consider underground retrofits only when all other surface retrofit options have been exhausted. Underground retrofits are extremely difficult to assess in the field since it is often hard to understand what is happening underground. The crew should

look for indicators of underground utilities and pop any manholes or grates to determine the invert elevation and diameter of the storm drain pipe that will accept runoff from an underground retrofit.

Feasibility and Permitting for Underground Retrofits

Available head is the primary feasibility factor restricting underground retrofits. The difference in the surface elevation and the pipe elevation defines the head available, which in turn sets the maximum depth of underground treatment. Anywhere from four to 12 feet of head are needed depending on the retrofit design variant.

Underground retrofits require approval by the local stormwater review authority who may lack experience with this class of retrofits. The review and inspection of underground retrofits is more complex than other stormwater practices, and may involve:

- Underground injection permits (if the retrofit infiltrates)
- Confined space safety issues and other OSHA requirements
- Certification that the retrofit is water-tight (if the retrofit does not infiltrate)
- Maintenance contracts to ensure that trapped pollutants are routinely removed

Underground Retrofit Design

Several key design issues are involved in underground retrofits:

To infiltrate or not - The designer should be very clear on the retrofitting objective for the site. If runoff reduction is the goal, infiltration is desirable (Figure 4). On the other hand, filtering is recommended to remove stormwater pollutants to improve

water quality. Infiltration should never be considered at stormwater hotspots to minimize the potential for groundwater contamination. Most urban soils have been severely altered and compacted by past earthmoving, so several borings and infiltration tests are essential for underground retrofits.

Structural reinforcement - Most underground retrofits are installed underneath parking lots and roads, so designers may need to perform a structural analysis to determine whether the retrofit has adequate load bearing capacity or needs structural reinforcement.

Visibility - Underground retrofits are out of sight and out of mind, so designers should include observation wells to monitor retrofit water levels and clearly mark the location of all access points on the ground, in pollution prevention plans and in maintenance records (Figure 5).

Easy sediment removal - Designers should provide multiple access points to maintain the retrofit and carefully think through how crews can safely remove trapped sediments. Designers should look at manhole diameters, grates, ladders and other features to make it



Figure 4: Where soils permit, infiltration galleries can be used to treat stormwater underground.

easy for crews to access the retrofit. It is preferable if sediment removal can be done with specialized equipment such as a vacator truck or hydraulic suction, as opposed to manual removal (Figure 6). Many underground retrofits will require confined space entry training to access the site.

Two cell design - Pretreatment is needed to handle high loads of sediment, trash, and organic debris and to contain spills and transitory illicit discharges. Underground retrofits should have a two cell design. The first pretreatment cell can be wet or dry, and should comprise at least 25% of the target WQv.

Use of proprietary treatment devices - The cost and complexity of underground retrofits can be reduced when proprietary stormwater treatment practices are specified. Designers, however, should clearly understand the capabilities and limitations of these practices when it comes to actual pollutant removal.



Figure 5: Out of sight means out of mind – make sure inspectors can access underground retrofits.

Construction Considerations for Underground Retrofits

Underground retrofits involve several unique construction considerations:

- Worker safety is important during excavation or trenching, particularly if the retrofit will be more than four feet deep.
- Workers should be trained in confined space entry procedures.
- Designers should be present when contractors are pouring concrete and should carefully inspect all work since it is not easy to remedy problems once the retrofit is paved over.
- Inspectors should make sure underground retrofits are water tight unless they are expected to infiltrate stormwater.
- Inspectors should make sure the connection to the accepting storm drain pipe is at the proper elevation.



Figure 6: Mechanized rather than manual sediment removal is always preferred.

Costs for Underground Retrofits

Underground retrofits normally cost at least an order of magnitude more to construct than surface retrofits (Table 1). The higher cost is attributed to:

- Greater need for excavation and off-site hauling
- Underground storage materials
- Structural reinforcement to bear traffic loads

- Poor urban soils
- Need to provide excellent maintenance access
- Cast-in-place construction

In addition, underground retrofits tend to be more expensive to maintain. The cost differential for underground retrofits can narrow if land acquisition is needed for surface retrofits, or if effective proprietary stormwater practices are employed.

Table 1: Estimated Construction Costs for Underground Retrofits (2006 \$ /cubic foot treated)			
Stormwater Treatment Option	Median Cost	Range	Design & Engineering (%)
Underground Infiltration ¹	\$ 180.00	\$ 144.00 to \$ 216.00	32
Underground Sand Filter ²	\$ 65.00	\$ 28.00 to \$ 75.00	32
Multi-Chamber Treatment Train	\$ 80.00	\$ 66.00 to \$ 94.00	32
Porous Concrete ³	\$ 65.00	\$ 50.00 to \$ 85.00	32
Proprietary Practices	\$ 5.00	\$ 3.00 to \$ 20.00	15
¹ Removal of existing impervious cover, 12 inch stone subgrade or plastic arches and installation of pervious surface (permeable pavers, porous asphalt/concrete) ² Two cell underground watertight concrete vault with sand filter ³ Removal of existing impervious cover, six inch stone and typical porous concrete application			

Chapter 3: Stormwater Treatment Options For Retrofitting

Retrofitting involves choosing the most appropriate and effective stormwater treatment option at the individual retrofit site that can achieve local restoration objectives. Designers can choose from among as many as eight different stormwater treatment options when retrofitting (Figure 3.1). Each stormwater treatment option differs greatly in its pollutant removal capability, stormwater benefits and retrofit suitability. In many cases, more than one stormwater treatment option can be used at a retrofit site. This chapter provides general guidance to help designers choose the best options for their particular retrofit situation.

This chapter is not intended to be a treatise on stormwater design, as many stormwater design manuals already exist. Rather, it

outlines how each stormwater option is modified in the context of retrofitting.

The ensuing series of profile sheets describes how each stormwater option can be adapted for retrofitting, and are organized as follows:

- **How They Operate** - How does the stormwater treatment option work to improve the quality of stormwater runoff?
- **Typical Retrofit Applications** - Which retrofit locations in a subwatershed are best for using the stormwater treatment options?

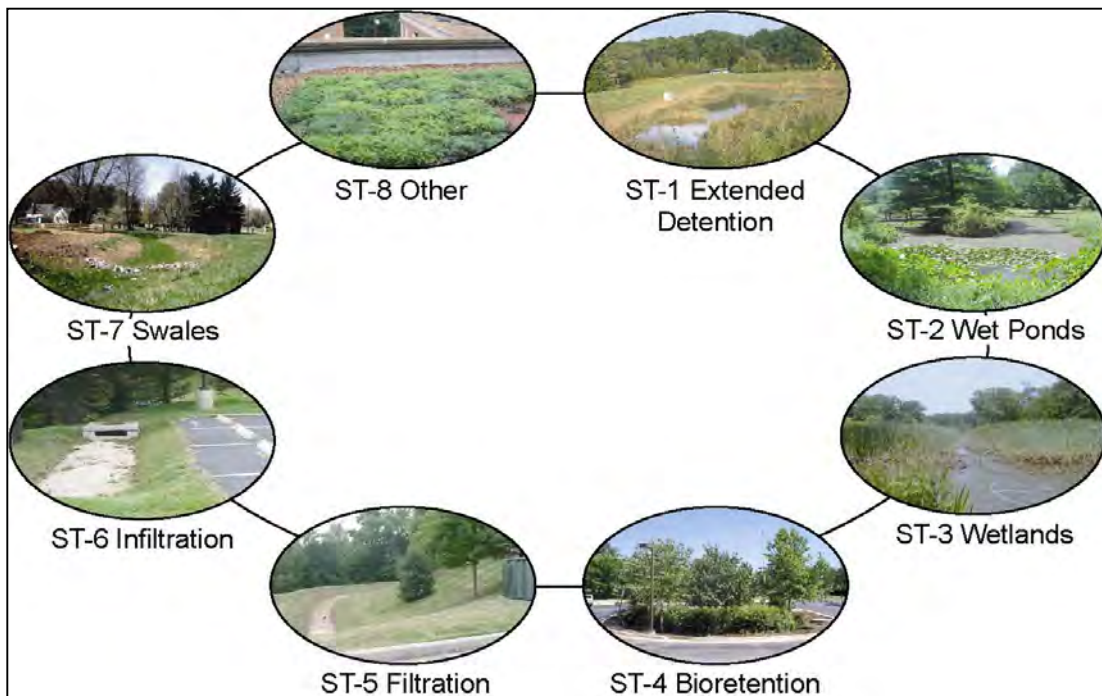

Figure 3.1: Eight stormwater treatment options are available for retrofitting.

- **Pollutant Removal Capability** - What are the primary pollutant removal mechanism(s) and the expected pollutant removal rates for each stormwater treatment options?
- **Other Stormwater Benefits Provided** – Can the stormwater treatment options provide additional stormwater management objectives such as groundwater recharge or channel protection?

Several matrices are provided to help designers choose the most appropriate stormwater treatment option for their retrofit site (Tables 3.1 to 3.3). The first matrix indicates which stormwater treatment options are preferred at each retrofit location, the second compares their ability to meet various restoration objectives, and the last rates their capability to remove different pollutants of concern.

These profile sheets can be used in conjunction with the retrofit location profile sheets contained in Chapter 3 to build a retrofit concept at a given site.

Designers may also wish to consult Appendix I to learn more about how each stormwater treatment option can be adapted for retrofitting. Each design sheet provides further information on the following topics:

- Typical Feasibility Constraints in Developed Watersheds
- Common Community and Environmental Concerns
- Retrofit Design Issues
- Retrofit Maintenance Issues
- Adaptations for Special Climates and Terrain
- Installation Costs
- Internet Design Resources

Table 3.1: Stormwater Treatment Options Used in Different Retrofit Locations								
Subwatershed Location	Stormwater Treatment Option							
	ST-1 Extended Detention	ST-2 Wet ponds	ST-3 Wetlands	ST-4 Bio-retention	ST-5 Filters	ST-6 Infiltration	ST-7 Swales	ST-8 Other
SR-1 Existing Ponds	●	●	●	⊙	⊙	○	○	○
SR-2 Roadway Culverts	●	⊙	●	○	○	○	○	○
SR-3 Below Outfalls	●	●	●	⊙	⊙	○	○	○
SR-4 Conveyance	⊙	○	●	●	○	○	●	○
SR-5 Transport ROW	●	●	●	●	⊙	○	⊙	○
SR-6 Large Parking Lots	●	●	●	⊙	⊙	⊙	○	○
OS-7 Hotspots	○	○	○	●	●	X	○	○
OS-8 Small Parking Lots	○	○	○	●	●	●	●	●
OS-9 Individual Streets	○	○	○	●	⊙	⊙	●	○
OS-10 Rooftops	○	○	○	●	○	⊙	○	●
OS-11 Little Retrofits	○	○	○	●	⊙	●	●	●
OS-12 Hard/Landscape	○	○	⊙	●	⊙	⊙	⊙	●
OS-13 Underground	⊙	○	○	⊙	●	⊙	○	○
<p>KEY</p> <p>● = Preferred stormwater treatment option</p> <p>⊙ = Feasible in some circumstances</p> <p>○ = Seldom used for the retrofit</p> <p>X = Not recommended under any circumstances</p>								

Table 3.2: Ability of Stormwater Treatment Options to Address Retrofit Objectives								
Retrofit Objective	Stormwater Treatment Options							
	Extended Detention	Wet Ponds	Wetlands	Bio-retention	Filtering	Infiltration	Swales	Other
Correct Past Mistakes	●	●	●	●	⊙	●	●	⊙
Reduce Flood Damage	●	●	●	○	○	⊙	○	○
Education/Demonstration	⊙	⊙	●	●	●	●	●	●
Trap Trash and Floatables	●	●	●	⊙	●	○	○	○
Reduce Flows to Combined Sewer	⊙	○	⊙	●	○	●	⊙	●
Renovate Stream Corridor	⊙	●	●	●	○	⊙	⊙	○
Remove Pollutant of Concern	<i>Varies depending on pollutant, see Table 3.3</i>							
Reduce Bank Erosion	●	⊙	⊙	⊙	○	⊙	⊙	⊙
Support Stream Repair	●	⊙	●	⊙	⊙	●	⊙	○
Full Watershed Restoration	●	●	●	●	●	●	●	●

KEY
 ● = Primary stormwater treatment option to address objective
 ⊙ = Secondary stormwater treatment option
 ○ = Supplemental stormwater treatment option

Table 3.3: Comparison of Pollutant Removal Capability							
Stormwater Treatment Option	Stormwater Pollutant						
	TSS	TP	TN	Metals	Bacteria	Organic Carbon	Oil & Grease
Extended Detention	⊙	X	○	○	○	X	⊙
Wet Ponds	●	⊙	○	⊙	⊙	○	⊙
Wetlands	⊙	⊙	○	○	⊙	X	●
Bioretention	⊙	X	○	●	●	⊙	●
Filtering	●	⊙	○	⊙	⊙	⊙	●
Infiltration	●	⊙	○	●	?	●	●
Swales	●	X	○	⊙	X	⊙	●
Rooftop	<i>Varies</i>						

KEY
 ● = Excellent Removal (76 to 100%)
 ⊙ = Good Removal (51 to 75%)
 ○ = Fair Removal (26 to 51%)
 X = Low Removal (0 to 25%)
 ? = Unknown Removal

NOTES
 See Profile Sheets in Chapter 2 for precise removal rates and ranges and Appendix B for documentation on derivation of removal rates

ST-1	Stormwater Treatment Options	
	EXTENDED DETENTION	

This option relies on 12 to 24 hour detention of stormwater runoff after each rain event. An under-sized outlet structure restricts stormwater flow so it backs up and is stored within a pond or wetland. The temporary ponding enables particulate pollutants to settle out and reduces the effective shear stress on downstream banks. Extended Detention (ED) differs from stormwater detention, which is used for peak discharge or flood control purposes and often detains flows for just a few minutes or hours. ED is normally combined with other stormwater treatment options such as wet ponds and constructed wetlands to enhance retrofit performance and appearance (Figure 1). The most common design variations for ED retrofits include:

- Micropool Extended Detention (Water Quality)
- Micropool Extended Detention (Channel Protection)

- Wet Extended Detention Pond
- ED Wetlands

Schematics of each ED retrofit design variation are provided in Figure 2. ED is an ideal stormwater treatment option because it is cost-effective, versatile and safe, and is also the preferred stormwater treatment option for providing downstream channel protection.

Typical ED Retrofit Applications

ED is an attractive option to retrofit existing ponds (SR-1), and can also be utilized for other storage retrofits with the possible exception of the conveyance system (SR-4). ED is generally not suited for on-site retrofit applications. Dry ED ponds should seldom be considered as a standalone retrofit strategy, unless downstream channel protection is a priority.



Figure 1: This shallow wetland was designed with extended detention. (Rolling Stone retrofit, Montgomery County, MD)

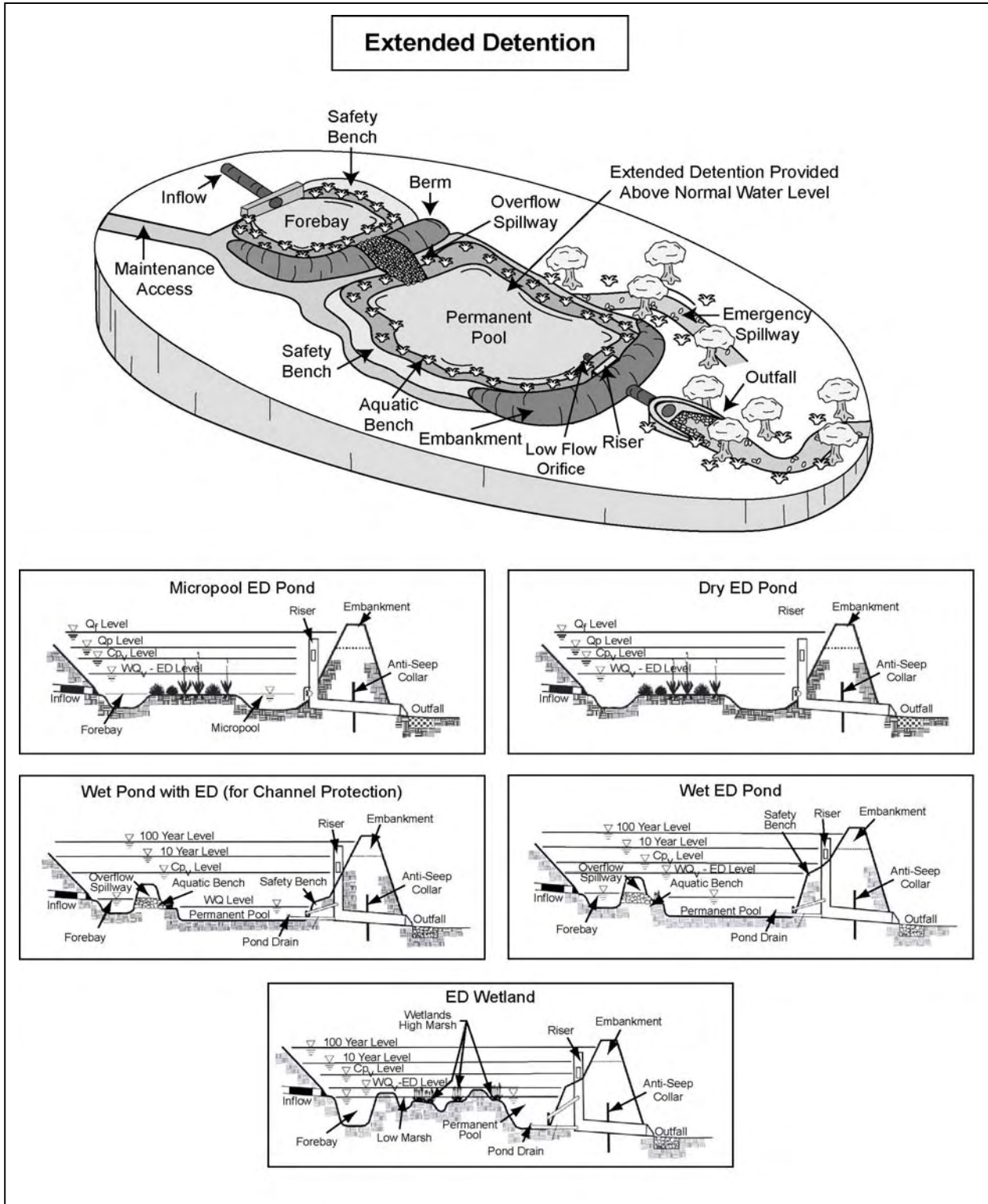

Figure 2: Extended Detention Schematics

ED Pollutant Removal Capability

ED ponds rely on gravitational settling as their primary pollutant removal mechanism. Consequently, they generally provide fair to good removal for particulate pollutants but low or negligible removal for soluble pollutants, such as nitrate and soluble phosphorus (Table 1). ED generally has the lowest overall pollutant removal rate of any stormwater treatment option. As a result, ED

is normally combined with wet ponds or constructed wetlands to maximize pollutant removal rates.

Several site-specific factors can have a strong influence on ED pollutant removal rates. Designers should review the design factors in Table 2 to compute the expected pollutant removal rates for the individual retrofit using the design point method.

Table 1: Range of Reported Removal Rates for Dry Extended Detention Ponds			
Pollutant	Low End	Median	High End
Total Suspended Solids	50	70	80
Total Phosphorus	15	20	30
Soluble Phosphorus	-10	-10	40
Total Nitrogen	25	25	35
Organic Carbon	15	25	35
Total Zinc	25	30	60
Total Copper	30	30	50
Bacteria	0	40	90
Hydrocarbons	40	70	80
Chloride	0	0	0
Trash/Debris	65	80	85
See Appendix D for data sources and assumptions used to derive these removal rates Low End and High End are the 25 th and 75 th quartiles			

Table 2: Design Point Calculation to Estimate Pollutant Removal for ED Retrofits		
Design Factors	X	Points
Wet ED or Multiple Cell Design		+ 2
Exceeds target WQv by more than 25%		+ 1
Exceeds target WQv by more than 50%		+ 2
Off-line design		+ 1
Flow path greater than 1.5 to 1		+ 1
Sediment forebay		+ 1
Constructed wetland elements included in design		+ 1
On-line design		- 1
Flow path less than 1:1		- 1
Pond SA/CDA ratio less than 2%		- 2
Does not provide full WQv volume		- 2
Pond intersects with groundwater		- 2
NET DESIGN SCORE (max. of 5 points)		

An important factor influencing pollutant removal rates is whether ED is combined with another treatment option, such as a wet pond or stormwater wetland. As a general rule, if more than 50% of the target WQv is provided by a wet pond or constructed wetland, then the higher pollutant removal rate for the treatment option should be applied (see Profile Sheets ST-2 and ST-3).

Other Stormwater Benefits Provided by ED

ED retrofits can provide other stormwater benefits to address other restoration objectives:

Recharge: Dry ED pond retrofits can provide modest groundwater recharge benefits. Strecker *et al.* (2004) reported up to 30% runoff reduction for a large population of monitored dry ED ponds,

presumably due to infiltration through the bottom soils of the basin. Recharge benefits will be reduced if the ED pond has impermeable or compacted soils, a liner, or a permanent pool of water.

Channel Protection: ED ponds are the primary means to protect downstream channels if full channel protection storage can be provided at the retrofit site. It should be noted, however, that channel protection normally requires about 20-40% more storage volume than that needed for water quality treatment (see Figure 1.3 in Chapter 1). Consequently, designers may have difficulty finding adequate space to retrofit channel protection storage at tight sites. Guidance on estimating channel protection storage volume for individual retrofit sites can be found in Appendix C.

ST-2	Stormwater Treatment Options	
	WET PONDS	

Wet ponds consist of a permanent pool of standing water that promotes a better environment for gravitational settling, biological uptake and microbial activity (Figure 1). Runoff from each new storm enters the pond and partially displaces pool water from previous storms. The pool also acts as a barrier to re-suspension of sediments and other pollutants deposited during prior storms. When sized properly, wet ponds have a residence time that ranges from many days to several weeks, which allows numerous pollutant removal mechanisms to operate.

Wet pond retrofits can be employed in several different design configurations:

- Wet Pond
- Wet ED Pond
- Wet Pond with ED for Channel Protection
- Pond Wetland System

Figure 2 illustrates each wet pond design variation. Wet ponds are an ideal retrofit treatment option due to their high and reliable pollutant removal performance, community acceptance and amenity value. Wet ponds can also provide channel protection above the permanent pool in some retrofit situations.



Figure 1: Wet ponds can provide additional pollutant removal through settling

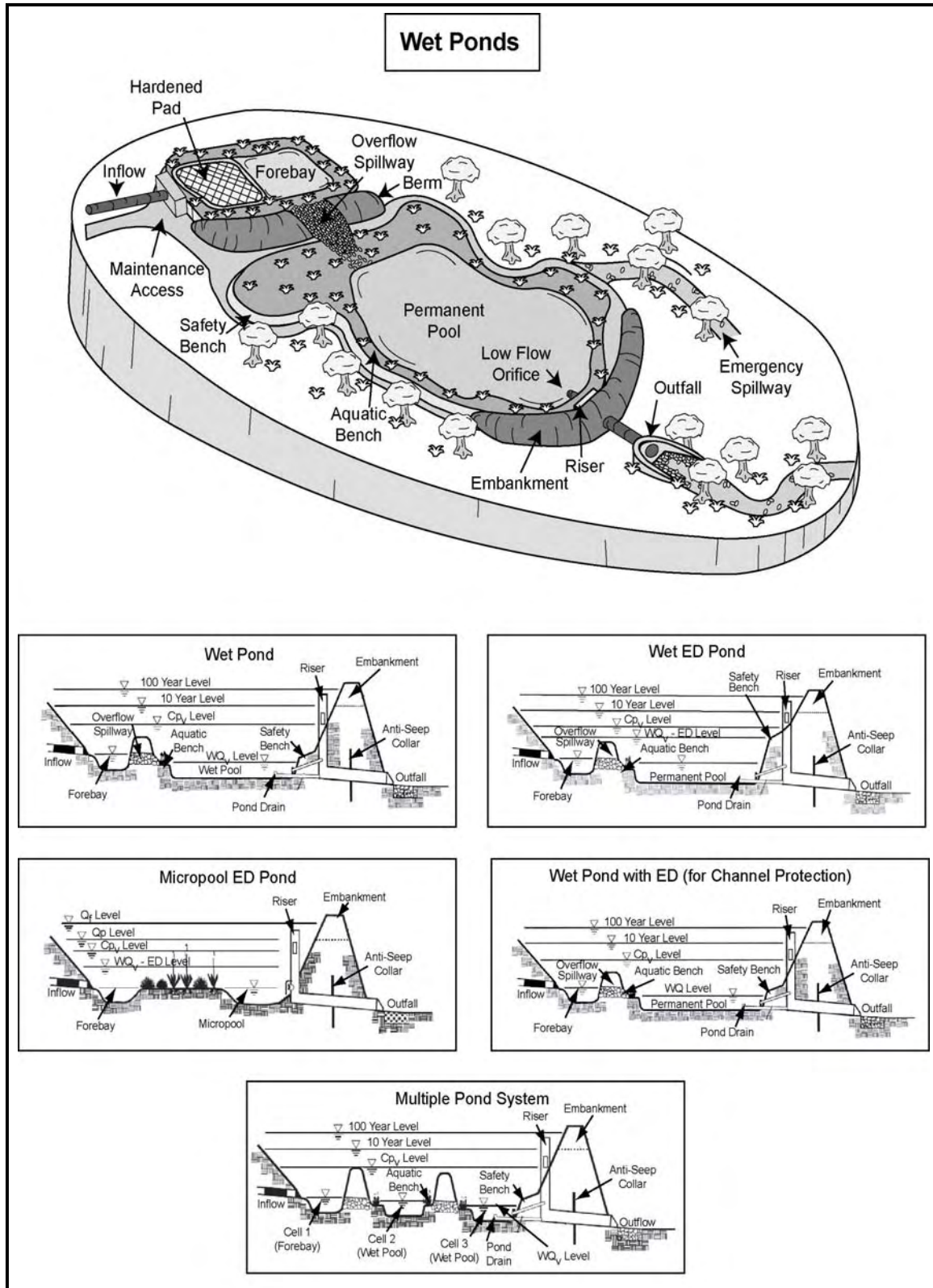

Figure 2: Schematics for various wet pond variations

Typical Retrofit Applications

Wet ponds can be used as either a primary or secondary treatment option in most storage retrofit situations. Wet ponds are not recommended for conveyance retrofits (SR-4) and most on-site retrofit applications.

Wet Pond Pollutant Removal Capability

Many pollutant removal mechanisms operate in the water column and bottom sediments of wet ponds including gravitational settling, algal uptake, adsorption, ultra-violet radiation and microbial processes. Many wet ponds have been intensively monitored in the past three decades and researchers consistently report moderate to high removal rates across the full range of stormwater pollutants (Table 1). Wet ponds generally have higher pollutant removal rates than other stormwater treatment options reviewed in this chapter.

Wet pond research has revealed many site-specific conditions and design factors that can enhance or detract from the median removal rates (Table 2). In general, the walkaway volume of a retrofit is when it cannot provide at least 35% of the target WQv. In addition, if more than 50% of the target water quality volume is provided by ED, the lower removal rates outlined in Profile Sheet ST-1 should be applied. Designers can review the design factors and site conditions in Table 2 to evaluate

whether their individual retrofit design will perform better or worse than normal, using the design point method.

Other Stormwater Benefits Provided by Wet Ponds

Wet pond retrofits have limited potential to provide other stormwater benefits:

Groundwater Recharge: Due to their standing water and sealed bottoms, wet ponds do not offer much benefit in terms of groundwater recharge.

According to Strecker *et al.* (2004), wet ponds reduce incoming runoff volumes by less than 5%, most of which is accomplished by evaporation rather than soil infiltration.

Channel Protection: When site topography permits, extended detention can be stacked above the permanent pool to provide downstream channel protection. Designers should note that the CPv storage is typically 20 to 40% greater than the WQv storage so it is often hard to provide full channel protection at tight retrofit sites. Guidance on estimating the channel protection volume needed at individual retrofit sites can be found in Appendix C.

Table 1: Range of Reported Removal Rates for Wet Ponds			
Pollutant	Low End	Median	High End
Total Suspended Solids	60	80	90
Total Phosphorus	40	50	75
Soluble Phosphorus	40	65	75
Total Nitrogen	15	30	40
Organic Carbon	25	45	65
Total Zinc	40	65	70
Total Copper	45	60	75
Bacteria	50	70	95
Hydrocarbons	60	80	90
Chloride	0	0	0
Trash/Debris	75	90	95
See Appendix D for data sources and assumptions used to derive these removal rates Low End and High End are the 25 th and 75 th quartiles			

Table 2: Design Point Calculation to Estimate Pollutant Removal for Wet Pond Retrofits		
Design Factors	X	Points
Wet ED or Multiple Pond Design		+ 2
Exceeds target WQv by more than 50%		+ 2
Exceeds target WQv by more than 25%		+ 1
Off-line design		+ 1
Flow path greater than 1.5 to 1		+ 1
Sediment forebay at major outfalls		+ 1
Wetland elements cover at least 10% of surface area		+ 1
Single cell pond		- 1
Flow path less than 1:1		- 1
On-line design		- 1
Pond SA/CDA ratio less than 2%		- 2
Does not provide full WQv volume		- 2
Pond intersects with groundwater		- 2
NET DESIGN SCORE (max of 5 points)		

ST-3	Stormwater Treatment Options	
	CONSTRUCTED WETLANDS	

How Constructed Wetlands Work

Constructed wetlands are shallow depressions that receive stormwater inputs for treatment. Wetlands are typically less than one foot deep (although they have deeper pools at the forebay and micropool) and possess variable microtopography to promote dense and diverse wetland cover (Figure 1). Runoff from each new storm displaces runoff from previous storms, and the long residence time allows multiple pollutant removal processes to operate. The wetland environment provides an ideal environment for gravitational settling, biological uptake, and microbial activity.

Constructed wetlands can be a stand-alone treatment option, or be combined with other stormwater treatment options in several configurations:

- Shallow Marsh
- ED Wetland
- Pond Wetland
- Wet Swales

Each constructed wetland design variation is illustrated in Figure 2.

Constructed wetlands are ideal because they replicate natural wetland ecosystems, provide efficient and reliable pollutant removal and have low construction costs (if ample space is available at the retrofit site). Well-designed stormwater wetlands enjoy widespread community acceptance, and possess high amenity and habitat value. Depending on site topography, constructed wetlands can also provide downstream channel protection when ED storage is stacked above the normal water level of the wetland.



Figure 1: This wetland was constructed to treat stormwater from a nearby commercial area.

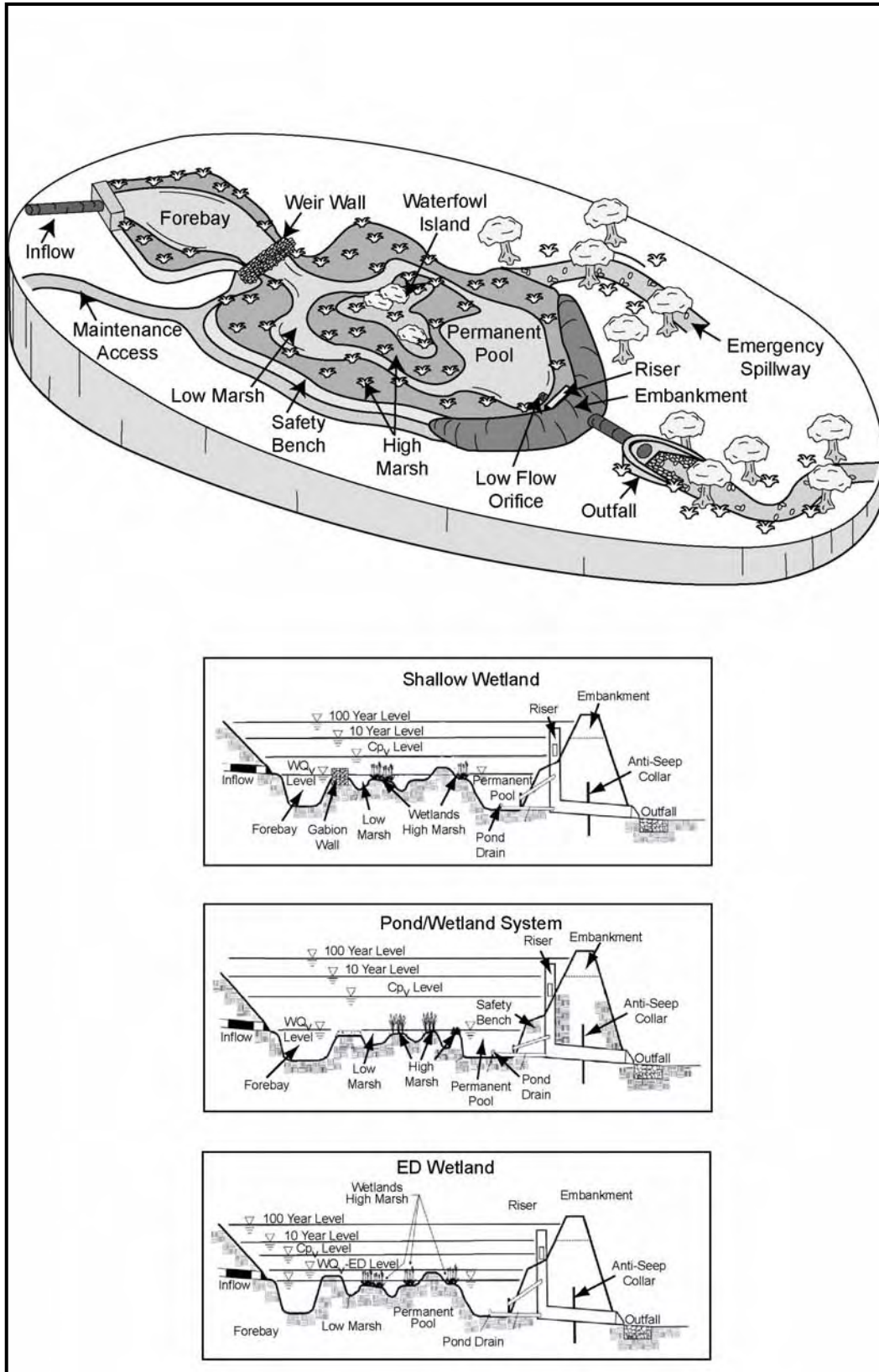

Figure 2: Schematics of three wetland variations

Typical Retrofit Applications for Constructed Wetlands

Constructed wetlands can be the primary or secondary form of stormwater treatment in the following storage retrofit applications:

- **SR-1** Excavate shallow wetland in bottom of pond or add aquatic benches to wet pond
- **SR-2** Create wooded wetlands above road crossings (often with ED)
- **SR-3** Divert runoff from pipe to shallow wetland treatment cells in floodplain
- **SR-4** Install offline shallow wetland cells or in-line wet swales in the conveyance system
- **SR-5** Install wetland cells in highway cloverleaf or create wet swales in highway right of way
- **SR-6** Create wetland treatment cell adjacent to large parking lots

Constructed wetlands are seldom used for on-site retrofit applications, although several may incorporate some wetland elements.

Pollutant Removal Capability of Constructed Wetlands

Constructed wetlands utilize a range of physical, chemical, microbial and biological mechanisms to remove pollutants. Wetland vegetation and sediments provide a growth media for microbes and filter and settle pollutants attached to sediments.

Researchers have studied a large population of stormwater wetlands, and have concluded their removal rates are similar to wet ponds, but are somewhat more variable, especially for nutrients and organic carbon (Table 1).

Key design factors and site conditions that increase or decrease pollutant removal rates within constructed wetland retrofits are outlined in Table 2. The recommended walkaway volume for wetland retrofits is when they provide less than 35% of the target WQv. Constructed wetlands that allocate more than 50% of their storage for ED should use the lower removal rates for ED ponds shown in Profile Sheet ST-1. The median pollutant removal rates at individual retrofit sites can be adjusted to account for runoff capture volume and other site factors using the design point method (Table 2).

Other Stormwater Benefits Provided by Constructed Wetlands

Constructed wetlands can offer additional stormwater benefits:

Runoff Reduction: Constructed wetlands are capable of reducing 5 to 10% of the incoming runoff volume through evaporation and seepage losses, according to Strecker *et al* (2004). This minor reduction is not likely to provide a meaningful groundwater recharge benefit.

Channel Protection: Designers can stack ED above constructed wetlands to provide channel protection storage, although the frequent changes in water levels will degrade the quality and density of wetland cover. Designers can avoid the “bounce” problem by limiting the vertical depth of extended detention. Guidance on estimating the channel protection volume needed at an individual retrofit site is provided in Appendix C.

Table 1: Range of Reported Removal Rates for Constructed Wetlands			
Pollutant	Low End	Median	High End
Total Suspended Solids	45	70	85
Total Phosphorus	15	50	75
Soluble Phosphorus	5	25	55
Total Nitrogen	0	25	55
Organic Carbon	0	20	45
Total Zinc	30	40	70
Total Copper	20	50	65
Bacteria	40	60	85
Hydrocarbons	50	75	90
Chloride	0	0	0
Trash/Debris	75	90	95
See Appendix D for data sources and assumptions used to derive these removal rates Low End and High End are the 25 th and 75 th quartiles			

Table 2: Design Point Calculation to Estimate Pollutant Removal for Wetland Retrofits		
Design Factors	X	Points
Pond-Wetland or Multiple Cell Design		+ 2
Pond-Wetland or Multiple Cell Design		+ 2
Exceeds target WQv by more than 50%		+ 2
Complex wetland microtopography		+ 2
Exceeds target WQv by more than 25%		+ 1
Flow path greater than 1.5 to 1		+ 1
Wooded wetland design		+ 1
Off-line design		+ 1
No forebay or pretreatment features		- 1
Wetland intersects with groundwater		- 1
Flow path is less than 1:1		- 1
No wetland planting plan specified		- 2
Wetland SA to CDA ratio is less than 1.5%		- 2
Does not provide full WQv volume		- 2
NET DESIGN SCORE (max of 5 points)		

ST-4	Stormwater Treatment Options	
	BIORETENTION	

Bioretention is a landscaping feature adapted to treat stormwater runoff at retrofit sites (Figure 1). Individual bioretention areas serve drainage areas of one acre or less. Surface runoff is directed into a shallow landscaped depression that incorporates many of the pollutant removal mechanisms that operate in forested ecosystems. The filter is composed of an 18 to 48 inch deep sand/soil bed with a surface mulch layer. During storms, runoff temporarily ponds six to nine inches above the mulch layer and then rapidly filters through the bed. Normally, the filtered runoff is collected in an underdrain and returned to the storm drain system (Figure 2). The underdrain consists of a perforated

pipe in a gravel jacket installed along the bottom of the filter bed.

In other cases, bioretention can be designed to infiltrate runoff into native soils. This can occur at sites with highly permeable soils, a low groundwater table, and a low risk of groundwater contamination. This design features the use of a “partial exfiltration” system that promotes greater groundwater recharge. Underdrains are only installed beneath a portion of the filter bed or are eliminated altogether, thereby increasing stormwater infiltration.



Figure 1: Bioretention created in a parking lot turn-around

Bioretention creates an ideal environment for filtration, biological uptake, and microbial activity, and provides moderate to high pollutant removal. Bioretention can become an attractive landscaping feature

with high amenity value and community acceptance. In the right landscape setting, bioretention can be a cost effective and flexible retrofit option.

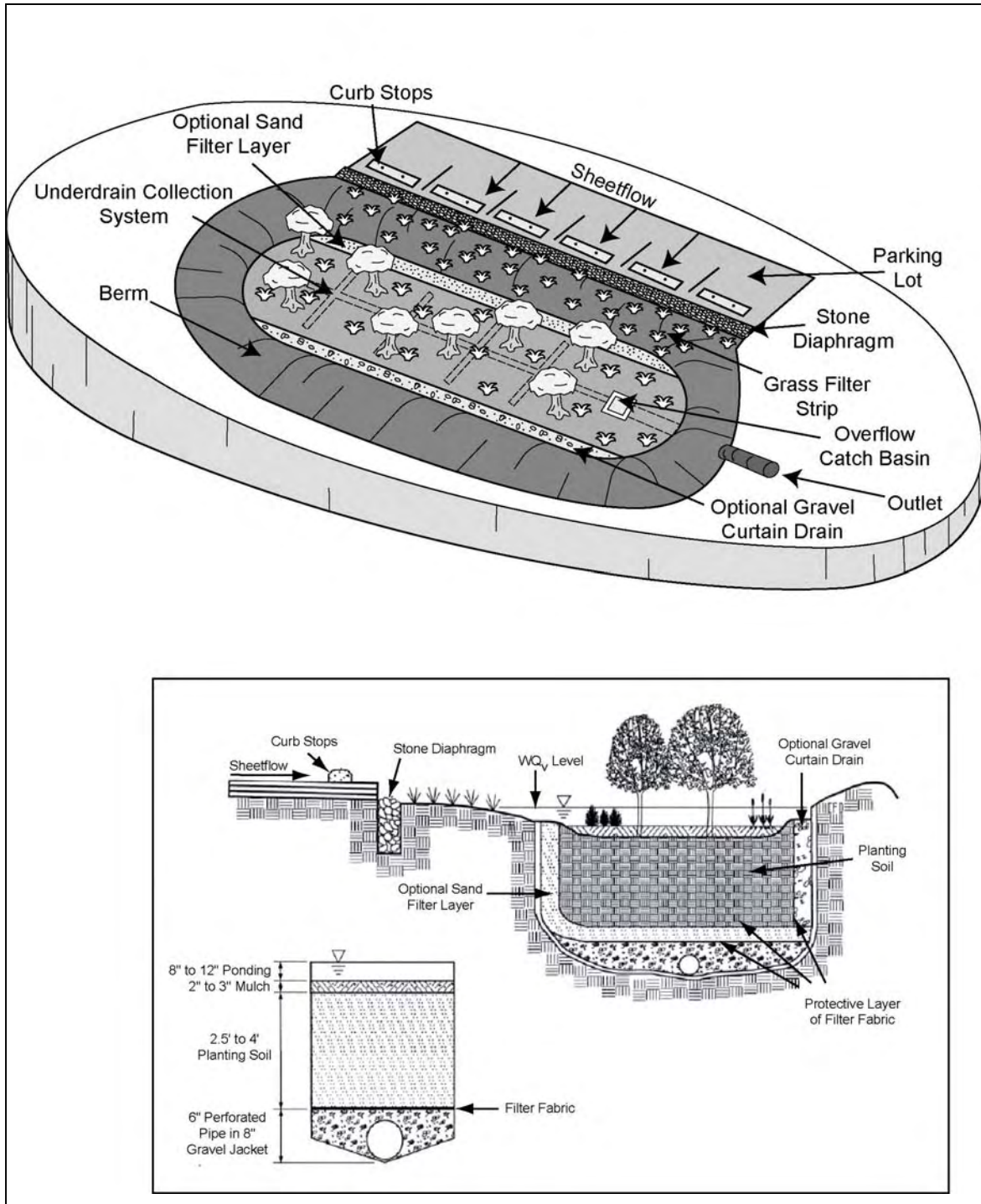

Figure 2: Bioretention schematic with underdrain

Typical Retrofit Applications for Bioretention

Bioretention is an extremely versatile stormwater treatment option for both storage and on-site retrofits that can fit within unused land at a variety of different sites. Common bioretention retrofit opportunities include:

- **SR-1** Install bioretention in bottom of dry pond
- **SR-3** Split flows from smaller pipes to a large bioretention area
- **SR-4** Create series of on-line or off-line bioretention cells
- **SR-5** Install two-cell bioretention area
- **SR-6** Divert flow to two-cell bioretention area
- **OS-7** Install bioretention w/ underdrain to treat hotspot
- **OS-8** Install bioretention within parking lot islands or perimeter
- **OS-9** Incorporate bioretention in streetscapes, tree pits, cul-de-sacs or traffic calming measures
- **OS-10** Install rain-garden to treat residential or commercial rooftop runoff
- **OS-12** Utilize bioretention as a landscape feature

Estimated Pollutant Removal by Bioretention

Until recently, only a handful of monitoring studies had measured the pollutant removal performance of bioretention areas. The most recent studies indicate that bioretention provides effective pollutant removal for many pollutants as a result of sedimentation, filtering, plant uptake, soil adsorption, and microbial processes. Table 1 summarizes bioretention pollutant removal rates for a variety of common stormwater pollutants.

The recommended walkaway volume for bioretention is about 50% of the target water quality volume. Another notable factor is whether the underlying soils have enough permeability to dispense with an underdrain. If an underdrain is not needed, pollutant removal will be enhanced by the greater infiltration of runoff into the soil and may approach the higher pollutant removal rates achieved by infiltration practices (see Profile Sheet ST-6). From the standpoint of nutrient removal, it is strongly recommended that the phosphorus index of topsoil mixed into the bioretention media be tested.

Table 2 can be used to adjust the median removal rates for individual retrofit projects by using the design point method.

Other Stormwater Benefits Provided by Bioretention

Bioretention retrofits can provide important stormwater benefits under certain site conditions.

Recharge: Bioretention has been shown to reduce runoff volume by 35 to 50% through evapotranspiration and infiltration of runoff, according to Hunt *et al.* (2006) and Traver (2006). Runoff reduction exceeding 90% has been reported for deeper filter beds that lack underdrains and are situated on permeable soils (Horner *et al.*, 2003).

Channel Protection: The feasibility of storing the channel protection volume within bioretention areas has not yet been demonstrated, although the impressive runoff reduction rates suggests that widespread use of bioretention could be an effective element of a larger strategy to protect downstream channels from erosion.

Table 1: Range of Reported Removal Rates for Bioretention Areas			
Pollutant	Low End	Median	High End
Total Suspended Solids	15*	60*	75*
Total Phosphorus	-75	5	30
Soluble Phosphorus	-10	0	50
Total Nitrogen	40	45	55
Total Zinc	40	80	95
Total Copper	40	80	100
Bacteria	20	50	80
Hydrocarbons	80	90	95
Chloride	0	0	0
Trash/Debris	80*	90*	95*
* Adequate pretreatment must be provided to reduce sediment loads to bioretention areas or clogging and practice failure may result See Appendix D for data sources and assumptions used to derive these removal rates Low End and High End are the 25 th and 75 th quartiles			

Table 2: Design Point Calculation to Estimate Pollutant Removal for Bioretention Retrofits		
Design Factors	X	Points
Exceeds target WQv by more than 50%		+ 3
Exceeds target WQv by more than 25%		+ 2
Tested filter media soil P Index less than 30 (phosphorus only)		+ 3
Filter bed deeper than 30 inches		+ 1
Two cell design with pretreatment		+ 1
Permeable soils; no underdrain needed		+ 2
Upflow pipe on underdrain		+1
Impermeable soils; underdrain needed		- 1
Filter bed less than 18 inches deep		- 1
Single cell design		- 1
Bioretention cell is less than 5% of CDA		-1
Does not provide full water quality storage volume		- 2
Filter media not tested for P Index (phosphorus only)		- 3
NET DESIGN SCORE (max of 5 points)		
NET PHOSPHORUS SCORE (max of 5 points)		

ST-5	Stormwater Treatment Options	
	FILTRATION	

Stormwater filters are a useful practice to treat stormwater runoff from small, highly impervious sites. Stormwater filters capture, temporarily store, and treat stormwater runoff by passing it through an engineered filter media, collecting it in an underdrain and then returning it back to the storm drain system (Figure 1). The filter consists of two chambers; the first is devoted to settling, and the second serves as a filter bed (with sand or an organic filtering media).

Stormwater filters are a versatile retrofit option that offers moderate pollutant removal performance. They are especially attractive for on-site retrofits where space is limited, because they consume very little surface land and have few site restrictions. Filters are the preferred option to treat runoff from stormwater hotspot sites.

There are several design variations of the basic sand filter that enable designers to retrofit challenging sites or improve pollutant removal rates. The most common design variants include:

- Surface Sand Filters
- Surface Organic Media Filters
- Underground Sand Filters
- Perimeter Sand Filters
- Multi-Chamber Treatment Train (MCTT) Filter

Surface Sand Filter

The surface sand filter is designed with both the filter bed and sediment chamber located at ground level (Figure 2). Surface sand filters are designed off-line so that only the desired WQv is directed to the filter for treatment. The surface sand filter is the least expensive filter option, and has been the most widely used.

Organic Media Filter

Organic media filters are essentially the same as surface filters, with the sand replaced with an organic filtering medium (Figure 3). Two notable examples are the peat/sand filter (Galli, 1990a) and the compost filter system. Organic filters achieve higher pollutant removal for metals and hydrocarbons due to the increased cation exchange capacity of the organic media.



Figure 1: Surface Sand Filter

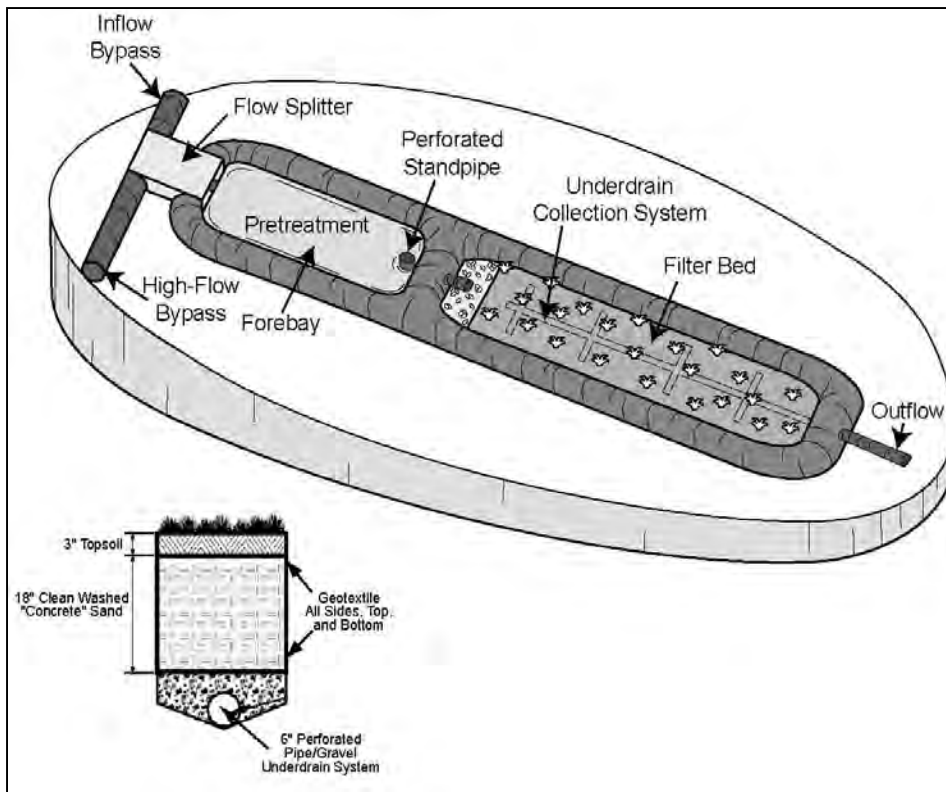

Figure 2: Schematic of a surface sand filter

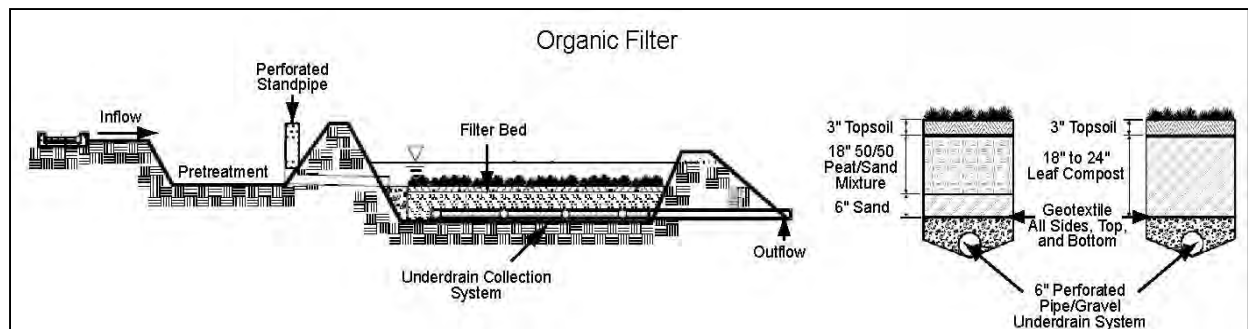

Figure 3: Schematic of an organic filter

Underground Sand Filter

The underground sand filter is modified to install the filtering components underground and is often designed with an internal flow splitter or overflow device that bypasses runoff from larger stormwater events around the filter (Figure 4). Underground sand filters are expensive to construct, but consume very little space and are well suited to ultra-urban areas.

Perimeter Sand Filter

The perimeter sand filter also includes the basic design elements of a sediment chamber and a filter bed. In this design, however, flow enters the system through grates, usually at the edge of a parking lot. The perimeter sand filter is usually located on-line, with all flows entering the system, but larger events bypass treatment by entering an overflow chamber. One major advantage to the perimeter sand filter design

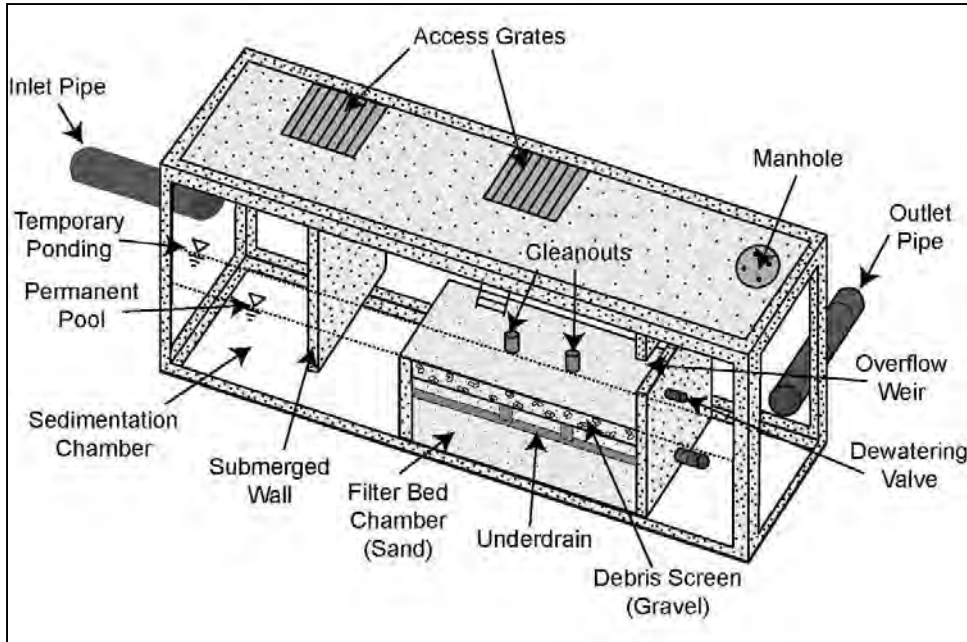

Figure 4: Underground filter schematic

is that it requires little hydraulic head and is therefore a good option for retrofit sites with low relief.

Multi-Chamber Treatment Train (MCTT)

The MCTT is an advanced underground sand filter developed by Pitt *et al.* (1997) that consists of three chambers (Figure 5). Stormwater enters into the first screening chamber where large sediment particles are trapped and highly volatile compounds are removed. The second chamber promotes settling of finer sediments and further removal of volatile compounds and floatable hydrocarbons using fine bubble diffusers and sorbent pads. The final chamber provides filtration using a peat sand filter to remove remaining metals and toxicants. The top of the filter bed is covered by a filter fabric to evenly distribute flow. Monitoring has shown the MCTT can achieve very high pollutant removal rates. Due to its high cost, it is best applied to severe stormwater hotspots.

Typical Retrofit Application for Stormwater Filters

Filter retrofits are particularly well suited to treat runoff from stormwater hotspots and smaller parking lots. Other retrofit opportunities may occur during redevelopment of commercial sites or when existing parking lots are renovated or expanded. While stormwater filters are seldom used as a storage retrofit in humid climates, they may be a more attractive option in arid and semi-arid climates. Some typical retrofit applications for stormwater filters include:

- **SR-3** Split flow from storm drain pipe to a surface sand filter
- **SR-6** Treat flow from large parking lot to a surface sand filter

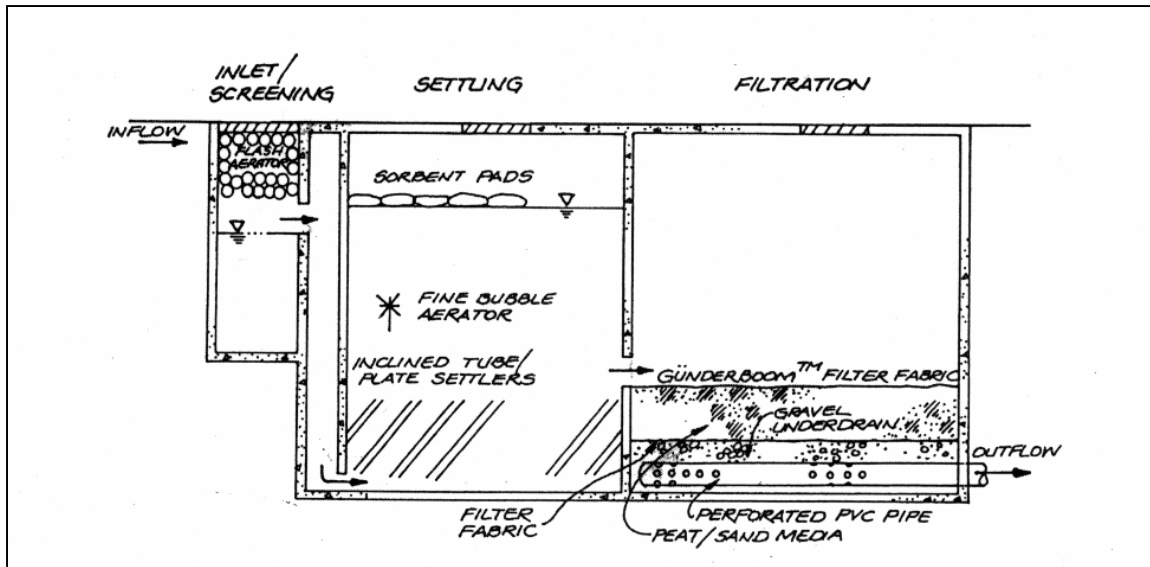

Figure 5: Drawing of a Multi-Chamber Treatment Train

- **OS-7** Treat flow from a hotspot operation using various sand filter designs
- **OS-8** Treat flow from small parking lot using surface or perimeter sand filter
- **OS-13** Treat runoff in an underground sand filter or MCTT

Filters can work on most commercial, industrial, institutional or municipal sites and can be located underground if surface area is not available. Filters are usually designed only for water quality treatment.

Stormwater Filter Pollutant Removal

Stormwater filters depend mainly on physical treatment mechanisms to remove pollutants from stormwater runoff including gravitational settling in the sedimentation chamber, straining at the top of the filter bed, and filtering and adsorption onto the filter media. Microbial films often form on the surface of the filter bed which can also enhance biological removal.

Table 1 reports the range in reported removal rates for 15 sand and organic filters reviewed in the CWP national pollutant removal database (excluding vertical sand filters and the MCTT). As a group, stormwater filters provide consistent removal of most pollutants, with the exception of soluble nutrients, such as soluble phosphorus and nitrate-nitrogen.

Several site-specific conditions and design factors have a strong influence on stormwater filter pollutant removal rates. Table 2 outlines how these factors can be used to adjust median removal rates using the design point method for individual retrofit projects.

If the retrofit is under-sized, pollutant removal rates will be near the lower end of the range. The recommended walkaway volume for stormwater filters is 50% of the target WQv. Another important factor is whether organic material is included in the filter bed media, which can enhance performance with respect to hydrocarbons and metals.

Other Stormwater Benefits Provided by Stormwater Filters

Stormwater filter retrofits can seldom address other stormwater management objectives beyond water quality treatment.

Since they have an impermeable liner and underdrain, they cannot recharge groundwater. They usually lack enough storage capacity to provide meaningful channel protection.

Table 1: Range of Reported Removal Rates for Stormwater Filters			
Pollutant	Low End	Median	High End
Total Suspended Solids	80	85	90
Total Phosphorus	40	60	65
Soluble Phosphorus	-10	5	65
Total Nitrogen	30	30	50
Organic Carbon	40	55	70
Total Zinc	70	90	95
Total Copper	35	40	70
Bacteria	35	40	70
Hydrocarbons	80	85	95
Chloride	0	0	0
Trash/Debris	85*	90*	95*
See Appendix D for data sources and assumptions used to derive these removal rates Low End and High End are the 25 th and 75 th quartiles			

Table 2: Design Point Calculation to Estimate Pollutant Removal for Filtering Retrofits		
Design Factors	X	Points
Exceeds target WQv by more than 50%		+ 3
Exceeds target WQv by more than 25%		+ 2
Site is a severe or confirmed hotspot		+ 2
Organic media used within filter bed (all pollutants except N/P)		+ 2
Two cells with at least 25% WQv allocated to pretreatment		+ 1
Filter bed SA is at least 2.5% of CDA		+ 1
Filter bed exposed to sunlight		+ 1
Off-line design w/ storm bypass		+ 1
Dry pretreatment		- 1
On-line design, w/o storm bypass		- 1
Underground design (except MCTT)		- 1
Filter design is hard to access for maintenance		- 2
Does not provide full WQv volume		- 3
NET DESIGN SCORE (max of 5 points)		

ST-6	Stormwater Treatment Options	
	INFILTRATION	

Infiltration practices capture and temporarily store stormwater runoff before infiltrating it into underlying soils where most pollutants are trapped. Infiltration can be an ideal on-site retrofit to treat stormwater runoff as long as minimum geotechnical requirements are met. Infiltration retrofits consists of a rock-filled chamber with no outlet. Stormwater runoff must first pass through some form of pretreatment, such as a swale or sediment basin. Runoff is then stored in the voids between the stones, where it slowly infiltrates into the soil matrix over a few days (Figure 1). Alternatively,

proprietary materials such as perforated corrugated metal pipe, plastic arch pipe, or plastic lattice trays can be substituted for stone to increase storage capacity. A schematic of a typical infiltration trench is provided in Figure 2.

Where favorable soil conditions exist, infiltration can improve water quality, increase groundwater recharge and reduce runoff volumes. Infiltration practices are particularly desirable in subwatersheds that seek to reduce runoff volumes to prevent combined sewer overflows.



Figure 1: Infiltration Trench

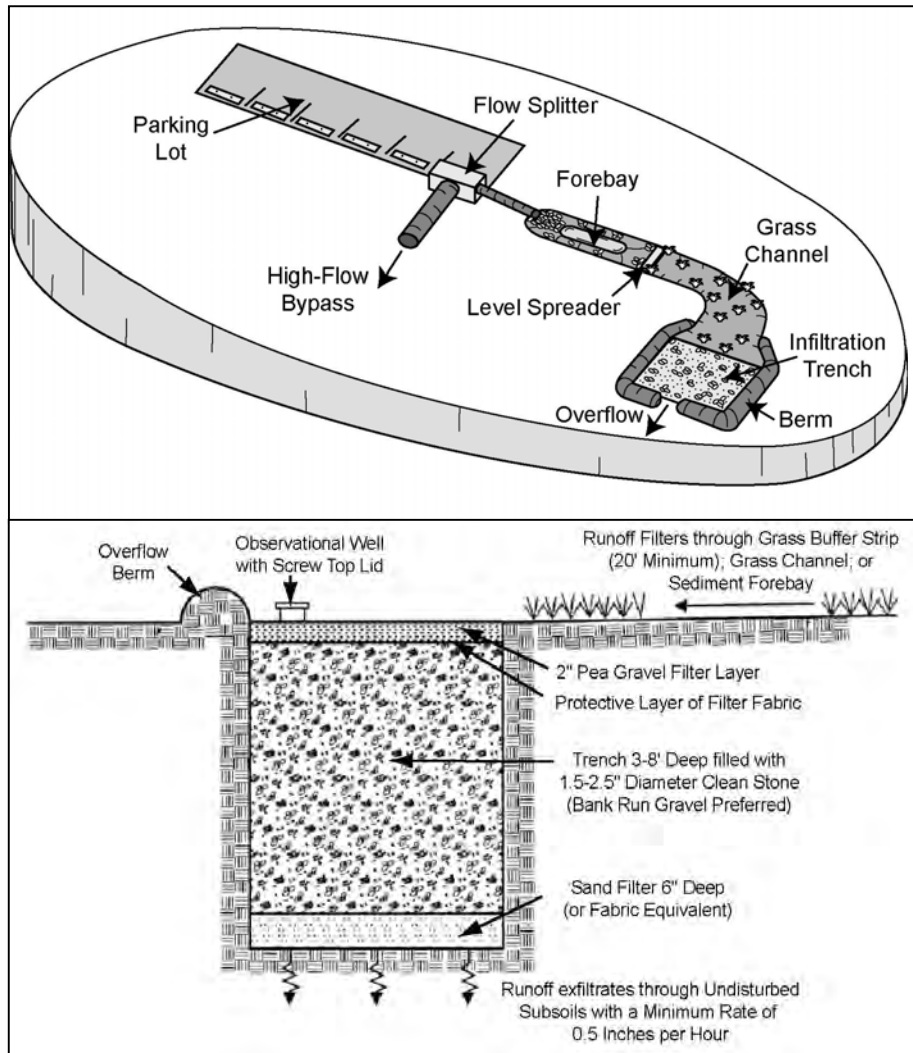

Figure 2: Schematic of an infiltration trench

Other Stormwater Benefits Provided by Stormwater Filters

Stormwater filter retrofits can seldom address other stormwater management objectives beyond water quality treatment. Since they have an impermeable liner and underdrain, they cannot recharge groundwater. They usually lack enough storage capacity to provide meaningful channel protection.

Typical Retrofit Application

Infiltration retrofits can be located on small, unused portions of a site and consume as

little as 2-5% of site area. They are effectively used in narrow linear areas along setbacks or property boundaries. Where soils are acceptable, infiltration can treat runoff in the following retrofit locations:

- **OS-8** Infiltration trenches along margins of small parking lot or use of permeable pavers
- **OS-9** Perforated storm drain pipes to infiltrate street runoff
- **OS-10** Simple disconnection of roof leaders over appropriate soils or use of french drains/dry wells to infiltrate rooftop runoff

- **OS-11** Disconnection of small impervious surfaces
- **OS-12** Permeable pavers in urban hardscapes
- **OS-13** Underground infiltration galleries

Infiltration is seldom used for storage retrofits unless underlying soils have exceptional infiltration capability. It is important to confirm that retrofit soils can support adequate infiltration, since past grading, filling, disturbance, and compaction can greatly alter original soil infiltration qualities. The greatest opportunity for infiltration retrofits exists in sensitive or impacted subwatersheds, where some of the original soil structure may still exist. By contrast, most soils in non-supporting subwatersheds are not likely to be suitable for infiltration. Some regions of the country still have excellent soils that allow for widespread implementation of infiltration retrofits (e.g., glacial tills, sand).

Pollutant Removal by Infiltration Retrofits

Infiltration retrofits utilize several pollutant removal mechanisms including filtering, soil adsorption and transfer to groundwater. Theoretically, nearly all the pollutants that enter an infiltration practice should be removed except for soluble pollutants that travel through groundwater and return downstream. It is important to note that infiltration retrofits **are not** intended to treat sites with high sediment or trash/debris loads, as they will cause the practice to clog and fail.

Very few infiltration practices have been monitored, so only limited pollutant removal

data has been published. Designers should therefore regard the infiltration pollutant removal rates shown in Table 1 as an initial estimate until more performance monitoring data becomes available.

Several site-specific and design factors can have a strong influence on infiltration pollutant removal rates (Table 2). As always, removal rates for individual retrofit projects should be adjusted to account for site-specific design factors that can enhance or diminish pollutant removal using the design point method. The most important design factor is the size of the individual retrofit in relation to the target WQv treatment. Pollutant removal rates diminish for under-sized infiltration retrofits; the recommended walkaway volume is about 50% of the target WQv.

Other Stormwater Benefits Provided by Infiltration

Infiltration retrofits are desirable because they confer other stormwater benefits:

Groundwater Recharge: Infiltration of stormwater runoff is the preferred means to provide groundwater recharge within a subwatershed. When designed properly, they can infiltrate the entire runoff reduction or WQv to keep stormwater runoff out of combined sewers.

Channel Protection: While infiltration practices are not specifically designed to store the channel protection volume, their ability to reduce runoff volumes should help protect downstream channels from erosion. If suitable soils are present across a subwatershed, infiltration may be an effective channel protection strategy.

Table 1: Range of Reported Removal Rates for Infiltration Practices			
Pollutant	Low End	Median	High End
Total Suspended Solids	60*	90*	95*
Total Phosphorus	50	65	95
Soluble Phosphorus	55	85	100
Total Nitrogen	0	40	65
Organic Carbon	80	90	95
Total Zinc	65	65	85
Total Copper	60	85	90
Bacteria	25	90	95
Hydrocarbons	85	90	95
Chloride	0	0	0
Trash/Debris	90*	95*	99*

* Adequate pretreatment must be provided to reduce sediment loads to infiltration practices or clogging and practice failure may result
 See Appendix D for data sources and assumptions used to derive these removal rates
 Low End and High End are the 25th and 75th quartiles

Table 2: Design Point Calculation to Estimate Pollutant Removal for Infiltration Retrofits		
Design Factors	X	Points
Exceeds target WQv by more than 50%		+ 3
Exceeds target WQv by more than 25%		+ 2
Tested infiltration rates between 1.0 and 4.0 in/hr		+ 2
At least two forms of pretreatment prior to infiltration		+ 2
CDA is nearly 100% impervious		+ 1
Off-line design w/ cleanout pipe		+ 1
Underdrain utilized		- 1
Filter fabric used on trench bottom		- 1
CDA more than 1.0 acre		- 1
Soil infiltration rates < 1.0 in/hr or > 4.0 in/hr		- 2
Pervious areas or construction clearing in CDA		- 2
Does not provide full WQv volume		- 3
NET DESIGN SCORE (max of 5 points)		

ST-7	Stormwater Treatment Options	
	SWALES	

Swales utilize the stormwater conveyance system to provide treatment in either storage or on-site retrofit applications. Swales have moderate pollutant removal capability, can reduce runoff volume and increase groundwater recharge. Swales are designed to treat the WQv within an open channel. The three design variants are the dry swale, wet swale, and grass channel.

Dry swales are a linear soil filter system that temporarily stores and then filters the desired WQv (Figure 1). Dry swales are similar to bioretention areas in that they rely on a fabricated soil bed on the bottom of the channel. Existing soils are replaced with a sand/soil mix that meets minimum permeability requirements. Dry swales provide a good environment for filtration, biological uptake, and microbial activity. Stormwater treated by the soil bed flows into an underdrain, which conveys treated runoff back to the conveyance system further downstream. The underdrain system is typically created by encasing a perforated pipe

within a gravel layer on the bottom of the swale.

Wet swales are linear wetland cells that intercept shallow groundwater to maintain a wetland plant community (Figure 2). Saturated soils support wetland vegetation, which provides an ideal environment for gravitational settling, biological uptake, and microbial activity.

Grass channels are open channels that provide limited water quality treatment using rate-based design criteria. Grass channels reduce flow velocities and increase filtration capacity. Grass channels generally cannot provide the same degree of pollutant removal as dry or wet swales.

All three swale designs provide significantly better water quality treatment than the conventional roadside ditch. Schematics of the dry and wet swale designs are illustrated in Figure 3.



Figure 1: Dry Swale



Figure 2: Wet Swale

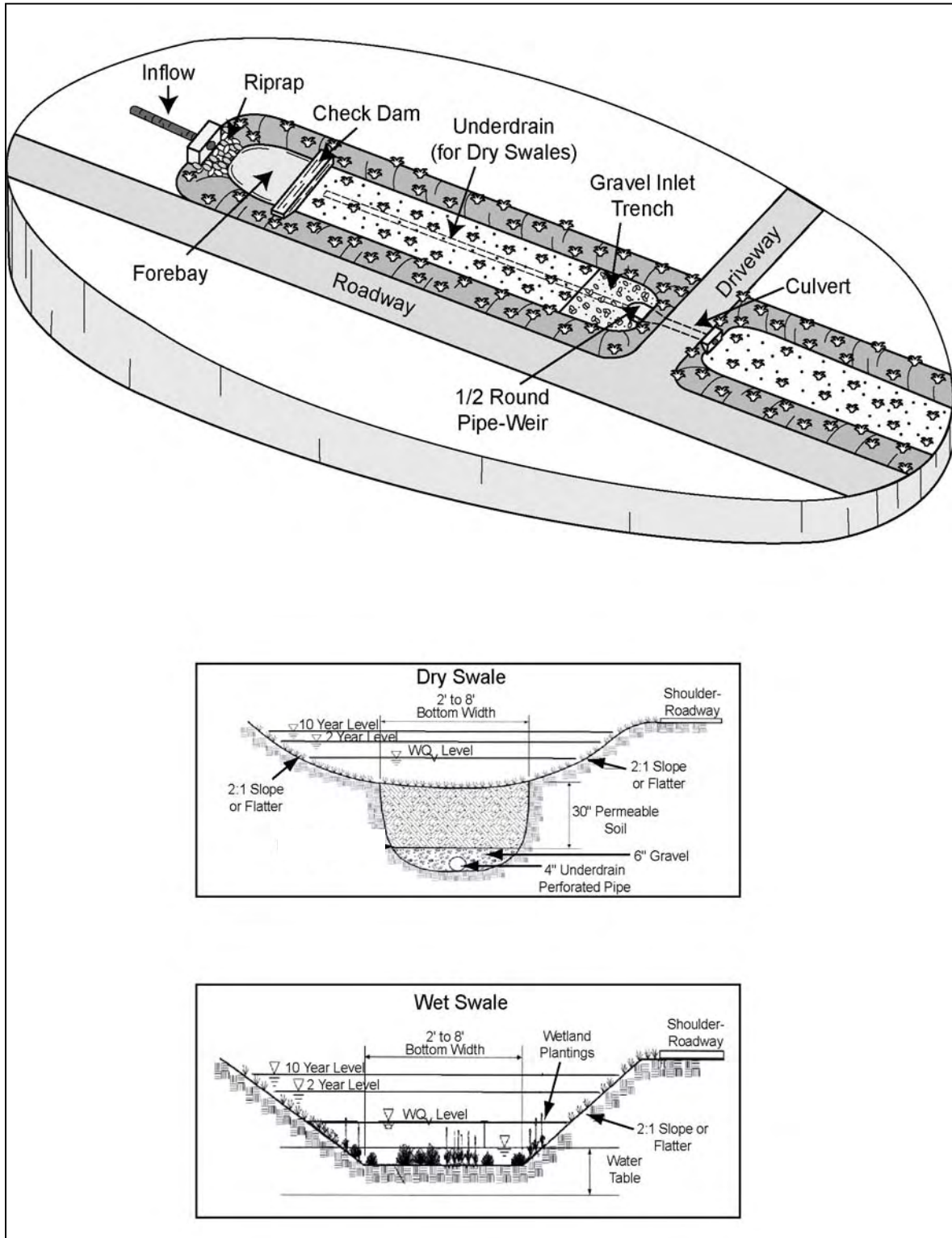

Figure 3: Schematic of a dry and wet swale

Typical Swale Retrofit Application

Most swale retrofits require that an existing open channel be widened, deepened, reduced in gradient, or some combination of all three. Swales are particularly well suited to treat runoff from low and medium density residential streets and small parking lots. Typical retrofit situations where swales can be applied include:

- **SR-4** Install dry swale or grass channel within existing conveyance system
- **OS-8** Install swales along margins of small parking lots
- **OS-9** Install swale retrofit along open section street or convert closed section street into dry swale
- **OS-11** Direct runoff to swale as means to disconnect a small impervious area

Estimating Pollutant Removal Capability of Swale Retrofits

The primary pollutant removal mechanisms operating in swales are settling, filtering

infiltration and plant uptake. The reported pollutant removal rates for swales are highly variable. Table 1 shows the range in removal rates for swales that have been specifically designed for stormwater treatment (e.g., dry swales, wet swales and biofilters). Please note that the median removal rates should be cut in half if the proposed retrofit is a grass channel.

Designers may find it difficult to define the expected removal rate for a swale retrofit. Many site conditions and design factors can enhance or diminish their pollutant removal rates (Table 2). A reasonable estimate for each individual swale retrofit can be developed using the design point method. A primary factor influencing swale removal rates is the proportion of the WQv that is actually infiltrated or stored within retrofit treatment cells. A second influential factor is how the retrofit is sized in relation to the target WQv-- the recommended walkaway volume is about 50% of the target WQv.

Table 1: Range of Reported Removal Rates for Swales

Pollutant	Low End	Median	High End
Total Suspended Solids	70	80	90
Total Phosphorus	-15	25	45
Soluble Phosphorus	-95	-40	25
Total Nitrogen	40	55	75
Organic Carbon	55	70	85
Total Zinc	60	70	80
Total Copper	45	65	80
Bacteria	-65	0	25
Hydrocarbons	70	80	90
Chloride	0	0	0
Trash/Debris	0	0	50

See Appendix D for data sources and assumptions used to derive these removal rates
Low End and High End are the 25th and 75th quartiles

Table 2: Design Point Calculation to Estimate Pollutant Removal for Swale Retrofits		
Design Factors	X	Points
Exceeds target WQv by more than 50%		+ 3
Dry or wet swale design		+ 2
Exceeds target WQv by more than 25%		+ 2
Longitudinal swale slope between 0.5 to 2.0%		+ 1
Velocity within swale < 1 fps during WQ storm		+ 1
Measured soil infiltration rates exceed 1.0 in/hr		+ 1
Multiple cells with pretreatment		+ 1
Off-line design w/ storm bypass		+ 1
Longitudinal swale slope < 0.5% or > 2%		- 1
Measured soil infiltration rates less than 1.0 in/hr		- 1
Swale sideslopes more than 5:1 h:v		- 1
Swale intersects groundwater (except wet swale)		- 1
No pretreatment to the swale or channel		- 1
Swales conveys stormflows up to 10 year storm		- 2
Does not provide full WQv volume		- 2
Grass channel		- 3
NET DESIGN SCORE (max of 5 points)		

Other Stormwater Benefits Provided by Swales

Swales retrofits can provide other stormwater benefits, including:

Groundwater Recharge: Swales can reduce runoff volumes by an average of 40% through infiltration on the swale bottom and across side-slopes, according to Strecker *et al.* (2004). Some research studies have reported as much as 80 to 90% runoff reduction for dry swales that are heavily landscaped with trees and shrubs to promote greater evapotranspiration (Horner *et al.*, 2003).

Channel Protection: While most swales are not designed to provide channel protection storage, the high degree of runoff reduction suggests that they have some potential to protect downstream channels from erosion. It may be possible to capture and detain the entire channel protection volume at small sites.

ST-8	Stormwater Treatment Options	
	Other Retrofit Treatment	

This stormwater treatment option includes a diverse group of on-site techniques that capture, store and partially treat rooftop runoff in residential areas and highly urban landscapes, including:

Residential Rooftops

- Rainbarrels
- Rain Gardens
- French Drains/Drywells

Non-Residential Settings

- Cisterns
- Green Rooftops
- Permeable Pavers
- Stormwater Planters

Each rooftop technique has a unique ability to reduce runoff, remove pollutants or recharge groundwater and differs greatly in its design, installation cost and maintenance needs. A full description of each treatment option is provided in the series of fact sheets provided in Appendix F.

Typical Retrofit Applications

Many of these practices are primarily used to treat runoff from individual rooftops (OS-10), but stormwater planters and permeable pavers can also be applied to retrofit small

parking lots (OS-8) and urban landscapes/hardscapes (OS-12).

Pollutant Removal Capability

These techniques can provide partial or full treatment of the target WQv, depending on site conditions. The pollutant removal rate for each technique varies greatly, so designers should consult the appropriate fact sheet in Appendix F to get an accurate estimate.

Benefits, Constraints, Concerns and Design, Construction and Maintenance Issues

Taken as a group, these stormwater treatment techniques are suitable for use in small, on-site retrofits and have few site constraints. Individually, each technique has numerous siting, design, and maintenance issues which are described in Appendix F.

Installation Costs for Other Stormwater Retrofits

The installation costs for this group of retrofits are compared in Table 1.

Table 1: Installation Costs for Other Stormwater Retrofits (per cubic foot treated)		
Retrofit Type	Median Cost	Cost Range
Residential Settings		
Rain Barrels	\$ 25.00	\$ 12.50 to \$ 40.00
Rain Gardens:		
Volunteer Installation	\$ 4.00	\$ 3.00 to \$ 5.00
Professional Installation	\$ 7.00	\$ 5.00 to \$ 10.00
Professional Landscaping	\$ 12.00	\$ 10.00 to \$ 15.00
French Drains/Drywells	\$ 12.00	\$ 10.50 to \$ 13.50
Non-Residential Settings		
Cisterns	\$ 15.00	\$ 6.00 to \$ 25.00
Intensive Green Rooftops	\$ 360.00	\$ 300.00 to \$ 420.00
Extensive Green Rooftops	\$ 225.00	\$ 144.00 to \$ 300.00
Permeable Pavers	\$ 120.00	\$ 96.00 to \$ 144.00
Stormwater Planters	\$ 27.00	\$ 18.00 to \$ 36.00
Rain Gardens	\$ 12.00	\$ 10.00 to \$ 15.00
<i>Note: See Appendix E for documentation and cost assumptions</i>		

Chapter 4: The Search For Storage - Finding Retrofit Opportunities at the Subwatershed Level

The search for storage requires considerable creativity by the retrofit team. The team should possess a practical understanding of hydrology, hydraulics, and stormwater engineering and a knack for sleuthing current infrastructure to envision possibilities for better stormwater treatment. This chapter presents the methods developed

by the Center to investigate retrofit potential at the subwatershed level. The basic eight step retrofit process is portrayed in Figure 4.1. This systematic approach is cost effective and can be used for both larger storage retrofits and smaller on-site retrofits. The purpose and tasks associated with each retrofit step are described in Table 4.1.

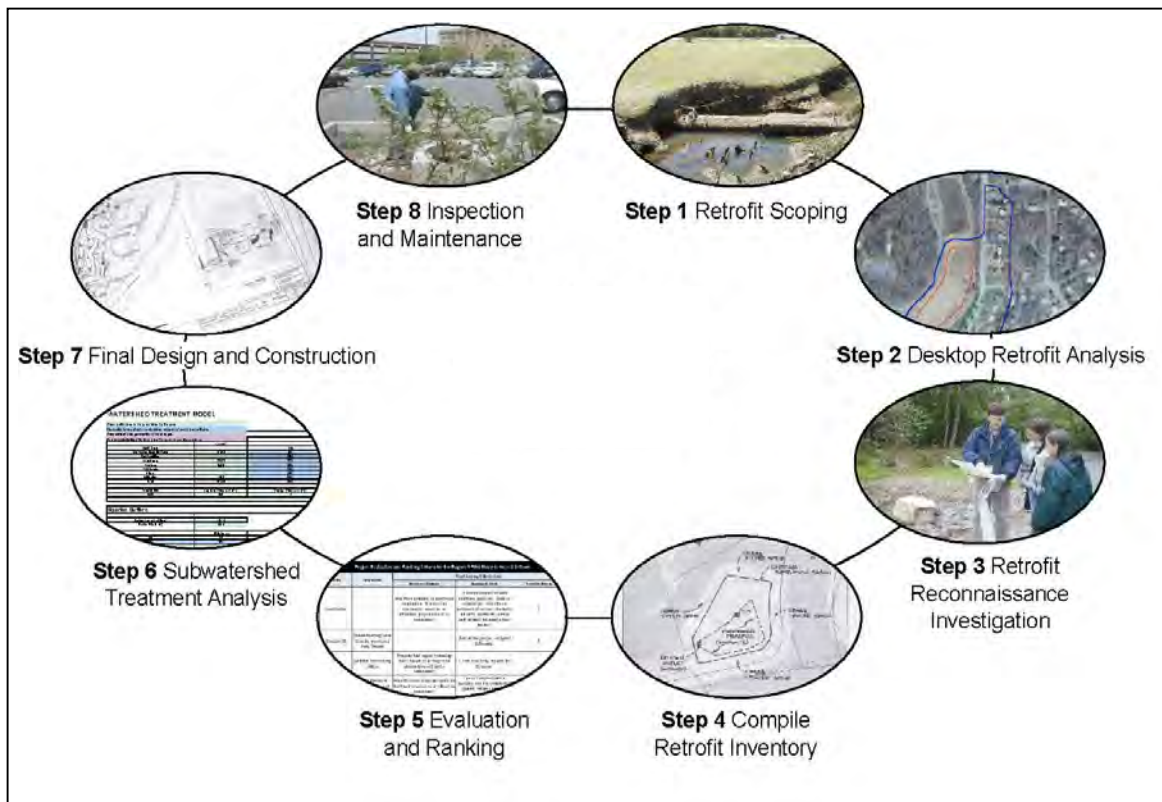

Figure 4.1: The eight steps of stormwater retrofitting

Table 4.1: Purpose of the Eight Steps in the Stormwater Retrofitting Process	
Step and Purpose	Key Tasks
<p>Step 1: Retrofit Scoping Refine the retrofit strategy to meet local restoration objectives</p>	<ul style="list-style-type: none"> • Screen for subwatershed retrofit potential • Review past, current and future stormwater • Define core retrofitting objectives • Translate into minimum performance criteria • Define preferred retrofit treatment options • Scope out retrofit effort needed
<p>Step 2: Desktop Retrofit Analysis Search for potential retrofit sites across the subwatershed</p>	<ul style="list-style-type: none"> • Secure GIS and other mapping • Conduct desktop search for retrofit sites • Prepare base maps for RRI
<p>Step 3 : Retrofit Reconnaissance Investigation Investigate feasibility of retrofit sites in the field</p>	<ul style="list-style-type: none"> • Advanced preparation • Evaluate individual sites during RRI • Finalize RRI sheets back in office
<p>Step 4: Compile Retrofit Inventory Develop initial concepts for best retrofit sites</p>	<ul style="list-style-type: none"> • Complete storage retrofit concept designs • Finalize on-site retrofit delivery methods • Assemble retrofit inventory
<p>Step 5: Retrofit Evaluation and Ranking Choose the most feasible and cost-effective sites</p>	<ul style="list-style-type: none"> • Neighborhood consultation • Develop retrofit screening criteria • Create retrofit project priority list
<p>Step 6: Subwatershed Treatment Analysis Determine if retrofits can achieve subwatershed restoration objective</p>	<ul style="list-style-type: none"> • Compute pollutant removal by storage retrofits • Compute pollutant removal by on-site retrofits • Compare against restoration objective
<p>Step 7: Final Design and Construction Assemble design package to lead to successful retrofit construction</p>	<ul style="list-style-type: none"> • Secure environmental permits • Obtain landowner approval and easements • Perform special engineering studies • Put together final design package • Contract and project management
<p>Step 8: Inspection, Maintenance & Evaluation Ensure retrofits are working properly and achieving subwatershed objectives</p>	<ul style="list-style-type: none"> • Construction inspection • Retrofit maintenance • Project tracking and monitoring

Step 1: Retrofit Scoping Process

Retrofitting should be fundamentally guided by the specific restoration goals chosen for the subwatershed, so the team should carefully scope out what they want to achieve at the outset. The retrofit scoping process involves six basic tasks:

Task 1. Screen for subwatershed retrofit potential (Optional)

Task 2. Review past, current and future stormwater management

Task 3. Define the core retrofitting objective

Task 4. Translate objectives into minimum retrofit treatment performance criteria

Task 5. Define the preferred methods of stormwater treatment

Task 6. Estimate retrofitting effort needed in the subwatershed

Task 1 Screen Subwatersheds for Retrofit Potential (Optional)

In some cases, the team needs to analyze a large group of subwatersheds to identify the ones with greatest retrofit potential. The team can perform a modified Comparative Subwatershed Analysis (CSA) to screen subwatershed retrofit potential across a larger watershed (see Manual 2). It is relatively easy to screen the most promising subwatersheds with stormwater retrofit potential from a desktop, assuming basic GIS layers are available. Once the

watershed has been subdivided into subwatersheds, retrofit screening metrics can be derived to discriminate among all of the subwatersheds. These simple metrics provide important clues about the comparative potential to find either storage or on-site retrofits within a subwatershed (Tables 4.2 and 4.3).

Each screening metric can be weighted and analyzed in a simple spreadsheet to determine the comparative retrofit potential of a group of subwatersheds. Both the screening factors selected and their relative weight will be unique for each watershed, and should be customized to reflect local retrofit objectives. Priority subwatersheds can then be selected based on their individual total scores.

Table 4.2: Subwatershed Metrics to Evaluate Storage Retrofit Potential

Screening Metric	What It Says About Retrofit Potential
Current Impervious Cover	Subwatersheds with moderate IC have greater retrofit potential since they offer a greater range of candidate sites and require less total stormwater storage to meet subwatershed objectives. (% of subwatershed)
Density of Stormwater Ponds	A high pond density indicates strong retrofit potential given the large number of possible sites to employ pond retrofits. (# of ponds per square mile)
Headwater Road Crossings	A high number of headwater road crossings increases potential for installing storage retrofits upstream of road crossings. (# of crossings per stream mile)
Available Area in Stream Corridor	Subwatersheds with more available open area in the stream corridor possess a greater number of potential sites for many types of storage retrofits, including new storage facilities split from outfalls. (acres per stream mile)
Density of Stormwater Outfalls	A high density of stormwater outfalls within a subwatershed indicates greater retrofit potential since every outfall represents a possible storage retrofit site, if flows can be split from the pipe to a down gradient treatment area. (number of mapped outfalls per stream mile)
Publicly Owned Land	Subwatersheds with a high percentage of publicly owned land have greater retrofit potential because publicly owned lands are the preferred location for storage retrofits. (% of subwatershed)
Subwatershed Stream Density	High stream density generally indicates greater retrofit potential since it suggests that more stream corridor is available to locate retrofit practices. (stream miles per square mile)
Large Area of Contiguous Impervious Cover	A high number of large parking lots or other contiguous impervious areas in a subwatershed present more opportunities for storage retrofits. (number of commercial parcels >5 acres per subwatershed)

Table 4.3: Subwatershed Metrics to Evaluate On-site Retrofit Potential	
Screening Metric	What It Says About Retrofit Potential
Average Age of Development	The age of development helps to determine the potential for on-site retrofits, since the nature of rooftop connections is associated with the building codes and practices of different eras. (decades)
Publicly Owned Land	Subwatersheds with a high percentage of publicly owned land have greater retrofit potential because publicly owned lands are the preferred location for on-site retrofits. (% of subwatershed)
Medium and Large Lot Residential Land	Subwatersheds with a high proportion of residential land have greater on-site retrofit potential, although this frequently needs to be confirmed by field assessments. (% of subwatershed)
Stormwater Hotspot Density	Subwatersheds with a greater hotspot density are expected to generate higher stormwater pollution loads, and may be targeted for on-site retrofits and pollution prevention practices. (no. of hotspots / square mile)
Industrial Land	Subwatersheds with a high % of industrial land have high on-site retrofit potential, since many industrial operations are already regulated and may need to install on-site retrofits to comply with stormwater permits. (% of subwatershed)
Presence of Combined Sewers	Subwatersheds that are served by combined sewers have greater on-site retrofit potential, since local utilities have a strong interest in reducing the runoff volumes delivered to the system that cause overflows. (presence or absence)
Subwatershed Redevelopment Potential	Subwatersheds undergoing redevelopment present great opportunities to cost effectively incorporate stormwater retrofits as a component of the overall site design and construction. (% of subwatershed)
Active Homeowner Association or Watershed Group	Subwatersheds with active groups have an existing network to promote on-site retrofit delivery.

Task 2 Review Past, Current and Future Stormwater Management

The team should understand past, current and future stormwater practices and design criteria within the community to identify retrofit possibilities. The following questions help the team find the best opportunities to treat runoff quality.

- What types of stormwater practices were installed in the subwatershed in the past? Can their performance or function be improved?
- Could ongoing flooding problems or drainage complaints be resolved through retrofitting?
- Are maintenance inspections performed on stormwater infrastructure in the subwatershed? If so, could the effectiveness of existing practices be upgraded through retrofits or maintenance repairs?
- What, if any, municipal stormwater permit requirements could support retrofitting?
- What is the future development potential within the subwatershed? Will future development projects be designed to more stringent stormwater management criteria?
- Are current stormwater sizing criteria and design standards for new development capable of meeting restoration or pollutant reduction goals?

- What are the prospects for achieving additional retrofit coverage through redevelopment and infill development?
- What opportunities exist to incorporate retrofits into future capital projects in the subwatershed?

The answers to these questions help the team understand how to deliver retrofit projects at the subwatershed level.

Task 3 Define Core Retrofitting Objectives for Subwatershed

The team should carefully define their core retrofitting objectives and designate a primary pollutant of concern. In some cases, the objective may have already been developed in the process of preparing a local subwatershed plan. If not, the team may want to:

- Analyze existing stormwater quality monitoring data to identify the pollutant(s) of concern.
- Consult with state water quality agencies to find out which pollutants are causing local water quality impairment.
- Review any pollutant load reduction goals contained in a Total Maximum

Daily Loads (TMDL) for the subwatershed, watershed or basin.

- Consult with aquatic ecologists to determine if fishery restoration is a realistic objective.
- Evaluate current and future Impervious Cover Model predictions to set achievable subwatershed restoration objectives, as subwatershed impervious cover can fundamentally constrain retrofitting objectives (Appendix A of Manual 1).
- Assess whether runoff reduction is needed to reduce combined sewer or sanitary sewer overflows. Determine whether retrofits are needed to complement planned stream restoration projects in the subwatershed.
- Review past stream assessments to evaluate stream habitat quality and the possible need for channel protection.

The outcome from this task may be a narrative or numeric description of the restoration objectives chosen for the subwatershed (Table 4.4). The team also designates a pollutant of concern and identifies the type of retrofit storage needed to meet the core subwatershed restoration objective (Table 4.5).

Subwatershed Objective	Action Required
Correct Past Mistakes	Address 50% of chronic drainage complaints
Reduce Flood Damage	Reduce incidence of events that inundate structures and roadways. Ensure "no damage" conditions for 50-year storm.
Trap Trash, Debris and Floatables	Capture 90% of trash and debris delivered to storm inlets
Create Wetland/Wildlife Habitat	Create or restore 100 acres of habitat in the subwatershed
Recharge Groundwater	Ensure 70% recharge rate for the first one inch of rainfall across the subwatershed
Reduce Bank Erosion	Reduce Q of channel-forming flow to acceptable shear stress levels
Support Downstream Repairs	Ensure that Q of channel-forming flow does not exceed stream repair design levels at build-out
Reduce Nutrient Loads	Reduce phosphorus load by 25% or to 0.30 pounds/acre/year across the subwatershed
Reduce Bacteria Loads	Reduce bacteria load to allocated levels for stormwater in TMDL
Reduce Metal/Toxin Loads	Provide treatment for 90% of confirmed hotspots

Retrofit Objective	Stormwater Treatment Model			
	Water Quality	Runoff Reduction	Channel Protection	Flood Control
Correct Past Mistakes	○	○	⊙	●
Reduce Flood Damage	○	○	○	●
Education/Demonstration	●	●	⊙	○
Trap Trash and Floatables	⊙	●	○	○
Reduce Flows to CSOs	⊙	●	○	○
Renovate Stream Corridor	●	○	⊙	X
Reduce Pollutant of Concern	●	X	●	X
Reduce Bank Erosion	○	⊙	●	○
Support Stream Restoration	●	⊙	●	X
Full Watershed Restoration	●	●	⊙	X
KEY ● Always ⊙ Usually ○ Sometimes X Never				

Retrofit Objective	Subwatershed Impervious Cover			
	10 to 25%	25 to 40%	41 to 60%	61 to 100%
Correct Past Mistakes	●	●	⊙	○
Reduce Flood Damage	●	●	⊙	○
Education/Demonstration	●	●	●	●
Trap Trash and Floatables	●	●	⊙	○
Reduce Flows to CSOs	●	●	⊙	⊙
Renovate Stream Corridor	●	●	⊙	○
Reduce Pollutant of Concern	●	●	●	⊙
Reduce Bank Erosion	●	⊙	○	×
Support Stream Restoration	●	⊙	○	×
Full Watershed Restoration	●	⊙	○	×

KEY
 ● Objective can normally be widely achieved across a subwatershed
 ⊙ Objective may be feasible, depending on individual reach characteristics
 ○ Objective can only be achieved in isolated reaches in the subwatershed
 × Objective is generally not achievable in the subwatershed

Task 4 Translate Objectives into Minimum Retrofit Treatment Performance Criteria

This task translates restoration objectives into performance criteria to guide future retrofitting efforts. Typically, this means defining a minimum level of treatment needed across a subwatershed to reduce the pollutant of concern to an acceptable level. This may be quantified either as a desired level of pollutant reduction (e.g., 25% total phosphorus reduction) or a target percentage of the subwatershed that will be treated by effective retrofits (e.g., 50% of subwatershed area). The maximum treatment area is often constrained by subwatershed impervious cover (Table 4.6). In most subwatersheds, it is hard to find enough feasible storage retrofits to treat more than 50% of subwatershed area. If the design team seeks a higher treatment percentage, they will need to consider on-site retrofits. The retrofit team may want to consult Table 4.7 to estimate the aggregate WQv storage needed in their subwatershed.

The retrofit team should also establish a minimum WQv storage needed for individual retrofit projects that achieve a minimum removal rate for the pollutant of concern. This is needed to eliminate retrofits that are so under-sized they cannot perform their primary pollutant removal function. The team would “walkaway” from a site when a retrofit falls below this volume or consider an alternative restoration practice. The walkaway volume for most stormwater treatment options ranges from 35 to 50% of the target WQv (see Chapter 3).

Task 5 Define the Preferred Methods of Retrofit Treatment

In this task, the team chooses the preferred stormwater treatment option(s) and retrofit locations for a subwatershed. This is also when the team decides whether to focus on storage retrofits, on-site retrofits, or both. Decisions on which stormwater treatment

Table 4.7: Steps to Determine The Retrofit Water Quality Volume

1. Define Area and Impervious Cover

The area and impervious cover for the retrofit site or the subwatershed as a whole can be directly measured. For operational purposes, impervious cover (I) is defined as any area of the site/subwatershed that is not covered by vegetation, and is expressed as a percentage.

2. Compute Subwatershed Runoff Coefficient

The volumetric runoff coefficient is defined based on the following equation:

$$R_v = 0.05 + 0.009 (I)$$

3. Choose Appropriate Water Quality Storm (S)

Choose the depth of rainfall associated with the 90% storm from the appropriate rainfall frequency spectrum.

The depth in inches can be converted into a unit area retrofit treatment scaling factor (X) by multiplying the depth (S) by 12, and then multiplying 43,560 square feet. The team may also want to define a smaller minimum walk-away volume for individual sites.

4. Compute Water Quality Volume (WQv)

The Water Quality Volume (WQv) expresses the acre feet of runoff that must be treated in an acceptable stormwater retrofit practice, and is computed as:

$$WQv = (R_v)(S)(A) (X)$$

Where = A = site or subwatershed area in acres

5. Compute Treatment Area Needed

Divide the WQv by an assumed depth of retrofit treatment to determine the estimated surface area (in acres) needed for retrofit treatment (usually ranges between 3 and 6 feet).

options to employ are usually based on their comparative ability to remove the pollutant of concern. For example, if the primary restoration objective is to reopen a public beach closed due to high fecal coliform levels, then the team would rely on stormwater practices with high and reliable bacteria removal rates. The team can analyze the more detailed pollutant removal tables provided in Chapter 3 to make an informed choice. Keep in mind that this task is only intended to justify using one treatment option over another when more than one could be used at the site.

Stormwater treatment options also differ in their ability to meet restoration objectives, such as channel protection or runoff reduction. Other key factors in choosing the

preferred stormwater treatment options are construction cost, hydrologic benefits and community acceptance. Chapter 3 and Appendix I provided comparative data on stormwater treatment options.

Next, the team must decide whether to search for storage retrofits or a combination of storage and on-site retrofits in the subwatershed. A storage retrofit approach is quicker, less expensive and usually more cost-effective, but may not achieve adequate treatment throughout the subwatershed or meet all restoration objectives. If the team elects to go with a storage retrofit approach, then they should decide which subwatershed locations are worth concentrating on during their field investigations (Chapter 2). If on-site retrofits are employed, the team will need to choose which general land uses

to target for widespread delivery (e.g., individual neighborhoods, municipal land, stormwater hotspots). Thousands of on-site retrofit opportunities are available in most subwatersheds, so the team needs to focus on areas with the greatest potential project delivery. Publicly owned lands such as municipal buildings, public works yards, schools and parks are often the first target for on-site retrofits, followed by privately owned stormwater hotspots, cooperating institutions or individual neighborhoods.

Task 6 Estimate Retrofitting Effort Needed in the Subwatershed

Once the team agrees on key retrofit scoping issues, it can estimate the staff effort needed to complete a retrofit investigation across the subwatershed. Generally, the effort needed to conduct the desktop analysis steps is driven by subwatershed size, whereas the field and design tasks are driven by the number of retrofit sites assessed. Table 4.8 presents guidance to estimate staff time to conduct various retrofit assessments for a 10-square mile subwatershed.

Step 2: Desktop Retrofit Analysis

In this step, the team searches for potential retrofit locations by completing three office tasks:

- Secure GIS layers and other mapping data
- Conduct a desktop search for retrofit sites
- Prepare the base field maps for the RRI

Task 1 Secure GIS Data and Other Mapping

A watershed-based Geographic Information System (GIS) can be employed in every step of the retrofitting process (Table 4.9). While a GIS is an ideal way to store, organize and evaluate retrofit data, aerial photos or existing paper maps can also be used. Table 4.10 outlines the essential and optional mapping layers needed to support the retrofit process and if they are needed in GIS format. Guidance on how to access individual data layers from federal and state sources can be found in Appendix A of Manual 2.

The most essential GIS layers for a desktop retrofit search are topography, hydrology, and aerial photos. Many of the data layers recommended in Table 4.10 can be derived from other GIS data, or may be available on paper maps.

Task	Unit	Staff Time
Retrofit Scoping *	Hrs / subwatershed	16
Secure GIS Mapping Layers *	Hrs / subwatershed	40
Retrofit CSA *	Hrs / subwatershed	40
Desktop Search for Retrofit Sites	Hrs / subwatershed	8
Prepare Base Maps for the RRI *	Hrs / subwatershed	24
Advance Field Preparation *	Hrs / subwatershed	8
Conducting the RRI	Hrs / site	2 (for storage retrofit) 1 (for on-site retrofit)
Project concept design	Hrs / site	8 (for storage retrofit) 2 (for on-site retrofit)
Assemble inventory	Hrs / site	2
Project ranking and evaluation	Hrs / subwatershed	40
Subwatershed treatment analysis	Hrs / subwatershed	60
* When conducting investigations across several subwatersheds within a watershed, cost savings may be realized for these tasks as some or all of the effort may be applicable to all subwatersheds.		

Step	Description	Purpose
1	Retrofit Scoping	Screen subwatersheds with best retrofit potential using comparative retrofit metrics.
2	Desktop Retrofit Analysis	Search for potential retrofit sites and prepare field maps for the Retrofit Reconnaissance Investigation.
3	Retrofit Reconnaissance Investigation	Confirm drainage and impervious area to sites in concept design and investigate retrofit feasibility factors.
4.	Retrofit Inventory	Store key data on concept designs for best retrofit sites.
5.	Retrofit Evaluation and Ranking	Develop project locator map and develop metrics for project ranking.
6.	Subwatershed Treatment Analysis	Develop input parameters for subwatershed treatment analysis modeling exercise.
7.	Final Design and Construction	Maintain and track retrofit project files with design computations, technical support, permit approvals, as-built plans and inspection records.
8.	Inspection, Maintenance and Evaluation	Track status of retrofit construction, inspection and maintenance in the subwatershed.

Table 4.10: Mapping Layers Recommended for Retrofitting		
Mapping Data	Data Status	Needed as GIS?
Hydrogeomorphic Features		
Topography 5-foot 2-foot 1-foot or finer	Essential Nice to have Nice to have	Essential Nice to have Nice to have
Hydrology	Essential	Essential
Wetlands	Essential	Recommended
100-year floodplain	Essential	Recommended
Soils	Essential	Recommended
Boundaries		
Watershed / subwatershed boundaries	Essential	Essential
Parcel boundaries	Essential	Recommended
Municipal boundaries	Recommended	Recommended
Land Use and Land Cover		
Aerial photos	Essential	Essential
Land use / land cover	Essential	Essential
Zoning	Nice to have	Nice to have
Roads	Recommended	Recommended
Buildings	Recommended	Recommended
Parking lots	Recommended	Recommended
Driveways	Recommended	Recommended
Sidewalks	Recommended	Recommended
Turf cover	Recommended	Recommended
Forest cover	Recommended	Recommended
Utilities		
Sanitary sewer lines	Essential	Nice to have
Storm drain network	Essential	Nice to have
Stormwater practices	Recommended	Nice to have
Stormwater outfalls	Recommended	Nice to have
Combined sewers	Recommended	Nice to have
Other utilities	Essential	Nice to have
Note: Other mapping layers might be needed in certain subwatersheds: conservation areas and easements; geology and karst areas; hazardous waste/materials sites; impaired stream segments; permitted NPDES dischargers; rare, threatened or endangered species; stream monitoring stations; underground storage tanks		

Task 2 Conduct a Desktop Search for Retrofit Sites

The team rapidly searches and screens potential retrofit sites in this task to save time in the field. In practice, as much as 3-10% of subwatershed area may be needed to install retrofit practices. Further, this land must be located in the right place and be controlled by the right landowners. These land requirements

would seem to be unattainable in most subwatersheds. In reality, many excellent retrofit opportunities can be discovered through detailed map work, given a practiced eye and some imagination. The simple desktop search relies on a visual inspection of recent aerial photography.

A more systematic search for storage retrofit sites is always recommended when

subwatershed GIS data are available. The search criteria outlined in Table 4.11 can be used to screen down to a manageable list of potential sites. While GIS is seldom used to search for individual on-site retrofits, it can help identify general subwatershed locations

where they are most feasible. Potential on-site retrofit sites can be found by analyzing prior USSR surveys conducted for the subwatershed. Table 4.12 describes the useful on-site retrofit information that can be gleaned from USSR data.

Table 4.11: Desktop Search Criteria for Different Retrofits	
Retrofit Location	What to Look For
SR-1: Existing Pond	Evaluate stormwater layer to find existing stormwater ponds with a contributing drainage area greater than 5 acres <i>or</i> Superimpose topography, drainage layers and aerial photos to identify low points in the drainage network where dry ponds may exist.
SR-2: Roadway Culvert	Superimpose topography and headwater stream layers (zero, first and second order) over the local and state road network to identify road crossings.
SR-3: Below Outfall	Superimpose publicly-owned stream corridor land parcels at least two acres in area with storm drain outfalls with a diameter greater than 12 inches and less than 60 inches.
SR-4: Conveyance System	Superimpose ditch lines, zero-order streams, conveyance easements or open channels with open land adjacent to the drainage network
SR-5: Transport Right-of-Way	Compare local, state or federal highway right-of-way layers against the stream or drainage network to identify open spaces one acre or greater <i>or</i> review highway agency GIS for existing stormwater infrastructure or treatment practices suitable for retrofitting.
SR-6: Large Parking Lot	Match large contiguous parking areas/rooftops greater than 5 acres in size with adjacent open land in public or institutional ownership, or owned by the same landowner.
OS-7: Hotspot Operation	Review land use maps to identify commercial, industrial, or municipal land uses <i>or</i> search permit databases to identify industrial operations that hold stormwater permits.
OS-8: Small Parking Lot	Search for parking lots less than five acres in size that are municipally or institutionally owned.
OS-9: Individual Street	Screen for streets that meet street retrofit feasibility criteria, such as slope, right-of-way width, open section drainage, presence/absence of sidewalks and parking lanes.
OS-10: Individual Rooftop	Superimpose property ownership layers with aerial photos or planimetric data to locate large municipal, institutional, commercial or industrial buildings that may be assessed for demonstration rooftop retrofits <i>or</i> look for clusters of building permit data that indicates areas experiencing active redevelopment
OS-11: Little Retrofit	A desktop search is not helpful in finding specific locations for little retrofits, although a GIS can help find tax reverted vacant lots and publicly owned parcels, such as parks, schools, recreation centers to investigate in the field.
OS-12: Landscape/Hardscapes	A desktop search is not helpful in finding specific locations for landscaping and hardscaping retrofits although it can find the general public spaces with high exposure and outdoor amenities, such as parks, schools, central business districts, spaces etc.
OS-13: Underground	A desktop search is not helpful in finding specific locations for underground retrofits, although storm sewer and utility maps are essential for field investigations.

Table 4.12: How the USSR Helps Find On-site Retrofits

Neighborhood Source Assessment

- Examines the percentage of homes with connected rooftops, and other feasibility factors relating to on-site stormwater retrofits
- Evaluates potential storage retrofits of existing stormwater ponds in common areas

Hotspot Site Investigation

- Rates the severity of each hotspot with regard to its potential to generate stormwater runoff or illicit discharges
- Examines the feasibility of on-site storm water retrofits

Pervious Area Assessment

- Evaluates retrofit potential within large parcels of open land (2 acres or greater)

Streets and Storm Drain Analysis

- Ranks the severity of pollutant accumulation on roads and within storm drain systems, and the potential for street sweeping and storm drain cleanouts
- Assesses parking areas for on-site retrofit potential

Task 3 Prepare the Base Field Maps for the RRI

Field maps are needed to conduct the Retrofit Reconnaissance Investigation (RRI). The level of mapping detail is largely determined by available data and preferences of the field crew. The basic purpose of a field map is to orient field crews about where they are in a subwatershed, help them accurately record findings, and record basic topographic and site data.

The base field map should include aerial photography, topography (minimum of 5-foot contours) and hydrology. The map should also show candidate storage retrofit sites and their corresponding drainage areas. Some teams may also add the existing storm drain network and stormwater practices to the base map to make field investigations easier.

A maximum map scale of 1:2,400 is generally recommended for the base map (1" = 200'). Map scales greater than 1:6,000 (1" = 500') make it hard to find smaller retrofits, key ditch lines and first order

streams. Base maps should contain a standard map scale with scaleable intervals (e.g., 25 feet, 50 feet, 100 feet) so distances and areas can be easily determined in the field (Figure 4.2).

It may be worth taking other maps into the field for reference purposes; in particular, land use, wetland, property ownership or utility maps can reveal possible site constraints. While these layers could be added to the base map, they tend to clutter it and make it hard to read. The crew can



Figure 4.2: This sample base map includes aerial photography, 5-foot contours, hydrology, and locations of sites to be assessed.

always analyze these maps after the RRI is done to assess individual retrofit feasibility.

Step 3: The Retrofit Reconnaissance Investigation

The RRI is a rapid field assessment of potential storage and on-site retrofit sites conducted across a subwatershed. The purpose of the RRI is to verify the feasibility of candidate sites and to produce information to support initial concept designs. The RRI involves a careful assessment of site-specific information to determine if a retrofit will actually work at a specific site. Three tasks are needed to complete an RRI:

1. Advance preparation in the office
2. Evaluate individual retrofit sites using RRI form
3. Finalize RRI forms back in the office

Task 1 Advanced Preparation

The retrofit team leader is responsible for gathering the equipment and materials needed for field work, as outlined in Table 4.13. The equipment is used to either

document a retrofit site (e.g., GPS unit and digital camera) or assess basic site constraints (e.g., measuring tape, pocket rod, soil auger, and manhole puller). Several dozen blank copies of the RRI field form should be copied on three-hole paper and organized into a three-ring binder (see Appendix A for a blank RRI form). The RRI form can also be entered into a hand-held data storage device.

A retrofit field guide summarizes subwatershed retrofit objectives, sizing rules, standard setbacks, wetland indicators and other information to assist the crew. The level of detail provided in the field guide is calibrated to the retrofit experience of the field crews. Experienced crews generally need little guidance, whereas less experienced crews may need more consistent information on retrofit options. The guide ensures that all crews take a similar retrofitting approach – looking for specific types of retrofits per the subwatershed objectives, following the same sizing rules, etc. A template for customizing a retrofit field guide for an individual watershed can be found in Appendix A

Table 4.13: Getting Ready for the RRI

Equipment	Base Map
<ul style="list-style-type: none"> • Clipboards and pencils • GPS unit • Digital camera • Scale and pocket calculator • 100-foot measuring tape • Pocket rod or local level • Soil auger • Manhole puller, tennis ball • Safety gear (cell phone, first aid kit, etc.) 	<ul style="list-style-type: none"> • Aerial photos • Topography (5-foot contours) • Hydrology • Storm drain network • Existing stormwater practices • Street names • Sites to be assessed and contributing drainage areas
Materials	Supplementary Maps (If Available)
<ul style="list-style-type: none"> • Field forms • Retrofit field guide • Authorization letters • Contact numbers for emergency assistance • Photo IDs and business cards 	<ul style="list-style-type: none"> • Road map • Land use • Wetlands • Property ownership • Utility maps (if not available as GIS)

Authorization letters are recommended if crews are assessing sites in or near private property (Figure 4.3). The letters should be printed on local government letterhead and include the following information:

- Name and contact information of someone who can be contacted to answer questions about the project
- Purpose of the inventory and explanation of what the field crew is doing
- Dates and times that the field work will be conducted
- Company and names of staff conducting the field work

It is a good idea to mail copies of the authorization letter to property owners in advance of the field work. Field crews should carry several copies of the letter to give to suspicious residents, and remember to leave a copy on the windshield of field cars. The crew should be supplied with a list of emergency contact numbers to report any leaks, spills, or other water quality problems they encounter to the appropriate local authorities (Figure 4.3).

A retrofit inventory crew normally consists of two people who can visit from 10 to 15 sites each day. Typically, one member of the field team is responsible for completing the RRI form, while the other takes digital photographs and generates GPS points. Both crew members should work together to investigate the site and to brainstorm potential retrofit concepts. Ideally, at least one crew member should have prior retrofitting experience or be well versed in stormwater engineering. The second crew member should have a basic understanding of hydrology, subwatershed retrofit objectives, and the types of plumbing

indicators to look for at a site. Since retrofitting requires creativity, consider mixing field crews. For example, pairing an engineer with a biologist or a landscape architect may result in a retrofit that achieves stormwater treatment goals, but is also more sensitive to biological impacts and native vegetation. The crew leader should arrange for an orientation before going out in the field to ensure crews:

- Understand overall retrofit objectives and the preferred methods of stormwater treatment
- Agree on how to complete the RRI form and properly assign site IDs
- Understand the symbols used on the base maps
- Know who to call in case of emergencies.

Preliminary routes can be planned for the subwatershed to visit the candidate retrofit sites. Well-planned routes will help maximize efforts, but flexibility is also important. Field conditions are often different than expected and new retrofit opportunities may be discovered in the field that were not identified in the office.

Task 2 Evaluate Individual Retrofit Sites Using RRI Form

The crew completes the seven parts of the RRI form at each individual retrofit site:

1. Header Information
2. Site Description
3. Drainage Area to Proposed Retrofit
4. Existing Stormwater Management
5. Proposed Retrofit
6. Site Constraints
7. Sketch and Notes

240-777-Dump

WATER POLLUTION PHONE NUMBERS TO CALL WHEN A WATER QUALITY PROBLEM IS OBSERVED OR TO OBTAIN FURTHER INFORMATION ABOUT WATER QUALITY ISSUES
Spring 2001

COUNTY AGENCIES	INTER-COUNTY AGENCIES
DEP: Department of Environmental Protection DEPC: Division of Environmental Policy & Compliance WMD: Watershed Management Division	MNCPCC: Maryland/National Capital Park & Planning Commission WSSC: Washington Suburban Sanitary Commission
DPS: Department of Permitting Services LDS: Land Development Services SWM: Stormwater Management WS: Wells & Septic	DHCD: Department of Housing & Community Development DPWT: Department of Public Works & Transportation

PROBLEM/QUESTION	AGENCY & TELEPHONE NUMBER
ILLEGAL DUMPING HOTLINE	DEPC: 240-777-7700 Daytime hours → Nighttime hours 240-777-DUMP (3887) or 240-777-7788
Blocked storm drain, inlet or pipe or erosion from public storm drain	DPWT: 240-777-ROAD (7823) Highway Maintenance
Discolored public drinking water, odor to drinking water	301206-4002
Erosion, flooding, drainage problems between private properties	DHCD: 240-777-3600 (Code Enforcement)
Erosion - stream banks on park land	MNCPCC: 301485-2535
Fire & Rescue Services (emergencies: 911)	(Non-Emergencies): 240-777-0744
Recycling Programs/Special pick up services	DPWT: 240-777-6400 or 6466
Sanitary sewer problems	WSSC: 301206-4002
Sediment (mud) from construction site entering streams	LDS: 240-777-6366
Septic Leaks/ Septic Tanks	WS: 240-777-6300
Stormwater Management, pond safety and maintenance	DEPC: 240-777-7114
Stormwater Management and Sediment Control Plan Review issues	SWM: 240-777-6320
Stream Clean-ups	WMD: 240-777-7112
Swimming Pool Discharges	DEPC: 240-777-7770
Trash and debris in parks and streams	MNCPCC: 301485-2535
Water main break	WSSC: 301206-4002
Water pollution (discharging, dumping, chemical spills into streams or storm drains)	DEPC: 240-777-7770
Water quality monitoring programs for schools (Stream Teams)	LDS: 240-777-6260
Wells and Well Inspections	WMD: 240-777-7114 WS: 240-777-6300

askDEP.com

Westchester
gov.com

Andrew J. Spiano
County Executive

Soil and Water
Conservation District
Stephen Coleman
Chair

June 13, 2006

To Bronx River Watershed Landowners and Others:

The Bronx River Watershed Coalition, comprised of representatives of municipalities, state agencies and not-for-profit organizations and administered by the Westchester County Department of Planning and Soil and Water Conservation District, has partnered with the Center for Watershed Protection to conduct upland assessments and other fieldwork in the Bronx River watershed. The goal of these assessments is to identify priority restoration projects in the watershed. Once projects are identified, we will work cooperatively and assist landowners and any other appropriate entities to improve water quality and fish and wildlife habitats in the watershed.

This letter is to notify you that fieldwork for this endeavor will be conducted between 8:00 a.m. and 6:00 p.m. from June 13, 2006 through June 14, 2006. Field crews will conduct as much of the assessments as possible from their cars and will make every effort to avoid private property.

If you have any questions, please contact John Smith with the Westchester County Department of Planning/Soil and Water Conservation District at (123) 456-789 or john.smith@localgov.com

Thank you for your assistance.

Sincerely,

Bronx River Watershed Coalition and Center for Watershed Protection

Westchester County Soil & Water Conservation District • Westchester County Department of Planning
612 Middleham Office Building • 148 Main Street • White Plains, NY 10603 • (914) 997-4422 • (914) 997-3766 fax
Website: www.westchestergov.com

Figure 4.3: List of Emergency Contact Numbers (left) and Sample Authorization Letter (right)

An RRI form should be filled out for every candidate retrofit site visited, even if it appears infeasible. The next section provides guidance on how to complete each part of the RRI form.

Task 2a: Complete Header Information

Upon arrival at a candidate site, the retrofit crew documents some basic background information, such as:

- The name of the watershed, subwatershed, and the unique site ID number
- Date the site was visited and names of crew conducting the investigation
- Photographs taken at the site, including the specific camera used and the numbers of photographs taken

- Site coordinates, the specific GPS unit used to take them, and landmarks (LMK).

As a general convention, the unique site ID should reflect the subwatershed in which the retrofit is located, and indicate the retrofit location type (e.g., SR-3). An example of unique site ID nomenclature guidance is provided in Figure 4.4. Some crew leaders like to assign a unique site ID number prior to going into the field. If ID numbers are pre-assigned, the crew should be given a range of unassigned numbers to record any unexpected retrofit opportunities encountered in the field. If a GPS unit is unavailable, the site location should be estimated and marked on the base map.

Subwatershed Name		Subwatershed Acronym	
White Plains Reservoirs		WPR	
Kensico Reservoir		KR	
Manhattan Park Brook		MP	
Davis Brook		DB	
Clove Brook		CB	
Bronx River Middle Direct Drainage		BRM	
Bronx River Lower Direct Drainage		BRL	
Bronx River Upper Direct Drainage		BRU	
Sprain Brook		SB	
Grassy Sprain Brook		GSB	
Grassy Sprain Brook Direct Drainage		GSD	
Hartsdale Brook		HB	
Fox Meadow Brook		FMB	
Fulton Brook		FB	
Troublesome Brook		TB	

Investigation Type	Acronym
Hotspot Site Investigation	H
Neighborhood Source Assessment	N
Pervious Area Assessment	P
Retrofit Reconnaissance Investigation	R

Sequential Numbering begins at "1" for each subwatershed

Examples:
MPB-R1; MPB-R2; MPB-R3; MPB-R4...
HB-R1; HB-R2; HB-R3; HB-R4...

Figure 4.4: An example of unique site ID nomenclature guidance provided to retrofit teams in advance of field work.

Task 2b: Describe the Site

The retrofit crew then takes a few moments to generally describe the proposed retrofit site, including:

- The street address or name of the adjacent business or property owner.
- Whether the property is publicly or privately owned.
- The approximate location of the proposed storage or on-site retrofit

The crew then estimates the available treatment area for the footprint of the retrofit as defined by the largest contiguous unutilized area that has:

- No surface indicators of underground utilities
- No mature forests or wetlands
- Standard setback distances to structures, roads or shorelines

The crew estimates the area in acres (or square feet) either by pacing or drawing a rough footprint on the base map and scaling

approximate dimensions, using common area formulas for rectangles, triangles, or circles. More accurate estimates can be generated using a planimeter back in the office.

Task 2c: Evaluate Drainage Area and Plumbing to Proposed Retrofit

The crew then delineates the drainage area to the proposed retrofit site and estimates its total area and impervious cover. Although boundaries can be hard to define, crews need to confirm the drainage area to estimate the target storage volume to size the retrofit. If possible, the crew can delineate the drainage area for larger storage retrofits before going out into the field.

In some cases, maps are not adequate to delineate drainage boundaries, so the crew will need to investigate the drainage area in the field. This entails walking or driving around the site and observing drainage features that define its boundaries. The crew should begin at the proposed retrofit site and move upstream following common

indicators of stormwater plumbing such as open channels, curbs and gutters, storm drain inlets, manholes, outfalls, evidence of overland flow, and surface topography (Figure 4.5). The crew then marks the projected drainage boundaries on the field map using topography as a guide. Once the boundaries are established, drainage area may be roughly estimated using a scale. Next, the crew estimates the impervious cover for the retrofit drainage area. This can be done in the office using planimetric GIS data, aerial photography, or average land use/impervious cover relationship (provided in the field guide in Appendix A).

The drainage area investigation for on-site retrofits must be completed in the field and is basically a micro version of the process done for storage retrofits (Figure 4.6). The crew walks the site in an up-gradient direction to look for rooftop drainage,

downspouts, curb cuts, and drainage divides. Subtle grades can be deceiving, so the crew may want to roll a tennis ball to determine probable flow paths. The estimated drainage boundaries to the proposed on-site retrofit can be marked on the RRI field form. The area can be estimated by pacing or a tape measure. In addition, the crew should make a visual estimate of impervious cover for the contributing drainage area.

The crew then investigates existing plumbing at the site to look for retrofit opportunities. Crews should look for key stormwater infrastructure indicators to sketch out the existing drainage patterns at the site. The job is much easier if as-built plans are available for the site (Figure 4.7). Each storage and on-site retrofit location has different plumbing. Tables 4.14 and 4.15 provide some tips on what to look for in the field at each retrofit location.

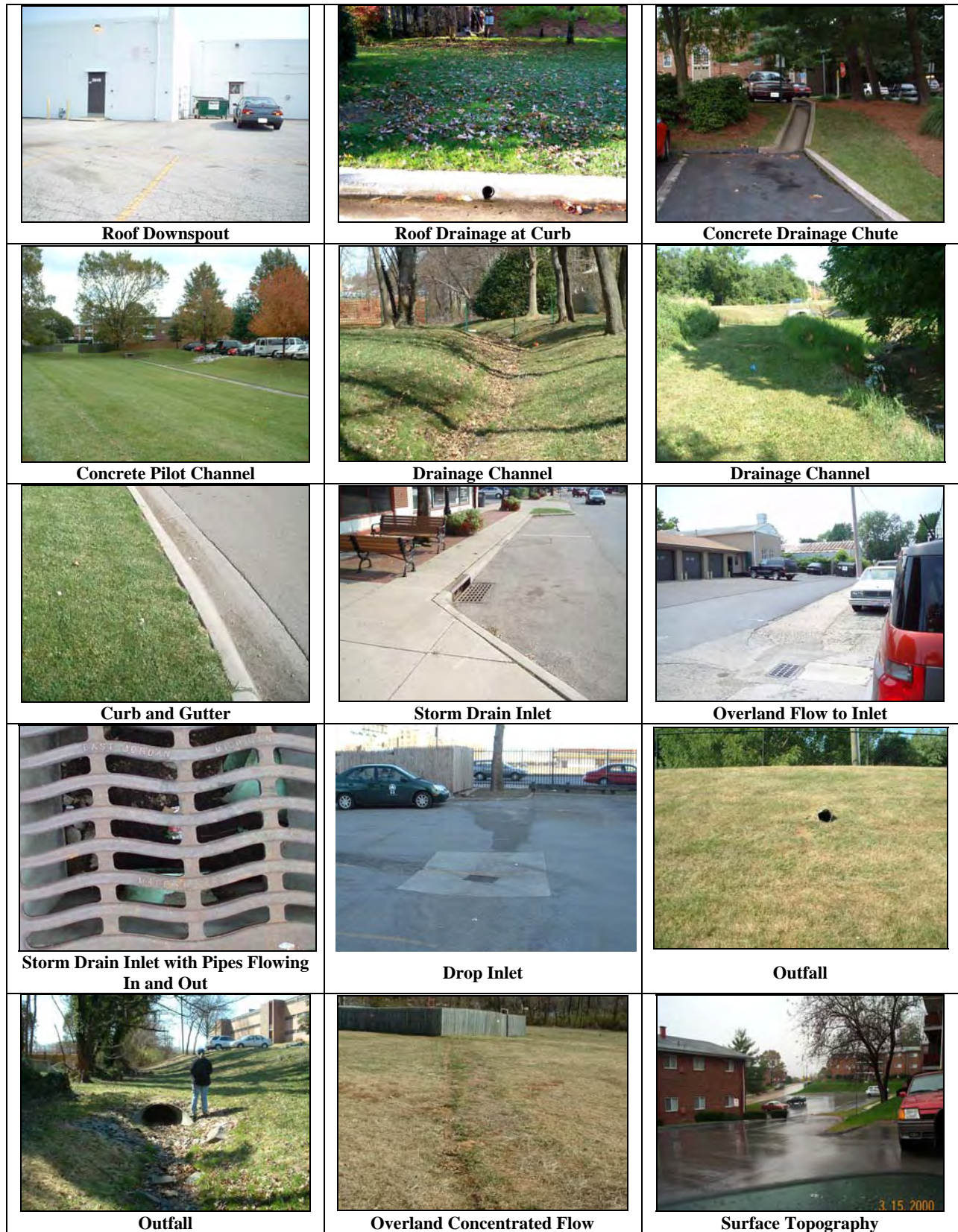

Figure 4.5: Examples of Stormwater Infrastructure Indicators

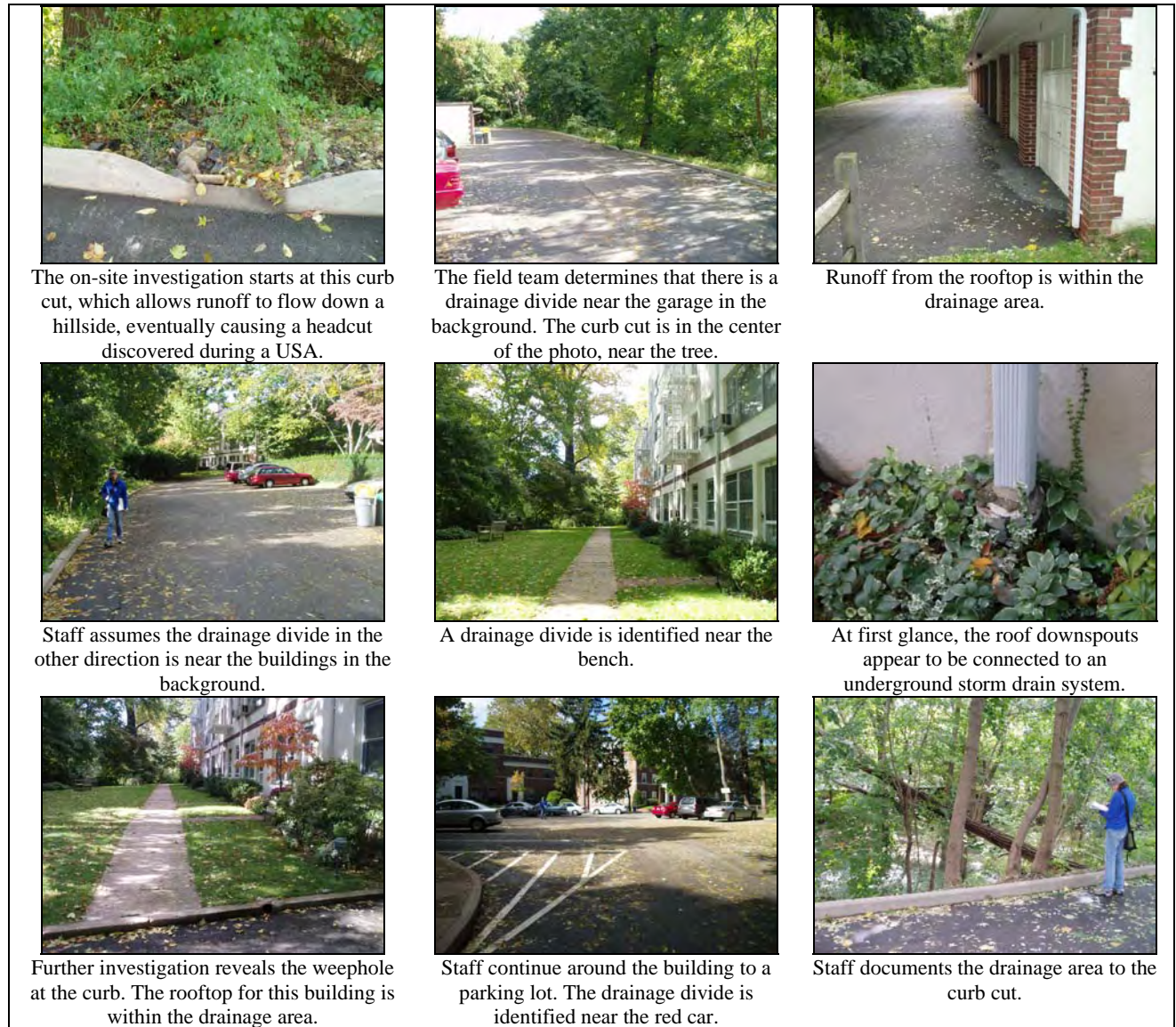

Figure 4.6: Investigating the drainage area at an apartment complex



Figure 4.7: While comparing an existing stormwater treatment practice to the original plans, the retrofit team realizes that the trash rack was never installed.

Table 4.14: What to Look for When Investigating Storage Retrofit Locations	
SR-1: Existing Pond	
<ul style="list-style-type: none"> • Check the condition and elevation of pond inlet(s), internal flow path, outlet, riser and emergency spillway. Check the condition of pond outlet to determine if it is damaged or prone to clogging. Look for excessive sediment deposition, chronic maintenance problems, and woody growth. • Walk above and below the pond to look for possible headwater effects and scour problems to correct, and verify the drainage area. • Decide which retrofit strategy to use: excavate pond bottom, raise embankment, steal flood control storage, modify the riser, improve internal design geometry or add forebay. 	
SR-2: Above Roadway Culvert	
<ul style="list-style-type: none"> • Evaluate the culverts alignment and invert elevation in relation to the stream, its diameter, material and condition, and potential to create a hydraulic jump. Note any sediment deposition. • Estimate the potential storage volume available upstream using prism method. Get a quick sense of whether the floodplain soils are suitable for excavation to get additional storage, Record the presence of any upstream wetlands, mature forest cover or underground utilities. • Evaluate downstream conditions – Measure the vertical distance from the culvert invert to the stream bed, estimate the rate of flow over the culvert lip, look for scour holes, and look for any flood prone structures in the floodplain. 	
SR-3: Below Outfall	
<ul style="list-style-type: none"> • Determine whether or not a flow splitter is needed to direct runoff for treatment. • Record the size, diameter, material and condition of both the storm drain pipe and outfall. • Measure the vertical distance between the elevation of the outfall invert, the stream bottom and the top of bank. • Define available treatment area below either side of the proposed split and then establish the point where split flows will enter proposed treatment area. Get a sense of soil conditions and depth to water table. • Look for the best place to bring treated flows back into the stream. 	
SR-4: In the Conveyance System	
<ul style="list-style-type: none"> • Evaluate channel conditions, including slope, depth, cross-section, soil conditions, vegetative cover, roughness, and signs that it is over-capacity. • Evaluate adjacent treatment potential to the right or left of the channel, including available width, indicators of utilities, potential access points, turf areas in depressions, and adjacent land uses. • Walk several hundred feet in a downstream direction to get a sense of where the channel transforms into a perennial stream, looking for signs of perennial flow, wetlands, and advancing knickpoints. 	
SR-5: In Transport Right-of-Way	
<ul style="list-style-type: none"> • Check to see whether the highway has open or closed drainage and try to delineate the upstream drainage divide (generally smaller ditches and smaller diameter pipes are preferred). • Sketch out the contributing drainage area and flow path and compare against highway design drawings. • Look for obvious depressions in a down gradient direction that can provide treatment without major excavation. • Ensure that space is available to account for standard highway safety setbacks. • Measure the hydraulic head available for stormwater treatment. 	
SR-6: Large Parking Lot	
<ul style="list-style-type: none"> • Confirm the size and use of the parking lot. • Assess parking lot grade and sketch the existing plumbing. • Estimate the boundaries of the treatment area. • Evaluate head and conduct a cursory inspection of soil conditions. • Determine if a flow splitter is needed to direct stormwater into the proposed treatment area. 	

Table 4.15: What to Look for When Investigating On-Site Retrofit Locations	
OS-7: Hotspot Operation	
<ul style="list-style-type: none"> • Define the hotspot generating area (HGA) • Evaluate pollution prevention practices • Evaluate hotspot connection to public storm drain system • Define the contributing drainage area to the hotspot generating area 	
OS-8: Small Parking Lot	
<ul style="list-style-type: none"> • Confirm the size and use of the parking lot • Eyeball parking lot grade and subdivide into smaller drainage units • Evaluate each on-site treatment area for available space • Determine how the treatment area can be reconnected to the existing storm drain system 	
OS-9: Individual Street	
<ul style="list-style-type: none"> • Investigate existing street conditions, current uses of the right-of-way/front yards, and the location and elevation of the downstream discharge point of entry into storm drain system • If open section drainage, note channel characteristics, utility conflicts, and distance between driveway culverts • If closed section drainage, note locations and characteristics of all storm drain inlets and catch basins 	
OS-10: Individual Rooftop	
<ul style="list-style-type: none"> • Talk to homeowners to gauge their willingness, retrofit preferences and past home drainage issues • Evaluate general rooftop conditions in the neighborhood and estimate the contributing roof area to a typical roof leader • Measure the length of the flow path from the roof across pervious areas • Use screwdriver or soil auger to get a sense of lawn compaction and soil quality 	
OS-11: Little Retrofits	
<ul style="list-style-type: none"> • Check to see if the impervious area is really needed • Walk in a down-gradient direction and follow the flow path from the impervious area to the storm drain or channel system • Find a place where sheetflow can be split or otherwise diverted into a pervious area for treatment • Check to see if there is runoff to adjacent impervious area (look for evidence of erosion) 	
OS-12: Landscape – Hardscape	
<ul style="list-style-type: none"> • Look for opportunities to eliminate impervious areas, to treat rooftop runoff and to expand existing tree pits • Ensure sidewalks and plaza areas are sloped towards treatment areas • Compare the surface area delivering runoff to the surface area of the planting area • Determine where treatment areas will overflow • Note potential conflicts with pedestrian traffic and access 	
OS-13: Underground	
<ul style="list-style-type: none"> • Look for indicators of underground utilities • Pop any manholes or grates to determine the invert elevation and diameter of the storm drain pipe that will accept runoff from the underground treatment area 	

Task 3: Size the Proposed Retrofit

At this point, the crew considers how to translate subwatershed objectives into a retrofit design for the site and collect information needed for retrofit ranking later on. This involves computing the target and actual storage volumes at the proposed retrofit site and choosing the best stormwater option.

Task 3a. Compute the Retrofit Storage Volume

The crew estimates the target storage volume needed for the retrofit site established earlier during retrofit scoping – water quality, runoff reduction, or channel protection. The normal target for water quality is to capture and treat the 90% storm, as defined by the local rainfall frequency

spectrum (see Chapter 1). The target storage volume is computed as a standard rainfall depth across the drainage area, using the following simple equation:

$$V_t = P/12 * R_v * DA$$

Where:

V_t = Target storage volume (acre feet)

P = Target rainfall depth (in inches for the 90% storm)

R_v = Runoff Coefficient = $0.05 + 0.009(IC)$

DA = Drainage Area (acres)

12 = Conversion factor (inches to feet)

If channel protection is a main concern, the basic goal will be to provide 24 hours of extended detention for the runoff generated from the 1-year 24-hour design storm. As a rule of thumb, the target storage capacity for channel protection is about 60% of the one-year storm runoff volume. The following equation can be used to estimate target storage for channel protection:

$$V_t = P/12 * IC/100 * DA * 0.6$$

Where:

V_t = Target storage volume (acre feet)

P = One-year 24-hour storm depth (inches)

IC = Impervious Cover (%)

DA = Drainage Area (acres)

12 = Conversion factor (inches to feet)

0.6 = Pond routing factor

Task 3b. Compute Available Retrofit Storage

The crew then estimates how much storage volume or surface area is actually available at the retrofit site. To compute available storage, the retrofit crew should revisit its earlier estimate of available treatment area (i.e., the retrofit footprint drawn on the field map). The crew then determines the maximum depth of the proposed retrofit.

The maximum depth is normally set by the elevation of the storm drain or channel that the retrofit will discharge to as well as the average depth for the stormwater treatment option employed (Table 4.16). For ponds and wetlands, the retrofit crew may then use the following equation to estimate available storage:

$$V_{av} = 2/3 * d * SA$$

Where:

V_{av} = Available storage at the site (acre-feet)

d = Estimated max depth (feet)

SA = Surface area of the facility (acres)

$2/3$ = average volume factor

Available storage can also be estimated based on the typical surface area or depth requirements of different stormwater treatment options (Table 4.16). These simple rules assume treatment of a one inch rainfall and are used to quickly gain a sense of the surface area needed for water quality treatment.

Task 3c. Choose the Best Treatment Option

The crew concludes by prescribing the best combination of stormwater treatment options for the retrofit site that maximizes removal of the pollutant of concern, minimizes construction cost and addresses major site constraints (Figures 4.8 and 4.9). More guidance on stormwater treatment options can be found in Chapter 3 and Appendix I.

Task 4: Evaluate Retrofit Site Constraints

The crew inspects the site to look for possible feasibility constraints for the proposed retrofit. Potential constraints vary depending on the retrofit location and stormwater treatment options employed.

However, the crew should always look for the following general constraints:

- *Adjacent Land Uses:* The crew should observe current land use and activities within and adjacent to the proposed retrofit. Often, retrofits are rendered infeasible due to competing uses (e.g., the available treatment area is already being used as a dog park, ball field or overflow parking area; Figure 4.10). In one case, an otherwise great retrofit site was eliminated because it was needed for an emergency helicopter landing area for an adjacent hospital.
- *Conflicts with Existing Utilities:* The crew should walk the site looking for surface indicators of dry or wet underground utilities. Figure 4.11 illustrates some common indicators for sanitary sewers, water lines, gas, electric, and cable utilities. The crew should not forget overhead utilities, as tree growth in some retrofits could create future conflicts. The approximate location and depth of any utilities should be noted on the concept sketch to help the crew get more precise information when they return to the office.

Table 4.16: Drainage Area – Surface Area Relationships		
Stormwater Treatment Option	% of Contributing Drainage Area	Average Depth (ft)
Dry ED Ponds	1 to 3%	6
Wet Pond	1 to 3%	6
Constructed Wetland	3 to 5%	2
Bioretention	5 to 10%	1-2
Sand Filters	0 to 5%	2
Infiltration	0 to 5%	1-2
Swales	5 to 15%	2
Filter Strips	5 to 15%	1
Other Retrofits		
Dry wells	Each dry well can treat 500 sf of roof	1
Rain barrel (50 gal)	Max area draining to rain barrel 500 sf	3-5
Cistern (500 gal)	Max area draining to cistern 1000 sf	5-10
Planter boxes	Max area draining to box 15,000 sf	1.0
Green roofs	1 to 1 ratio of impervious area treated	0.5
Permeable pavers	1 to 1 ratio of impervious area treated	0
Rain gardens	10% of rooftop area	1

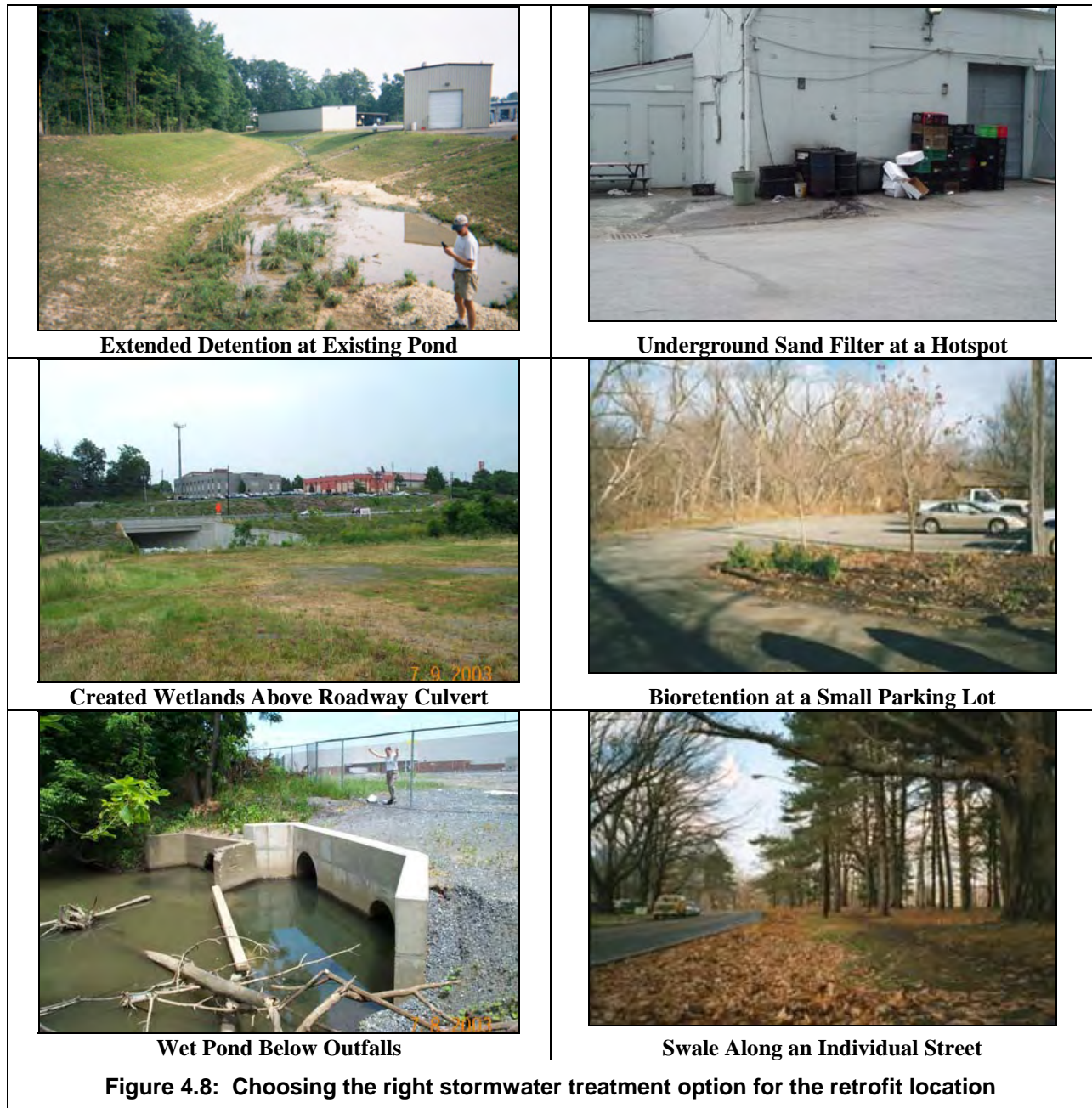





Figure 4.10: The potential retrofit location (left) may be eliminated since it is used as recreational space in conjunction with the adjacent playground.

- *Construction and Maintenance Access:* The crew should check whether heavy equipment can access the retrofit site during construction and future maintenance operations. The crew should look for the best point of entry and note its width and slope. Good maintenance access is defined as the ability to access proposed inlets, outlets and forebays from a paved road that has a slope no greater than 12% and a width of 12 to 20 feet. The access should permit vehicles to turn-around and be vested as a permanent easement. The crew should note whether retrofit constraints would interfere with existing traffic or parking lot use.
- *Wetland, Floodplain and Forests:* Crews should always try to anticipate potential environmental permitting issues related to any wetlands, floodplains, mature forests or stream channels present at the site. Ideally, the crew should have some experience in plant identification, and indicate whether any follow-up surveys might be needed for future permitting. The crew should also note the presence of any invasive plants that might

influence how the vegetation will be managed at the retrofit site.

- *Soils:* The crew can use a soil auger or screw driver to get a general sense of how underlying soils will influence retrofit design and construction costs. The crew should look for signs of compaction, poor infiltration, shallow bedrock, or a high water table. The soils analysis will be cursory, but should allow the crew to determine if more detailed soil or geotechnical investigations will be needed to support retrofit design.

Task 5: Complete Field Sketch and Notes

Space is provided on the RRI form for sketches and notes. The crew should sketch a plan view of the proposed storage retrofit and adjacent areas (Figure 4.12). The plan view should include both existing and proposed site conditions, drainage paths, and stormwater conveyance system. A profile view may be sketched for more complex storage retrofits and for on-site retrofits where elevations are tight, available head is limited, or existing storm drain inlets and outlets may present design challenges down

the road. Rough cross sections should also be sketched for unique retrofit design elements, such as weirs, risers, and flow splitters. The goal of the sketch is to provide enough information to fully convey all aspects of the proposed retrofit so that another designer could pick it up and proceed with final concept design.

For on-site retrofits, a plan view sketch of the entire site is usually warranted if multiple retrofits are proposed for the same site. In some cases, a generic concept sketch can be substituted when many similar on-site retrofits will be installed (e.g., rain gardens installed in multiple homes in a particular neighborhood). The narrative that accompanies the generic concept sketch design should note any design adaptations to consider during implementation and recommend the best delivery mechanism to make it happen.

Task 6. Finalize RRI Forms Back in the Office

The retrofit crew normally finalizes the RRI form back in the office. The crew often needs more information to complete the field concept, evaluate its feasibility and determine if another restoration project is more appropriate for the site. Crews often suffer from fatigue after field work and may put off finishing the RRI form or doing quality control. As time elapses, however, crews forget important site details and may have a hard time translating the field sketch into a good concept design. Crews should finalize the RRI form while it is still fresh in their minds using the following punchlist of common quality control issues:

- *Confirm property ownership for the site:* Consult parcel data or local databases to determine ownership at each retrofit

location, and obtain landowner contact information.

- *Confirm drainage area:* Site-specific mapping data, such as storm drain maps, pond design calculations, or fine-scale topo are used to get a final accurate estimate of the contributing drainage area to the retrofit.
- *Confirm drainage area impervious cover:* Aerial photography, planimetric GIS data or impervious cover coefficients can provide a good estimate of impervious cover.
- *Analyze utility and soil maps:* Site-specific utility maps should be consulted to confirm the available treatment area is actually suitable for retrofitting. Refer to local soils maps to get a general sense of soils at the site.
- *Complete concept design sketch:* A final plan and profile view of the proposed retrofit should be drawn to scale so that accurate numbers can be computed for the actual retrofit storage volume. Most concept sketches should be redone on two-foot contours, and the team leader should make sure any missing elements from the field recon are added.
- *Confirm volume computations:* In many cases, either the target or available storage volume may change as a result of the preceding steps. Therefore, the team leader should always review the final retrofit volume computations.
- *Review existing stormwater practice as-built drawings:* If these drawings are available, they are a great design resource for pond and conveyance retrofits since they provide valuable details on the workings and purpose of

stormwater practices that are complex, overgrown or hard to access.

- *Confirm storm drain invert elevations:* If detailed storm drain maps are available, it is useful to confirm spot elevations. It doesn't matter if these maps are old and non-digital, as they contain more precise elevation data than shown on GIS. Make sure, however, to use consistent topographic benchmarks.

The retrofit team then makes a final recommendation on whether the site is suitable to proceed to concept design. Generally, a decision to stop is made when a site is severely constrained or cannot meet the walkaway volume. A feasible retrofit should not be eliminated from consideration until the retrofit ranking process is completed. In the event that a retrofit is not feasible, the RRI form provides space to suggest an alternative restoration project (Table 4.17).



Figure 4.11: Examples of Some Common Utility Indicators

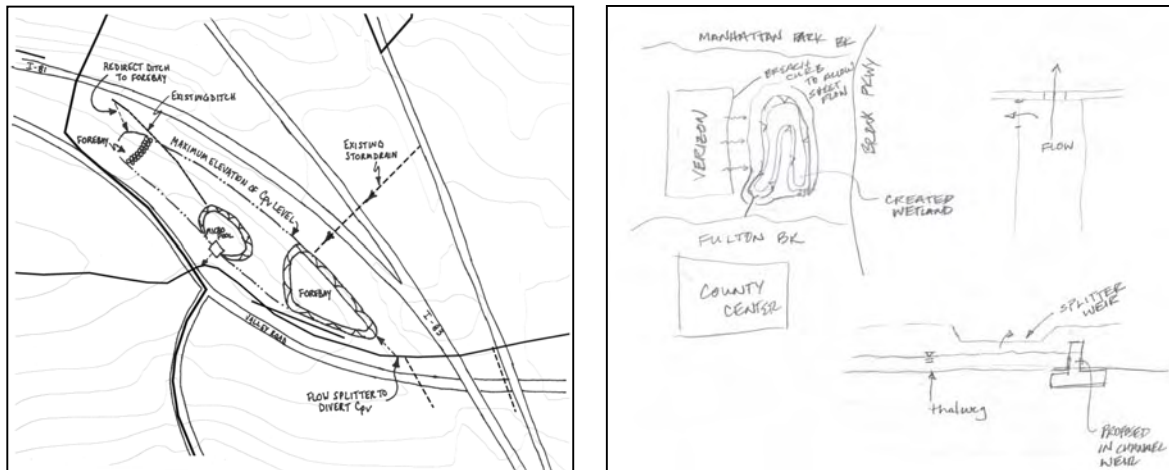

Figure 4.12: Examples of Retrofit Field Sketches

Table 4.17: Alternative Restoration Projects to Consider When Retrofit Is Not Feasible	
Storage Retrofits	On-Site Retrofits
<p>SR-1: Existing Ponds</p> <ul style="list-style-type: none"> • Reforest pond and its buffer • Plant wetland plant species in benches • Notify owner to perform maintenance • Designate for local Adopt-a-Pond program <p>SR-2: Above Roadway Culverts</p> <ul style="list-style-type: none"> • Upstream wetland restoration • Culvert repair or replacement • Fish barrier removal • Downstream stream repair • Riparian reforestation • Stream adoption <p>SR-3: Below Outfalls</p> <ul style="list-style-type: none"> • Outfall stabilization • Stream daylighting • Riparian reforestation <p>SR-4: In the Conveyance System</p> <ul style="list-style-type: none"> • Natural channel design • De-channelization • Riparian reforestation • Wetland restoration <p>SR-5: In Transport Right-of-Way</p> <ul style="list-style-type: none"> • Reforestation • Spill controls <p>SR-6: Large Parking Lot</p> <ul style="list-style-type: none"> • On-site parking lot retrofits • Reforestation • Pollution prevention practices • Regular vacuum sweeping and litter control 	<p>OS-7: Hotspot Operations</p> <ul style="list-style-type: none"> • Pollution prevention • Spill prevention and response • Secondary containment <p>OS-8: Small Parking Lots</p> <ul style="list-style-type: none"> • Tree planting • Vacuum sweeping and litter control • Parking lot pollution prevention practices <p>OS-9 Individual Streets</p> <ul style="list-style-type: none"> • Street sweeping • Storm drain cleanouts • Storm drain marking • Commercial pollution prevention practices <p>OS-10 Individual Rooftop</p> <ul style="list-style-type: none"> • Watershed education • Neighborhood stewardship practices • Reforestation <p>OS-11 Little Retrofit</p> <ul style="list-style-type: none"> • Reforestation • Erosion Repair <p>OS- 12 Landscape/Hardscape</p> <ul style="list-style-type: none"> • Reduced fertilizer and pesticide use • Use of native plants • Urban forestry practices • Smart site practices for redevelopment <p>OS-13 Underground</p> <ul style="list-style-type: none"> • Intensive street sweeping • Regular cleanouts of storm drain inlets • Pollution prevention practices • Detection and elimination of illicit discharges

Step 4: Compile the Retrofit Inventory

This step produces concept designs for individual retrofit sites, and compiles them in a retrofit inventory for the entire subwatershed, in three simple tasks:

Task 4.1: Prepare Storage Retrofit Concept Designs

After the field investigation, the team prepares a concept design to assess retrofit feasibility and compare it against other proposed retrofits for the subwatershed. A concept design for a storage retrofit is neither a final design nor a detailed construction drawing. Concept designs are often expressed as a percentage of effort to get to final design. At this stage of the retrofit process, a 15% design is usually sufficient, but a 30% design may be needed for larger or more complex storage retrofit projects. A 15% design consists of a decent sketch, an analysis of project feasibility, storage calculations, pollutant load reduction estimates and planning-level construction cost estimate. A 30% design has more detailed engineering computations and some preliminary hydrology and other modeling to determine the size and feasibility of the retrofit.

The design team begins by analyzing the final RRI form for the storage retrofit. The designer then appends additional items to complete the concept design:

Project Feasibility: Designers should outline the specific hurdles needed to actually implement the retrofit by specifically referencing the type and number of environmental permits needed, landowner approval or easements that must be secured, special engineering studies needed to support final design and any access issues

that may complicate retrofit construction. The designer should also indicate the probability of acceptance by neighbors or the landowner.

Storage Calculations: Designers should present their final calculation of the target WQ_v storage for the retrofit and confirm its actual storage volume (in acre-feet).

Pollutant Removal Rate: Designers can compute the pollutant load delivered to the retrofit using the Simple Method (taking input parameters directly from the RRI form). Next, designers adjust the median removal rate for the pollutant of concern, based on a review of site conditions and design factors for the individual retrofit using the design point method. Appendix B provides detailed guidance on how to perform both calculations. The final product is a pollutant removal estimate expressed in terms of lbs/year.

Initial Cost Estimate: A preliminary cost estimate can be derived based on impervious area treated using the retrofit unit cost data presented in Chapter 2. All cost estimates should be adjusted for any unusual site factors that might drive up construction costs. Designers should also indicate whether any of the following factors will be need to be addressed to construct the retrofit:

- Land acquisition
- Poor construction access
- Hauling material off-site
- Utility relocation
- Multiple environmental permits

Task 4.2: Finalize On-Site Retrofit Delivery Methods

Concept designs for on-site retrofits are slightly different. They are primarily intended to show how on-site retrofits can be delivered on a widespread basis over a neighborhood or specific land use. The designer should estimate the number of homes, yards, businesses or other individual units where the on-site retrofit could potentially be applied across the subwatershed. For example, Neighborhood Source Assessment data can estimate the number of residential rooftops that could be treated or disconnected. The remainder of an on-site concept plan consists of the following sections:

Generic Sketch: A final generic concept design drawing of the basic on-site retrofit approach should be prepared, along with notes on any site-specific constraints that may require minor design adaptations.

Delivery Mechanism: Designers should describe the proposed delivery mechanism for the proposed on-site retrofit, such as resident education, direct technical assistance, workshops, door-to-door outreach, free construction materials or financial incentives. Profile Sheets OS-10 and OS-11 provide specific guidance on potential delivery mechanisms for common on-site retrofits.

Target Implementation Rate: Designers should estimate a realistic rate of adoption or implementation for the on-site retrofit, which is obviously linked to the delivery mechanism selected.

Aggregate Pollutant Removal: The team then estimates the aggregate pollutant load treated by individual on-site retrofits, and selects a reasonable pollutant removal rate to

determine the total pollutant load reduction. Table 4.18 presents an example of how to estimate pollutant removal through the delivery of rain gardens in three residential neighborhoods.

Aggregate Treatment Costs: The same scaleable process can define the aggregate cost for on-site retrofits (Table 4.19). Designers estimate unit costs for each individual installation and retrofit delivery, and then scale up at the neighborhood level. In the rain garden example, the combined cost for retrofit installation and delivery is nearly \$20,000 per impervious acre treated, or about \$13,250 per pound of phosphorus removed.

Task 4.3 Assemble the Retrofit Inventory

Three simple tasks are performed to compile an inventory of all stormwater retrofits that can be implemented in a subwatershed:

1. *Conduct final quality control on individual retrofit concept designs:* Final project concept designs should be reviewed one last time for accuracy and thoroughness, preferably by someone not on from the original field crew. The team leader should ensure that all field forms, digital photos, sketches, field notes, and other project data are organized into a single project folder. Individual retrofit concepts are then finalized in the form of a two to four-page retrofit summary that includes the feasibility assessment, sketch, narrative and initial cost estimate.
2. *Assemble the retrofits into a master binder and spreadsheet or GIS:* Individual retrofit summaries are then assembled into a master binder (Figure 4.13). A spreadsheet can be created that organizes retrofits by their unique site

ID, impervious area treated, retrofit location, stormwater treatment option prescribed, pollutant reduction and cost. The spreadsheet may also serve as an index for corresponding section of the master binders. When completed, the master binder serves as the subwatershed retrofit archive.

3. Produce a subwatershed retrofit locator map and inventory summary table. The front-end of the retrofit inventory should contain a subwatershed retrofit locator map to organize retrofit data needed for evaluation and ranking (Figure 4.14).

Table 4.18: Example of How On-site Pollutant Removal Is Computed

Neighborhood	Total # of Rooftops	Roofs Treated ¹	Total IC (acres) ²	Total TP Load (lbs/yr) ³	Removal Rate ⁴	TP Reduced ⁵
A	200	25%	0.91	2.12	65%	1.38
B	500	40%	4.59	10.69	65%	6.95
C	300	30%	2.29	5.34	65%	3.47
Total	1,000	-	7.79	18.15	-	11.80

Notes:
¹ Assumes aggressive delivery program using door to door outreach, direct technical assistance and homeowner financial incentives
² Assumes 1,000 square feet of rooftop treated in rain garden per house
³ Total P using Simple Method: C = 0.30, P = 40 inches, Rv = 0.95
⁴ Median bioretention TP removal rate in Chapter 3
⁵ pounds of TP removed per year

Table 4.19: Deriving Neighborhood Scale Cost Estimates for On-site Retrofits

Neighborhood	# Rooftops Treated ¹	Unit Costs (Per Home) ²	Delivery Cost ³	Total Cost ⁴
A	50	\$ 350	\$ 75	\$ 21,250
B	200	\$ 350	\$ 125	\$ 95,000
C	100	\$ 350	\$ 50	\$ 40,000
Total	350	-	-	\$ 156,250

Notes
¹ Each 1,000 sf of roof produces 83 cubic feet of runoff
² Assume volunteer rain garden installation @ 4.00 cf with 5% Design & Engineering
³ Unit cost for different retrofit delivery programs (per house)
⁴ Total cost for installation and delivery for 350 homes

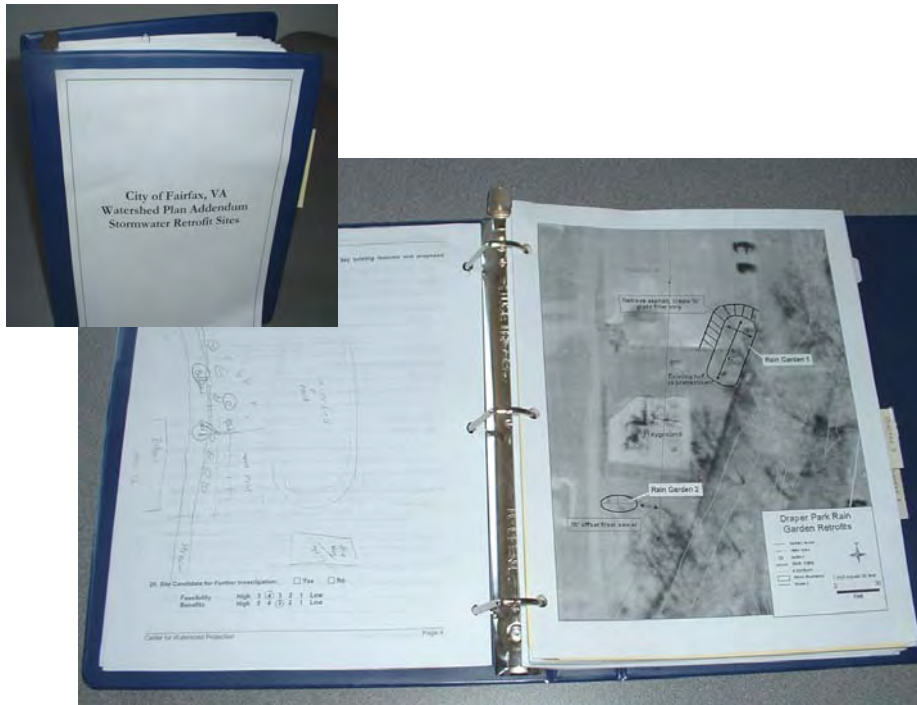

Figure 4.13: This binder was used to keep all completed retrofit forms, preliminary concept designs and a table of all retrofit sites visited.

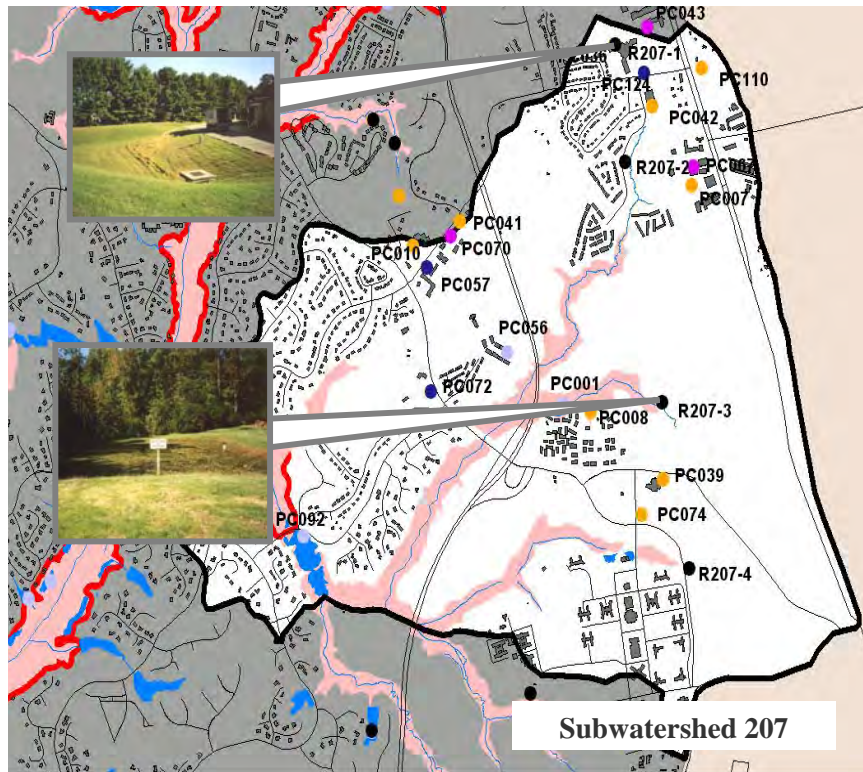

Figure 4.14: Example of a retrofit locator map created for a subwatershed retrofit archive.

Step 5: Rank the Proposed Retrofits

The next step involves prioritizing the best retrofits for future implementation. Since most communities have limited capital budgets for retrofit design and construction, they need a prudent and cost effective strategy to guide implementation. The ranking process involves three basic tasks:

- 5.1. Consult neighbors and stakeholders to get project input
- 5.2. Choose retrofit screening criteria
- 5.3. Create a retrofit priority list

Task 5.1 Consult Neighbors and Stakeholders to Get Project Input

Storage retrofits can significantly alter the local landscape, and neighbors and landowners often have many real or perceived concerns about retrofit practices. It is wise, therefore, to get neighborhood input before costly field surveys and engineering studies are performed for retrofits that may get dropped later because of community opposition.

Every storage retrofit recommended for final design and permitting should be presented to the public at least once. Residents who are informed in advance about the benefits of retrofitting are more likely to accept projects. Consequently, it is important to give them an early opportunity to comment on proposed retrofits and respond to their concerns prior to final ranking and project design. Some of the more common concerns residents express are that storage retrofits will:

- Result in the loss of existing trees
- Increase unwanted public access to their backyards

- Pose safety risks for children, such as drowning in deep pools
- Create mosquito breeding conditions and increase potential for West Nile Virus
- Attract vermin, snakes, or rats
- Produce ragweed and other plants that cause allergies
- Become a poorly maintained eyesore
- Cause noise and neighborhood disturbance during construction
- Detract from property values
- Eliminate an existing public or private use of open land
- Waste taxpayer money that could be spent elsewhere in the community

The retrofit team should anticipate these concerns and be ready to respond to them in an even-handed manner. Table 4.20 outlines common perceptions, realities and design responses for many common retrofit concerns. These objections should never be ignored or glossed over since many residents are already somewhat suspicious of local government.

Neighborhood consultation is normally scheduled in the evening to coincide with a regular homeowner or civic association meeting (Figure 4.15). The meetings should



Figure 4.15: Landowner concerns can be addressed during neighborhood consultation meetings.

clearly explain exactly what is being proposed, what will happen during construction, and what the retrofit will look like when finished. Subwatershed maps, project renderings, and photos of similar storage retrofits can all help show residents what to expect.

The meeting should also include a presentation on why retrofits are needed and the planning process that led to the proposed retrofit. Neighborhood meetings are also an excellent way to educate residents about neighborhood pollution sources, stewardship practices and available municipal stewardship services. Most of all, the meeting should be structured to give adjacent residents the opportunity to voice their concerns, issues and questions about the retrofit. Additional tips on conducting effective neighborhood consultation meetings can be found in Profile Sheet 19 in Manual 2.

Task 5.2 Choose Retrofit Screening Factors

The next task chooses the best combination of screening factors to compare individual retrofit project concept designs (see Table 4.21). The screening factors should allow a direct and fair comparison among both storage and on-site

retrofits in a subwatershed. Next, a relative weight is assigned to each screening factor that reflects its perceived influence on retrofit project success. Then, the retrofit team then analyzes the range of scores among all retrofits to determine the scoring rules that will be used to award or deduct points from individual projects.

Task 5.3: Create Retrofit Priority List

The design team pulls pertinent information from the retrofit inventory to score individual retrofit projects according to the scoring system developed in the preceding task (Figure 4.16). Individual project scores are entered into a spreadsheet and totaled. Project scores are then ranked from highest to lowest to establish the retrofit priority list. High scoring projects should be double-checked to look for hidden “project killers.” This occurs when a retrofit project has a high total score, but has a low or zero score for one or more individual screening factors (suggesting that it is hard to implement). Examples of stormwater retrofit ranking factors are provided in Table 4.22. The application of a scoring system to a hypothetical group of retrofit projects is shown in Table 4.23.

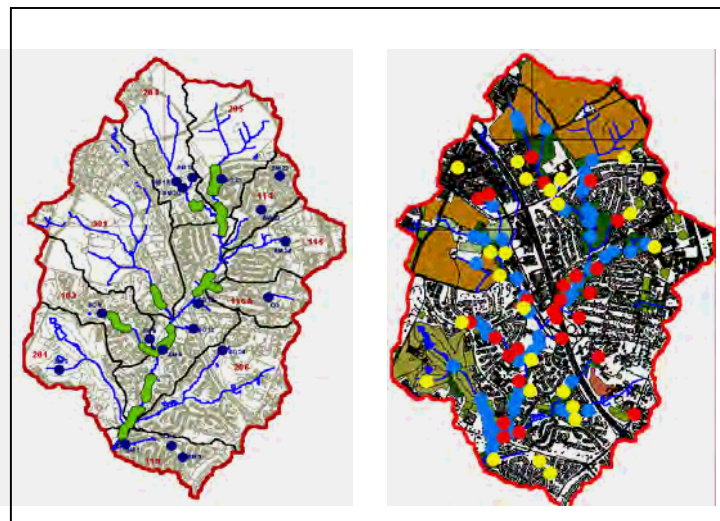

Figure 4.16: Scoring helps identify priority retrofit sites (left) from all potential retrofit sites visited (right)

Table 4.20: Perception, Reality, and Response to Common Neighborhood Concerns about Storage Retrofits			
Perception	Reality	Potential Design Responses	Supporting Resources
Loss of Mature Trees	<i>High with poor retrofit layout</i>	Survey trees prior to layout...Fingerprint retrofit around mature tree...Specify tree protection measures during construction Reforest at least 2:1 for cleared trees.	Cappiella <i>et al.</i> (2006a)
Drowning	<i>Low: w/ proper design</i>	Use shallow wetlands rather than deep pool...Safety and aquatic benches around micropools and forebays...Side-slope controls in pond buffer...Fence sharp drop offs	Marcy and Flack (1981); Jones and Jones (1982); Eccher (1991)
Mosquitoes	<i>Low to Medium: depending on design</i>	Aquatic benches... Deeper pools ... Stock w/ <i>Gambusia</i> if native...Avoid undersized retrofits...Avoid stagnation...Education about mosquito habitat...Regular maintenance including mosquito management...Mowing and removal of overgrown wetland vegetation	Schueler (1995b); Hunt and Lord (2006b); Hunt <i>et al.</i> (2005); Santana <i>et al.</i> (1994); Ladd and Frankenburg (2003); Walton (2003)
Vermin (ticks, rats, snakes)	<i>Low</i>	Regular mowing of publicly used areas. Manage to grow into forest	Hunt and Lord (2006b) Cappiella <i>et al.</i> (2006b)
Odors	<i>Medium</i>	Avoid under-sized retrofits in residential areas...Keep constant inflows...Install aeration devices or fountains...Remove dead algae and rooted plants as part of maintenance...Increase pond depth	
Looks Ugly	<i>Low to Medium</i>	Pondscaping...Involve landscape architect in retrofit design...Irregular shorelines...Increase landscaping budget...Minimize concrete surfaces and paint risers...Tree conservation...Screening plantings...Reforestation	Schueler, 1992; MDE (2000); Echols and Pennypacker (2006); France (2003)
Vegetation Growth	<i>Medium</i>	Regular mowing...Allow trees to grow in pond buffer...Landscape maintenance contracts	Hunt and Lord (2006b)
Maintenance	<i>High</i>	Defined maintenance agreements...Designate retrofit in adopt-a-pond...Public maintenance	NVPDC (2000) and Sturm (2003), CWP (2004b)
Trash/Debris	<i>High</i>	Wetland benches...Annual shoreline cleanups...Enforcement of illegal dumping/littering	Hunt and Lord (2006b)
Property Values	<i>Low</i>	Well designed wet ponds and wetlands increase property value (dry ponds they replace decrease property value)	Emerling-DiNovo (1995); Land and Water (1996); Schueler (1995a)
Polluted Sediment	<i>Low</i>	Assess upland hotspot uses before design. Install pretreatment...Include spill containment...Offsite sediment disposal...Resident education...No swimming signs	Hey and Schaefer (1983); Dewberry and Davis (1990); Yousef and Lin (1990); Schueler (1994a)
Lost Community Uses	<i>Med to High</i>	Ask neighbors about how the parcel is used...Check out site on a weekend to see how it is being used	
Bad Neighbor	<i>Low</i>	Incorporate trails, interpretive signs, gazebos, benches and monitoring into the design	
Construction Issues	<i>Medium</i>	Incorporate measures into construction contracts...Weekday construction...Silence vehicle back-up alarms...Noise suppression enclosures on equipment...Close engine housing panels...Stringent ESC controls...Traffic and parking management	
Resident Geese	<i>Medium to High</i>	Minimize turf cover in retrofit buffer...Use stormwater wetland...Install aquatic benches...Place a grid of string across the pond to prevent easy landing...Let neighborhood dogs roam	Hunt and Lord (2006); Rodewald (2001) Schueler (1992)

Table 4.21: Examples of Potential Retrofit Screening Factors

<p>Cost Per Treated Area: This screening factor expresses cost in terms of the acres of impervious cover treated by the retrofit, and is preferred to total construction cost since it allows storage and on-site practices to be directly compared.</p>
<p>Cost Per Pollutant Removed: If pollutant reduction is the primary retrofit objective, projects should be screened based on the relative cost to remove pollutants. This requires a little more analysis to compute pollutant loads delivered to the retrofit site using the methods in Appendix B and then adjusting them based on the expected pollutant removal rate for the retrofit.</p>
<p>Stream Channel Protection Capability: If stream channel protection is a primary retrofit objective, this factor rates how the retrofit will help to reduce channel erosion through either storage of the channel protection volume or runoff reduction.</p>
<p>Compatibility with Core Subwatershed Objective: This factor rates how well the proposed retrofit conforms to the core retrofitting objective for the subwatershed. Maximum points are awarded for retrofits that directly support all objectives (e.g., provide maximum removal of pollutant of concern). Fewer points are awarded for retrofits that only indirectly support subwatershed objectives, and no points are awarded if the retrofit does not address subwatershed objectives in a meaningful way.</p>
<p>Maintenance Burden: Retrofit projects differ greatly in their long-term maintenance burden. The long-term maintenance needs of each retrofit should be assessed and points deducted if vegetation management, sediment removal and clogging are expected to be problems. Points may also be deducted if maintenance is not clearly vested with a responsible party.</p>
<p>Landowner Cooperation: This screening factor rates the willingness of private or public landowners to allow the retrofit to be installed on their property. Points are deducted for projects where permission is uncertain, easements must be secured, or landowners are uncooperative.</p>
<p>Permitting Burden: Some retrofit projects require many different permits and approvals before ground can be broken. In many cases, permitting agencies may require special studies, impose costly permit conditions, or disapprove the project altogether. Points are deducted for projects subject to multiple permits or to a single difficult permit (e.g., wetlands disturbance).</p>
<p>Synergy with Other Restoration Practices: This factor evaluates whether the retrofit can be integrated with other restoration practices at the same site or stream reach to maximize restoration benefits. An example would be a storage retrofit located above a stream restoration project.</p>
<p>Neighborhood Acceptance: This factor ranks the community acceptance of the retrofit based on feedback from neighborhood consultation meetings. Points are deducted for controversial projects, or for situations where concerns are raised about safety, forest loss, aesthetics, public access, construction noise and impact on property values. Maximum points are awarded for projects that get enthusiastic neighborhood support and have prospects for actual community involvement during construction or maintenance.</p>
<p>Access: This factor assesses the ability to get heavy construction equipment to the retrofit site for construction and maintenance. Points are deducted for sites with steep or unstable side-slopes, where construction access disrupts neighbors, when significant tree clearing is required, or when easements for access or maintenance must be secured from a private landowner.</p>
<p>Use of Innovative Practices: Some retrofits are preferred because they utilize an innovative design or technology that has not yet been implemented in the community. These projects are often awarded extra points because of their demonstration value.</p>
<p>Partnership Opportunities: This screening factor awards points based on the number of potential restoration partners that may be involved in project implementation. Projects with many partners or a new partner are normally awarded more points since they can leverage resources available for future retrofits.</p>
<p>Public Visibility: This factor examines the visibility and potential education value of the proposed retrofit. Points are awarded for projects that have public access, experience heavy use, are linked to trails and bikeways or have opportunities for signage and education. Points are deducted for projects situated on private land, out of view or restricted or prohibited access.</p>
<p>Habitat Creation: This factor evaluates whether the retrofit can create new terrestrial or aquatic habitat features or connect existing habitat features. Maximum points are awarded for projects that emphasize wetland, vernal pool, forest, or in-stream habitat creation.</p>
<p>Other Community Benefits: This factor is a sort of grab bag that evaluates the retrofit with respect to any additional community benefits it may provide (recreation, increased property values, education, open space, trails, greenways, neighborhood revitalization, etc.).</p>

Table 4.22: Example Stormwater Retrofit Ranking Criteria		
Stormwater Retrofit Ranking Criteria (35 Total Points Possible)		Possible Points
1.	Impervious Area Treated Less than 100 acres 101-250 acres Greater than 250 acres	5 [1] [3] [5]
2.	Water Quality Target	10
a.	Runoff Depth Treated (inches per impervious acre) Less than 0.25 0.26 - 0.50 0.51 - 1.00	5 [1] [3] [5]
b.	TP Pollutant Load Reduction Less than 20% 21% to 49% 50% or more	5 [1] [3] [5]
3.	Planning Level Construction Cost (per acre of drainage area) Greater than \$10,001 \$5,00 to \$10,000 \$2,501 to \$5,000 \$1,001 to \$2,500 Less than \$1,000/acre	5 [1] [2] [3] [4] [5]
4.	Ownership Assumed Private Public	5 [0] [5]
5.	Access Poor Good Excellent	5 [1] [3] [5]
6.	Project Visibility Poor (site is on private property or cannot be seen from the street) Good (site adjacent to a street) Excellent (site adjacent to a highly traveled street or public property)	5 [1] [3] [5]

Table 4.23: Example Stormwater Retrofit Prioritization															
ID	Ranking Factors														
	Impervious Area Treated		Runoff Depth Treated		Pollutant Load Reduction		Planning Level Cost		Ownership		Construction Access		Project Visibility		Total Points
	(ac)	(pts)	(in / imp ac)	(pts)	(adjusted RR)	(pts)	(per ac)	(pts)		(pts)		(pts)		(pts)	(pts)
R-17	2.9	1	0.5	3	55	5	\$8,070	2	Public	5	Excellent	5	Excellent	5	26
R-03	413.3	5	0.5	3	15	1	\$200	5	Private	0	Excellent	5	Excellent	5	24
R-08	0.3	1	0.5	3	65	5	\$14,700	1	Public	5	Good	3	Excellent	5	23
R-02	2.7	1	1.0	5	35	3	\$8,430	2	Private	0	Excellent	5	Excellent	5	21
R-16	6.5	1	0.5	3	60	5	\$7,260	2	Private	0	Excellent	5	Excellent	5	21
R-18	159.8	3	0.5	3	10	1	\$330	5	Private	0	Excellent	5	Good	3	20
R-06	11.7	1	1.0	5	15	1	\$1,950	4	Private	0	Excellent	5	Good	3	19
R-04	264.2	5	0.1	1	40	3	\$80	5	Private	0	Poor	1	Poor	1	16
R-05	7.0	1	1.0	5	60r	5	\$15,000	1	Private	0	Good	3	Poor	1	16

Step 6: Conduct a Subwatershed Treatment Analysis

Subwatershed treatment is defined as the proportion of subwatershed area that is effectively treated by stormwater retrofits. In simple terms, it refers to the fraction of subwatershed area (or impervious area) served if all proposed retrofits are built. A Subwatershed Treatment Analysis (STA) evaluates whether the proposed combination of stormwater retrofits can achieve enough treatment to meet subwatershed restoration objectives. The STA requires the use of the Watershed Treatment Model (Caraco, 2001) or a similar model to estimate the reductions in the pollutant of concern. Detailed guidance on performing an STA is provided in Manual 2. The retrofit inventory should contain all of the information needed to support an STA, so it can be done in three short tasks.

Task 6.1 Compute Pollutant Removal by Storage Retrofits: This task computes the aggregate pollutant reduction achieved by individual retrofit projects at the subwatershed level. The pollutant removal estimates developed for the final concept designs can be directly inserted into the WTM to compute the cumulative benefit of the proposed suite of retrofits.

Task 6.2 Compute Pollutant Removal by On-site Retrofits: A similar approach is used to determine pollutant load reduction benefits for on-site retrofits. Once again, the design team consults the on-site retrofit concept designs, and estimates the total contributing drainage area treated in the subwatershed using the scaling methods outlined in Step 4. In some cases, a further discount in pollutant removal is needed to prevent double counting (e.g., on-site retrofit located above downstream storage retrofit).

Task 6.3: Compare Subwatershed Results to Restoration Objectives: The STA quickly computes whether the proposed suite of retrofits can achieved the pollutant reduction goals established in the scoping phase. In most cases, the initial list of priority retrofits will fall short of the mark. In this event, the team can re-prioritize retrofits, propose more retrofits (e.g., on-site retrofits), look for addition pollutant reductions via pollution source controls or discharge prevention, or revise subwatershed objectives.

An example of how to calculate an STA for a hypothetical watershed is shown in Figure 4.17. The community seeks to reduce pollutant load by 25% to restore an urban lake. The design team proposes retrofitting the 4.5 square mile subwatershed with four storage retrofits and on-site retrofits in one target neighborhood. The proposed retrofits capture drainage from 1,379 acres and treat 62% of subwatershed impervious cover. For

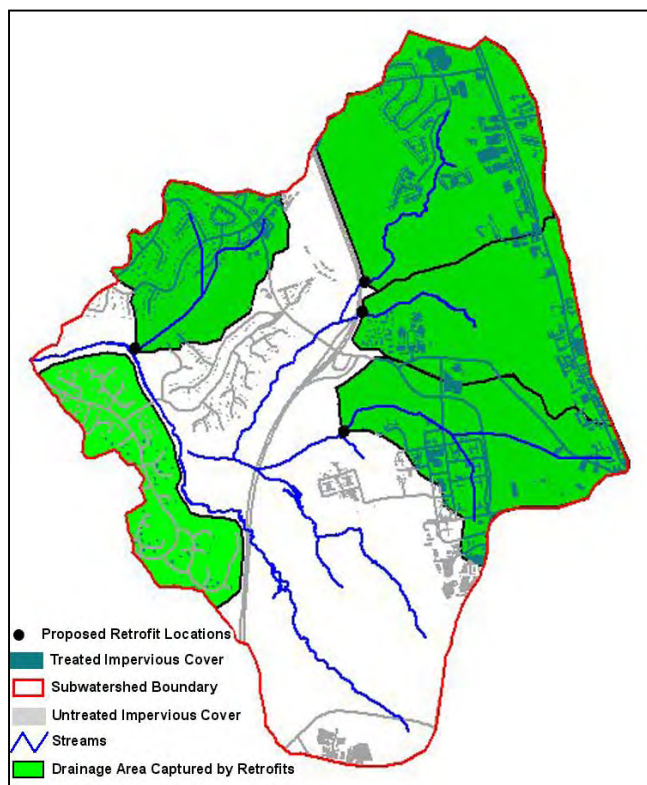

Figure 4.17: Subwatershed Treatment Analysis Example

each proposed retrofit, the drainage area, imperviousness, and pre-retrofit pollutant load were calculated, as shown in Table 4.24. The retrofit team then inserted adjusted removal rates based on the design point method for each individual retrofit project and performed an STA for the subwatershed as a whole. Based on the results, the team concluded that the proposed retrofits were capable of reducing pollutant loads by 251 lbs/yr. Given the total subwatershed loading of 789 lbs/yr, this produced an expected subwatershed pollutant reduction of about 32%, which exceeded the target reduction goal.

Step 7: Final Design and Construction

The final step of retrofit implementation involves design and actual construction. Costs involved in final design and permitting of storage retrofits may range from 32 to 50% of base construction cost.

The process of constructing a retrofit involves five tasks:

- 7.1 Secure Environmental Permits
- 7.2 Obtain Landowner Approvals and

- Easements
- 7.3 Perform Special Engineering and Surveying Work to Support Design
- 7.4 Put Together the Design Package
- 7.5 Contract and Construction Management

Task 7.1 Secure Environmental Permits

Permitting issues for storage retrofits can involve impacts to existing wetlands, forests and floodplains. Table 4.25 provides a summary of typical surveys needed for environmental permits. While good designers try to avoid or minimize impacts, some are unavoidable to meet reasonable storage targets. Permitting agencies will scrutinize the project to make sure impacts are minimized and are clearly outweighed by the expected environmental benefits of the proposed retrofit. Designers should take a step back and be their own worst critic – this is often when ethical designers choose to walk away from a proposed retrofit because it may do more harm than good. Designers will always need to use their best professional judgment to balance potential impacts that are hard to predict against the benefits to be provided by the retrofit.

Table 4.24: Computation of Storage and On-Site Retrofits

Unique Site ID	Stormwater Treatment Option	Drainage Area (acres)	Pre-Retrofit Pollutant Loading (lbs./year)	Median Pollutant Removal Efficiency (%)	Design Points	Adjusted Removal Efficiency (%)	Pollutants Removed (lbs)
R-1	Extended Detention	231	86.7	20	+ 1	25	21.7
R-2	Wet Pond	333	138.2	50	-3	40	55.3
R-3	Constructed Wetlands	485	214.0	50	+ 5	75	160.5
R-4	Extended Detention	325	27.0	20	+ 3	40	10.8
OS-1	Bioretention rain gardens at 50 houses	3.8	8.9	65	-1	30	2.7
	Untreated	1501	314	-	-	-	0
Total		2878	789				251 (32%)

Task 7.2 Obtain Landowner Approval and Easements

The retrofit team should never underestimate the time and effort involved in getting approvals to proceed with retrofit construction (Table 4.26). Approval issues are magnified when a retrofit is located on private property, or when easements must be secured for construction or maintenance access. Approvals are somewhat more manageable when the retrofit is located on public land, but still require a great deal of interagency coordination and negotiation. Most owners want to know the long-term maintenance arrangements for the retrofit and who will be the maintainer.

If property ownership or boundaries are in doubt, the designer should check with the local planning authority on plat requirements and review procedures and hire a survey crew to document property boundaries. Designers should not assume that property owners will be willing retrofit partners. Owners may need to be educated about retrofit benefits and offered some incentives to gain approval.

Task 7.3 Perform Special Engineering and Surveying Work to Support Design

A number of special engineering studies and field surveys are needed to directly support final design of retrofit projects. The exact type and number of surveys depends on the

complexity of the retrofit and site conditions. While these studies increase overall costs for project design, they help the designer anticipate potential construction problems, secure needed approvals, and ensure proper retrofit function. Some common engineering studies and field surveys associated with storage retrofits are shown in Table 4.27.

Task 7.4 Put Together the Design Package

Final design translates the retrofit concept into a construction drawing and specifications (Figure 4.18). Designers assemble a final design package, attached secured permits and approvals, and prepare bid documents to construct the retrofit project. The design package for retrofit projects incorporates the same elements used to construct stormwater projects at new development sites, including:

- Hydrologic and hydraulic modeling computations
- Detailed topographic mapping
- Property line establishment
- Site grading and earthwork estimates
- Structural design
- Geotechnical investigations
- Erosion and sediment control plans
- Construction sequencing and staging
- Planting plans
- Bid specifications

Table 4.25: Typical Environmental Permits Needed for Storage Retrofits						
Permits	SR-1 Pond	SR-2 Culvert	SR-3 Outfall	SR-4 Conveyance	SR-5 ROW	SR-6 Parking Lot
Wetland delineation	⊙	●	⊙	●	⊙	○
Wetland functional assessment	⊙	⊙	⊙	⊙	⊙	○
404 wetland permit	⊙	●	⊙	⊙	⊙	○
Forest stand delineation	⊙	●	⊙	⊙	⊙	⊙
Forest inundation analysis	⊙	●	⊙	○	○	○
Forest conservation permit	⊙	●	⊙	⊙	○	⊙
Fish passage survey	⊙	●	○	○	○	○
Section 401 WQC Permit	●	●	●	⊙	⊙	⊙
Floodplain alteration permit	⊙	⊙	●	⊙	○	○
Dam safety review permit	●	●	⊙	○	○	○
Local ESC Permit	●	●	●	●	●	●

Key: ● Frequently needed; ⊙ Sometimes needed; ○ Seldom needed

Table 4.26: Key Approvals and Easements for Storage Retrofits						
Approval or Easement	SR-1 Pond	SR-2 Culvert	SR-3 Outfall	SR-4 Conveyance	SR-5 ROW	SR-6 Parking Lot
Local SWM review	●	●	●	●	●	●
Highway approval	⊙	●	⊙	⊙	●	⊙
Park authority approval	○	⊙	⊙	⊙	○	⊙
Access easements	●	●	●	⊙	⊙	⊙
Expanded drainage easements	⊙	⊙	⊙	⊙	⊙	⊙
Maintenance escrow	⊙	⊙	⊙	⊙	⊙	⊙
Neighborhood consultation	●	⊙	⊙	●	○	⊙
Landowner notification	●	⊙	⊙	●	⊙	●

Key: ● Frequently needed; ⊙ Sometimes needed; ○ Seldom needed

Table 4.27: Special Engineering and Survey Work to Support Storage Retrofit Design						
Engineering or Survey Work	SR-1 Pond	SR-2 Culvert	SR-3 Outfall	SR-4 Conveyance	SR-5 ROW	SR-6 Parking Lot
Updated land cover in CDA	●	●	◎	◎	◎	○
Soil borings	●	●	●	●	●	●
Soil infiltration testing	○	○	◎	◎	◎	◎
Soil depth to groundwater	●	●	●	●	◎	◎
Site topo survey (1 ft)	●	●	●	●	●	●
Spot elevations and inverts	●	●	●	●	●	●
Hydraulic cross section of upstream channels/pipe	◎	◎	◎	◎	◎	○
Tailwater/backwater analysis	◎	◎	●	◎	◎	○
Floodplain analysis	◎	◎	◎	◎	○	○
Dam hazard analysis	●	◎	○	○	○	○
Culvert capacity	○	●	○	◎	○	○
Downstream channel stability	◎	●	◎	●	◎	◎
Easement research	●	◎	◎	●	◎	●
Utility surveys	●	●	●	●	●	●
Traffic studies	○	◎	○	○	●	◎
Parking demand studies	○	○	○	○	○	●
Discharge investigation	◎	◎	●	◎	○	○
As-built conditions	◎	◎	◎	◎	◎	◎
Existing H&H routing	●	●	○	◎	○	○
Upstream geomorphology	○	◎	○	○	○	○
Downstream geomorphology	◎	●	○	●	○	○
Water balance analysis	◎	○	◎	○	○	○
Key: ● Frequently needed ◎ Sometimes needed ○ Seldom needed						

Retrofits often involve a host of special construction considerations that should be reflected in the design package. Some common construction issues are described in Table 4.28, and in the retrofit profile sheets presented in Chapter 2.

Task 7.5 Contract and Construction Management

There are three basic approaches to moving a retrofit project into the construction phase:

- *In-House Construction Crews:* Use crews from public works, transportation, or parks departments to construct the retrofit.
- *Bid As A “Retrofit-Only” Project:* One or a group of retrofits can be packaged for bidding, so that the contractors are only bidding on the actual retrofit work.

- *Bundle Retrofits With Larger Project:* Retrofits can be put into a bigger construction package for road work, parking lot improvement, school or park renovations, drainage projects, etc.

The pros and cons of each approach are outlined in Table 4.29.

The main issue for a local program is to institutionalize retrofit construction, so that the effort can be sustained over a long time period. In that regard, all three approaches may be important for a successful local program. Also, the retrofit team should become familiar with local and state procurement procedures, and find the most efficient ways to move projects from the drafting board to the site.

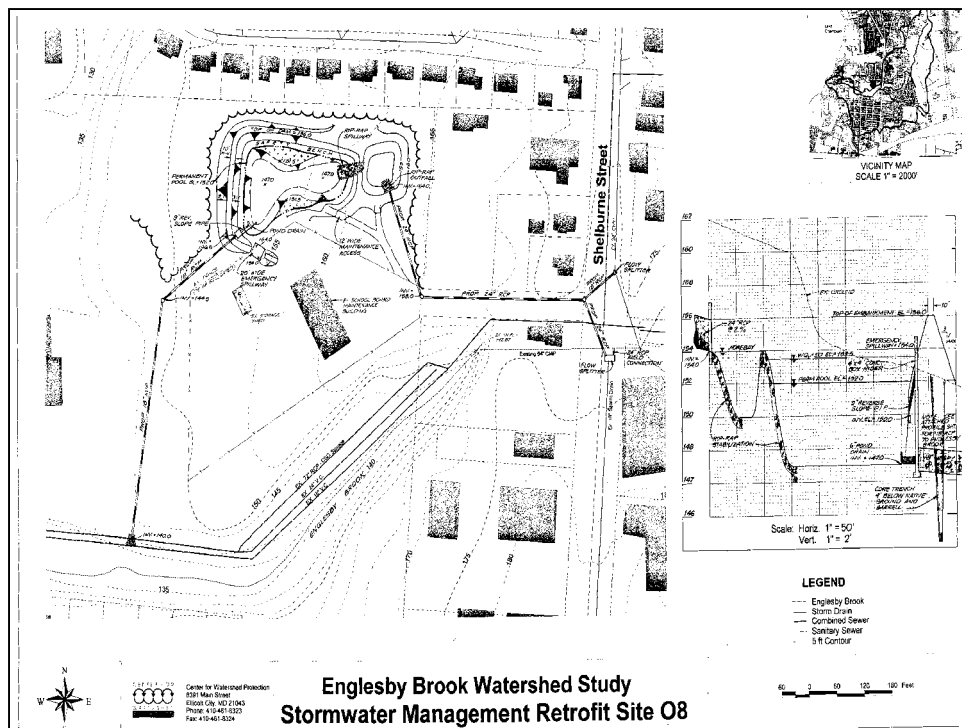

Figure 4.18: Construction drawings and specifications are part of the final retrofit design package

Table 4.28: Special Construction Considerations for Storage Retrofits

Construction Issue	SR-1 Pond	SR-2 Culvert	SR-3 Outfall	SR-4 Conveyance	SR-5 ROW	SR-6 Parking Lot
Temporary Stockpiling	●	⊙	⊙	●	●	●
Tight Construction Staging	●	●	⊙	●	●	⊙
Dewatering / Pumping	●	●	●	⊙	○	○
Temporary SW Diversion	●	●	⊙	⊙	○	○
In-Stream ESC work	○	●	⊙	⊙	○	○
Traffic Barriers/Management	○	●	○	○	●	●
Fencing to Exclude Public	●	⊙	⊙	⊙	⊙	●
Flow Splitter Inspection	○	○	●	⊙	⊙	⊙
Retrofit Equipment Washout	⊙	●	⊙	●	○	○
Off-Site Hauling	●	●	●	●	⊙	⊙
Utility Marking	●	⊙	⊙	⊙	●	●
Specialized Equipment	⊙	●	●	●	●	○

Key: ● Frequent problem; ⊙ Sometimes a problem; ○ Seldom a problem

Step 8: Inspection, Maintenance and Evaluation

Stormwater retrofitting is a continuous process, given that maintenance responsibility lasts throughout the entire life of the retrofit practice. Construction inspection, and retrofit evaluation tasks are all essential to ensure that it functions properly over its design life.

Task 8.1 Construction Inspection

Construction inspections are critical, since retrofits involve unique design elements on highly constrained sites. Contractors may also not be familiar with specialized construction techniques or innovative

retrofit practices. Therefore, designers should frequently inspect the retrofit throughout the construction process, answering contractor questions, approving design field modifications, holding regular

progress meetings, conducting construction testing, and reviewing construction records.

A final construction inspection is needed prior to completion of the as-built certification (Figure 4.19). If improvements are needed, inspectors compile a punchlist for the contractor of items to correct. As-built certification ensures the retrofit installation is constructed according to construction plans, and is a useful resource for future maintenance inspections.

Table 4.29: Pros and Cons of Different Ways to Secure Construction		
Approach	Pros	Cons
1. In-House Crews	<ul style="list-style-type: none"> • Cost-effective • Allows for on-the-job training of local staff • Spreads retrofit understanding and ethic across organization 	<ul style="list-style-type: none"> • Usually takes longer • Crews may not have access to needed equipment • Specialized skills may be lacking • Can be difficult to secure time and resources to get job done – routine tasks need to be deferred
2. Bid as Retrofit-Only	<ul style="list-style-type: none"> • Can attract specialized and skilled contractors interested in stormwater work • Can proceed at its own schedule • For smaller projects, procurement procedures can be simpler 	<ul style="list-style-type: none"> • Often difficult to get reasonable bids on small, specialized, or unfamiliar work • Inefficient in terms of mobilization and construction tasks • Often requires same level of project management as larger projects
3. Bundle Retrofit With Larger Project	<ul style="list-style-type: none"> • Can be efficient way to secure construction • Leverages skills and resources of capital projects staff • Best way to get reasonable bid 	<ul style="list-style-type: none"> • Must negotiate “add-on” to budgets that are usually tight • Selected contractor may be unfamiliar with retrofit work • Schedule is subject to vagaries of larger project • Retrofit component may not be priority for local CIP inspectors



Figure 4.19: A final inspection is needed to identify and correct any problems before as-built certification

Task 8.2 Retrofit Maintenance

Successfully retrofit programs plan and budget for future retrofit maintenance. The public and key restoration partners normally have high expectations that the appearance of retrofits installed on public land will be kept up. At the same time, retrofits normally require more frequent maintenance compared to new stormwater practices for several reasons. First, many retrofits tend to be slightly undersized and may require more frequent cleanout. Also, since space is at a premium, maintenance access and staging can be complicated. Lastly, retrofits often contain design features such as flow splitters, pretreatment cells and overflows that are prone to clogging. Therefore, communities will need to explicitly define how their retrofits will be maintained over time. Excellent guidance on developing an effective local maintenance program can be found in CWP (2007).

When retrofits become part of public stormwater infrastructure, communities need to take the several steps to ensure their future performance and longevity:

- Develop a specific maintenance plan for each retrofit that contains specific maintenance tasks, schedules and vendors, and clearly outlines any third party responsibilities.
- Perform annual retrofit maintenance inspections
- Create and maintain a retrofit tracking system to store essential information on the design, construction and maintenance history of individual retrofits.
- Allocate at least 15% of the retrofit capital budget for ongoing maintenance.
- Retain a maintenance call contractor so the community can quickly respond to

unexpected or chronic retrofit maintenance problems.

- Train municipal maintenance crews on unique maintenance and vegetation management practices associated with retrofits on golf courses, parks, highways and municipal lands.
- Consider an on-going education program to remind homeowners on how to maintain their retrofits that may have been subsidized by the community.

Task 8.3 Retrofit Project Evaluation

Every stormwater retrofit is an experiment – designers need to measure whether the retrofit projects they build are really working as designed. Two approaches can be used to monitor the performance of retrofit practices. The first approach is a simple visual assessment of the structural or vegetative integrity of a group of retrofits, whereas the second approach seeks to measure the pollution removal performance associated with an individual retrofit (see Manual 2).

The visual assessment approach involves inspecting groups of retrofits to assess their function, longevity, and survival over time. This may include inspections of hydraulic performance and physical integrity, survival of the aquatic plant community, or potential impacts to the upland plant community. The visual assessments provide key performance data to improve future retrofit design and construction.

Performance monitoring relies on intensive stormwater monitoring of individual retrofits to sample their pollutant removal capability. This may be measured directly through storm sampling of pollutant mass into and out of the retrofit, or indirectly through sampling of pollutant accumulation in bottom sediments.

References

- Atlanta Regional Commission (ARC). 2001. Georgia stormwater design manual. Volume 2: Technical handbook. Atlanta, GA.
- Arizona Department of Environmental Quality (ADEQ). 2000. Guidance for design, installation, operation and maintenance of dry wells. Phoenix, AZ
- Bannerman, R., D. Owens and N. Hornewer. 1993. Sources of pollutants in Wisconsin stormwater. *Water Science Technology*. 28(3-5): 241-259.
- Brown, W. and T. Schueler. 1997. The economics of stormwater BMPs in the Mid-Atlantic region Prepared for: Chesapeake Research Consortium. Edgewater, MD. Center for Watershed Protection. Ellicott City, MD.
- Brown, E., D. Caraco and R. Pitt. 2004. Illicit discharge detection and elimination: a guidance manual for program development and technical assessments. U.S. Environmental Protection Agency. Office of Wastewater Management. Center for Watershed Protection. Ellicott City, MD
- Burton, G. and R. Pitt. 2002. Stormwater effects handbook: a toolbox for watershed managers, scientists and engineers. CRC/Lewis Publishers, Boca Raton, FL
- Cappiella, K. and K. Brown. 2001. Impervious cover and land use in the Chesapeake Bay watershed. Chesapeake Research Consortium. Center for Watershed Protection. Ellicott City, MD
- Cappiella, K., T. Wright and T. Schueler. 2005. *Urban Watershed Forestry Manual*. Part 1. Methods for increasing forest cover in a watershed. USDA Forest Service. Newton Square, PA.
- Cappiella, K., T. Schueler, and T. Wright. 2006a. *Urban Watershed Forestry Manual*. Part 2: Conserving and planting trees at development sites. USDA Forest Service, Newtown Square, PA.
- Cappiella, K., A. Kitchell and T. Schueler. 2006b. Watershed approach for protecting wetlands. *Wetlands and Watershed Series Article 3*. U.S. EPA. Center for Watershed Protection. Ellicott City, MD.
- Cappiella, K., T. Schueler, J. Tomlinson and T. Wright. 2007. *Urban Watershed Forestry Manual*. Part 3: Urban tree planting guide. USDA Forest Service, Newtown Square, PA.
- Cappiella, K., and L. Fraley-McNeal. 2007. The importance of protecting vulnerable streams and wetlands at the local level. *Wetlands and Watersheds Article 6*. U.S. EPA. Center for Watershed Protection. Ellicott City, MD.

References

- Caraco, D. 1997. Stormwater BMP design supplement for cold climates. Prepared for US EPA Office of Wetlands, Oceans and Watersheds. Center for Watershed Protection, Ellicott City, MD
- Caraco, D. 2000. Stormwater strategies for arid and semi-arid watersheds. *Watershed Protection Techniques*. 3(3):695-706.
- Caraco, D. 2001. The watershed treatment model: Version 3.0. U.S. Environmental Protection Agency, Region V. Center for Watershed Protection. Ellicott City, MD
- Center for Watershed Protection (CWP). 2003. Impacts of impervious cover on aquatic ecosystems. *Watershed Protection Techniques Monograph No. 1*. Ellicott City, MD
- CWP. 2004a. Redevelopment roundtable consensus document. Ellicott City, MD
- CWP. 2004b. DRAFT Stormwater and wetland maintenance guidebook. Ellicott City, MD.
- CWP. 2005. Pollution source control practices. Manual 8 of the Urban Subwatershed Restoration Manual Series. Ellicott City, MD.
- CWP. 2006. Smart watershed benchmarking guide. Ellicott City, MD.
- CWP. 2007. Post construction program building manual. Ellicott City, MD.
- Chicago Department of Environmental Protection (Chicago DEP) 2003. A guide to stormwater best management practices. Chicago, IL.
- Claytor, R. and T. Schueler. 1996. Design of stormwater filtering systems. Prepared for Chesapeake Research Consortium. Center for Watershed Protection. Ellicott City, MD.
- Claytor, R. 2003. Personal communication. Horsley Witten Group, Inc. Sandwich, MA.
- Davis, A. 2005. Green engineering principles promote low impact development. *Environment, Science and Technology*. 39(16): 338-344.
- Dewberry and Davis, Inc. 1990. Investigation of potential sediment toxicity from BMP ponds. Prepared for the Northern Virginia Planning District Commission, the Occoquan Policy Board, and the Virginia State Water Control Board.
- Driver, N., M. Mustard, R. Rhinesmith and R. Middleburg. 1985. Urban stormwater database for 22 metropolitan areas throughout the United States. U.S. Geological Survey Open File Report 85-337. Denver, CO.
- Echols, M. and L. Pennypacker. 2006. Art for rain's sake. *Landscape Architecture*. September 2000.

- Eccher, C. 1991. Thoughtful design is prime factor in water safety. *Lake Line*. pp. 4-8.
- Emmerling-DiNovo, C. 1995. Stormwater detention basins and residential locational decisions. *Water Resources Bulletin*. 31(3):515-521.
- France, R. 2003. *Handbook of Water Sensitive Planning and Design*. Lewis Publishers.
- Galli, J. 1990a. Peat sand filters: a proposed stormwater management practice for urbanized areas. Dept. of Environmental Programs. Metropolitan Washington Council of Governments. Washington, DC
- Galli, J. 1990b. Thermal impacts associated with urbanization and stormwater best management practices. Metropolitan Washington Council of Governments. Washington, D.C.
- Galli, J. 1992. Analysis of urban BMP performance and longevity in Prince George's County, Maryland. Metropolitan Washington Council of Governments. Washington, DC.
- Harrington, B. 1987. Design procedures for stormwater management extended detention structures. Report to Water Resources Administration. Maryland Department of Natural Resources. Annapolis, MD.
- Hathaway, J. and W. Hunt. 2006. Stormwater BMP costs. North Carolina State University. Department of Biological and Agricultural Engineering. Raleigh, NC.
- Hey, D. and G. Schaefer. 1983. An evaluation of the water quality effects of detention storage and source control. U.S. Environmental Protection Agency and the Northeastern Illinois Planning Commission, Chicago.
- Horner, R. H. Lim and S. Burges. 2003. Hydrologic monitoring of the Seattle ultra-urban stormwater management project. University of Washington. Department of Civil and Environmental Engineering. Water Resources Series. Technical Report 170.
- Hoyt, S. and J. Zielinski. 2006. Concept designs and stormwater strategy for catchment O in watershed 263. Parks and People Foundation and Baltimore City Department of Public Works. Baltimore, MD.
- Hoyt, S. 2007. Stormwater retrofit cost database. Unpublished document. Center for Watershed Protection. Ellicott City, MD.
- Hunt, W. A. Jarret, J. Smith and L. Sharkey. 2006. Evaluating bioretention hydrology and nutrient removal at three field sites in North Carolina. *Journal of Irrigation and Drainage Engineering*. 6: 600-612.
- Hunt, W. and W. Lord. 2006a. Bioretention performance, design, construction and maintenance. North Carolina Cooperative Extension Service. *Urban Waterways*. AG-588-05.

References

- Hunt, W. and W. Lord. 2006b. Maintenance of stormwater wetlands and wet ponds. *Urban Waterways*. NC State University and North Carolina Cooperative Extension
- Hunt, W., C. Apperson, and W. Lord. 2005. Mosquito control for stormwater facilities. *Urban Waterways*. NC State University North Carolina Cooperative Extension.
- Jones, J., S. Anderson, J. Fognani, F. McGregor, and T. Axley. 1996. Stormwater best management practices: When is sediment considered hazardous? *Water Environment & Technology*. 8(10):51-57.
- Jones, J. and D. Jones. 1982. Interfacing considerations in urban detention ponding. *Proceedings of the Conference on Stormwater Detention Facilities, Planning, Design, Operation, and Maintenance*, Henniker, New Hampshire, Edited by W. DeGroot, published by the American Society of Civil Engineers, New York.
- Ladd, B.T. and J.R. Frankenberger. 2003. Management of Ponds, Wetlands, and Other Water Reservoirs to Minimize Mosquitoes, WQ-41-W. 8 pgs, Purdue Extension.
- Land and Water. 1996. Storm pond turned into selling feature. *Land and Water*. 40(6):35.
- Lake George Park Commission (LGPC). 2003. Stormwater management guide for minor projects. Lake George, NY.
- Law, N. 2006. Research in support of an interim pollutant removal rate for street sweeping and storm drain cleanout. Technical Memo No. 2. Prepared for the EPA Chesapeake Bay Program and Urban Stormwater Working Group. Center for Watershed Protection. Ellicott City, MD.
- Liptan, T. and E. Strecker. 2003. Ecoroofs – a more sustainable infrastructure. Presented at Urban Stormwater: Enhancing Programs at the Local Level. February 17-20, 2003. Chicago, IL.
- Low Impact Development Center (LID Center). 2003. Municipal guide to low impact development. Beltsville, MD.
- Maestre, A. and R. Pitt. 2005. Identification of significant factors affecting stormwater quality using the NSQD. University of Alabama. Tuscaloosa, AL.
- Marcy, S. and J. Flack. 1981. Safety considerations in urban storm drainage design. *Second International Conference on Urban Storm Drainage*, Urbana, Illinois.
- Marsalek, J., D. Weatherbe, and G. Zukovs. 1982. Institutional aspects of stormwater detention. *Proceedings of the Conference on Stormwater Detention Facilities, Planning, Design, Operation, and Maintenance*, Henniker, New Hampshire, Edited by W. DeGroot, published by the American Society of Civil Engineers, New York.

- Maryland Department of Environment. 2000. Maryland stormwater design manual. Volumes I and II. Maryland Department of Environment. Baltimore, MD.
- Meyers, J. 2003. Where Rivers are born: the scientific imperative for defending small streams and wetlands. *American Rivers*. Washington, D.C.
- Meyer, J., D. Strayer, J. Wallace, S. Eggert, G. Helfman and N. Leonard. 2007. The contribution of headwater streams to biodiversity in river networks. *Journal of American Water Resources Association* 43(1): 86-103
- Minnesota Stormwater Steering Committee (MSSC). 2005. Minnesota Stormwater Manual. Emmons & Oliver Resources, Inc. Minnesota Pollution Control Agency. St. Paul MN.
- Natural Resources Conservation Service. 1986. Urban Hydrology for Small Watersheds. *Technical Release 55*. US Department of Agriculture. Washington, DC.
- New York State Department of the Environment (NYDEC). 2003. New York State stormwater management design manual. Albany, N.Y.
- Northern Virginia Planning District Commission (NVPDC). 2000. Maintaining your BMP; a guidebook for private owners and operators in Northern Virginia. Northern Virginia Planning District Commission. Division of Environmental Services.
- Ontario Ministry of Environment (OME). 2003. Stormwater management planning and design manual. Toronto, Canada.
- Peck, S. and M. Kuhn. 2005. Design guidelines for green roofs. Ontario Association of Architects and CMHC SCHL. Available online at http://www.page-house.com/clippings/design_guidelines_for_green_roofs.pdf
- Pitt, R. 1997. Multi-chamber treatment train developed for stormwater hotspots. *Watershed Protection Techniques*. 2(3):445-449
- Pitt, R. J. Lantrip and R. Harrison. 1999. Infiltration through disturbed urban soils and compost-amended soil effects on runoff quality and quantity. *Research Report EPA/600/R-00/016*. Office of Research and Development. U.S. EPA. Washington, D.C.
- Pitt, R., T. Brown and R. Morchque. 2004. *National Stormwater Quality Database. Version 2.0*. University of Alabama and Center for Watershed Protection. Final Report to U.S. Environmental Protection Agency.
- Pitt, R. S. Chen, S. Clark and J. Lantrip. 2005. Soil structure effects associated with urbanization and the benefits of soil amendments. World Water and Environmental Resources Congress. Conference Proceedings. American Society of Civil Engineers. Anchorage, AK.

References

- Portland BES. 2006a. Ecoroofs. City of Portland. Bureau of Environmental Services. Portland, OR.
- Portland BES. 2006b. Rain barrels. City of Portland. Bureau of Environmental Services. Portland, OR.
- Rodewald, A. 2001. Nuisance Canada geese: how to deal with the problem. Ohio State University Extension Publication No. W-3-2001.
- Roofscapes, Inc. 2003. Green technology for the urban environment.
- RS Means. 2006. *Site Work and Landscape Cost Data*. 25th Edition. RS Means. Kingston, MA.
- Santana, F., J. Wood, R. Parsons, and S. Chamberlain. 1994. Control of mosquito breeding in permitted stormwater systems. Southwest Florida Water Management District. Brooksville, FL.
- Schollen M., T. Schmidt and D. Maunder. 2006. Markham small streams study- policy update and implementing guidelines for the protection and management of small drainage courses. Town of Markham, Ontario.
- Schueler, T. 1987. Controlling urban runoff: a practical manual for planning and designing urban best management practices. Metropolitan Washington Council of Governments. Washington, DC.
- Schueler, T. 1992. Design of stormwater wetlands: guidelines for creating diverse and effective stormwater wetland systems in the Mid-Atlantic Region. Metropolitan Washington Council of Governments. Washington, D.C.
- Schueler, T. and D. Shepp. 1993. The quality of trapped sediments and pool water within oil grit separators in suburban Maryland. Interim Report. Metropolitan Washington Council of Governments.
- Schueler, T. 1994a. Pollutant dynamics of pond muck. *Watershed Protection Techniques*. 1(2): 39-46.
- Schueler, T. 1994b. *Site Planning for Urban Stream Protection*. Center for Watershed Protection and Metropolitan Washington Council of Governments. Washington, D.C.
- Schueler, T. 1995a. The pond premium. *Watershed Protection Techniques*. 2(1): 302-303.
- Schueler, T. 1995b. Mosquitoes in constructed wetlands: A management bugaboo?. *Watershed Protection Techniques*. 1(4): 203-207.

- Schueler, T. 1999. Microbes and urban watersheds: ways to kill 'em. *Watershed Protection Techniques*. 3(1): 566-574.
- Schueler, T. 2000a. Further developments in sand filter technology to treat stormwater runoff. *Watershed Protection Techniques*. 3(3): 707-716.
- Schueler, T. 2000b. Can urban soil compaction be reversed? *Watershed Protection Techniques*. 3(2): 666-669.
- Schueler, T. 2000c. The environmental impacts of stormwater ponds. Article 79. *The Practice of Watershed Protection*. Center for Watershed Protection. Ellicott City, MD.
- Schueler, T. 2004. An integrated framework to restore small urban watersheds. Manual 1. *Small Watershed Restoration Manual Series*. Center for Watershed Protection. Ellicott City, MD.
- Schueler, T. 2005. Methods to develop restoration plans for small urban watersheds. Manual 2. *Small Watershed Restoration Manual Series*. U.S. EPA. Center for Watershed Protection. Ellicott City, MD.
- Seattle Metro and Washington Department of Ecology. 1992. Biofiltration swale performance: recommendations, and design considerations. Publication No. 57. Olympia, WA.
- Shaw, D. and R. Schmidt. 2003. Plants for stormwater design: species selection for the upper Midwest. Minnesota Pollution Control Agency. St. Paul, MN.
- Smith, R and W. Hunt. 2007. Pollutant removals in bioretention cells with grass cover. Proceedings 2nd National Low Impact Development Conference. Wilmington, NC. March 13-15, 2007.
- Smullen, J. and K. Cave. 2002. National stormwater runoff pollution database. In: *Wet-Weather Flow in the Urban Watershed*. Edited by R. Field and D. Sullivan. Lewis Publishers. Boca Raton, FL. pp. 67-78.
- Steuer, J., W. Selbig, N. Hornewer and J. Prey. 1997. Sources of contamination in an urban basin in Marquette, MI and an analysis of concentrations, loads and data quality. U.S. Geological Survey Water Resources Investigation Report 97-4242.
- Stephens, K., P. Graham, D. Reid. 2002. Stormwater planning: a guidebook for British Columbia. Environment Canada. Vancouver, British Columbia.
- Strecker, E., M. Quigley, B. Urbonas and J. Jones. 2004. Stormwater management- state of the art in comprehensive approaches to stormwater. *The Water Report*. 6:1-10.

References

- Sturm, P. 2003. Adopt-a-pond program document. Herring Run Watershed Association and Baltimore County Department of Environmental Protection and Resource Management. Center for Watershed Protection. Ellicott City, MD
- Traver, R. 2006. Monitoring summary: Villanova University stormwater best management practice study. U.S EPA. Philadelphia, PA.
- University of New Hampshire Stormwater Center (UNHSC). 2005. 2005 stormwater data report. Durham, NH.
- University of Wisconsin Extension Office (UWEO). 2003. Raingardens: a household way to improve water quality in your community. Madison, WI.
- Urban Stormwater Work Group (USWG) 2003. The urban environment and mosquito management. Chesapeake Bay Program (CBP). Annapolis, MD
- U.S. Environmental Protection Agency (US EPA). 1983. Results of the nationwide urban runoff program. Water Planning Division. PB 84-185552. Washington, DC.
- U.S. Census. 2006. Trends in municipal capital budget expenditures: 1979 to 2005. Department of Commerce. Washington DC
- Walton, W. E. 2003. Managing mosquitoes in surface-flow constructed treatment wetlands. University of California Division of Agriculture and Natural Resources, Publication 8117.
- Water Environment Research Foundation (WERF). 2004. Post-project monitoring on BMPs/SUDS to determine performance and whole-life costs. IWA Publishing. Alexandria, VA.
- Waschbusch, R., W. Selbig and R. Bannerman. 2000. Sources of phosphorus in stormwater and street dirt from two residential basins in Madison, Wisconsin. In: National Conference on Tools for Urban Water Resource Management and Protection. US EPA. Chicago, IL
- Wetland Studies and Solutions, Inc. (WSSI). 2006. Low impact development. Wetland Studies and Solutions, Inc. Gainesville, VA.
- Wisconsin Department of Natural Resources (WDNR). 2003. Rain gardens: A how-to manual for homeowners. Madison, WI.
- Wossink, A. and W. Hunt. 2003. The economics of structural stormwater BMPs in North Carolina. North Carolina State University. Department of Biological and Agricultural Engineering. Raleigh, NC.
- Winer, R. 2000. National pollutant removal performance database - 2nd Edition. Center for Watershed Protection. Ellicott City, MD.

Winer, R. 2003. Critical area 10% rule guidance manual: Maryland Chesapeake and Atlantic Coastal Bays. Critical Area Commission, Annapolis, MD

Wright, T., J. Tomlinson, T. Schueler and K. Capiella. 2007. Direct and indirect impacts of urbanization on wetland quality. *Wetlands and Watersheds Article 1*: U.S. EPA OWOW and Center for Watershed Protection. Ellicott City, MD

Yousef, Y. and L. Lin. 1990. Toxicity of bottom sediments in detention ponds. *Environmental Engineering: Proceedings of the 1990 Specialty Conference*. pp. 809 - 816. American Society of Civil Engineering, New York

References