



May 17, 2016

Ms. Bev McKeone
NSR Program Manager
Division of Air Quality – Permitting Section
West Virginia Department of Environmental Protection
601 57th Street, SE
Charleston, West Virginia 25304

**Re: Permit Determination Form
Fairmont Brine Processing
Permit R13-2794**

Dear Ms. McKeone,

Enclosed for your review is West Virginia Department of Environmental Protection (WVDEP) Permit Determination Form for Fairmont Brine Processing, LLC's (FBP's) water treatment facility located at 168 AFR Drive, Fairmont, West Virginia 26554. This form is submitted in regard to Permit R13-2794. This request for determination includes the following modifications:

- Modify Source E-3: FBP plans to replace an existing heat exchanger, which will allow for an increase in plant capacity. This change will increase Emissions E-3.
- Add Source S-6: FBP plans to expand their pretreatment operations to include chemical precipitation, clarification, and effluent and sludge processing. This includes the installation of a lime silo (new Emissions E-6).
- Add Source S-7: FBP plans to install a second natural gas fueled boiler (new Emissions E-7) to provide a redundant heat source for the evaporation process.

If you have any questions, or require additional information, please contact me at (412) 680-6244 or via email at bkalt@fairmontbrine.com.

Sincerely,
Fairmont Brine Processing, LLC

A handwritten signature in blue ink that reads "B. Kalt".

Brian Kalt
President



WEST VIRGINIA
DEPARTMENT OF ENVIRONMENTAL PROTECTION
DIVISION OF AIR QUALITY
601 57th Street, SE
Charleston, WV 25304
Phone: (304) 926-0475
www.dep.wv.gov/daq

**PERMIT DETERMINATION FORM
(PDF)**

FOR AGENCY USE ONLY: PLANT I.D. # _____
PDF # _____ PERMIT WRITER: _____

1. NAME OF APPLICANT (AS REGISTERED WITH THE WV SECRETARY OF STATE'S OFFICE):

Fairmont Brine Processing

2. NAME OF FACILITY (IF DIFFERENT FROM ABOVE):

3. NORTH AMERICAN INDUSTRY CLASSIFICATION SYSTEM (NAICS) CODE:

2 1 3 1 1 2

4A. MAILING ADDRESS:

1501 Reedsdale Street, Suite 505
Pittsburgh, PA 15233

4B. PHYSICAL ADDRESS:

168 AFR Drive, Fairmont, WV 26554

5A. DIRECTIONS TO FACILITY (PLEASE PROVIDE MAP AS ATTACHMENT A):

From I-79, take exit 137. Merge onto WV-310 N toward Downtown/Fairmont. Stay straight to go onto Speedway Avenue/Old WV-73. Continue to follow Speedway Avenue. Turn left onto CR-7/22/Suncrest Boulevard. Turn slight left onto Montana Road/CR-7/24. Turn slight right onto CR-7/24. Turn slight right onto Hoult Road/Suncrest Boulevard. Turn left to stay on Hoult Road/Suncrest Boulevard. Turn slight left onto AFR Drive.

5B. NEAREST ROAD:

AFR Drive

5C. NEAREST CITY OR TOWN:

Fairmont

5D. COUNTY:

Marion

5E. UTM NORTHING (KM):

4,373.5

5F. UTM EASTING (KM):

575.2

5G. UTM ZONE:

17

6A. INDIVIDUAL TO CONTACT IF MORE INFORMATION IS REQUIRED:

Brian Kalt

6B. TITLE:

President

6C. TELEPHONE:

(412) 680-6244

6D. FAX:

6E. E-MAIL:

BKalt@fairmontbrine.com

7A. DAQ PLANT I.D. NO. (FOR AN EXISTING FACILITY ONLY):

0 4 9 - 0 0 1 3 0

7B. PLEASE LIST ALL CURRENT 45CSR13, 45CSR14, 45CSR19 AND/OR TITLE V (45CSR30) PERMIT NUMBERS ASSOCIATED WITH THIS PROCESS (FOR AN EXISTING FACILITY ONLY):

R13-2794

7C. IS THIS PDF BEING SUBMITTED AS THE RESULT OF AN ENFORCEMENT ACTION? IF YES, PLEASE LIST:

No

8A. TYPE OF EMISSION SOURCE (CHECK ONE):

- NEW SOURCE ADMINISTRATIVE UPDATE
 MODIFICATION OTHER (PLEASE EXPLAIN IN 11B)

8B. IF ADMINISTRATIVE UPDATE, DOES DAQ HAVE THE APPLICANT'S CONSENT TO UPDATE THE EXISTING PERMIT WITH THE INFORMATION CONTAINED HEREIN?

- YES NO

9. IS DEMOLITION OR PHYSICAL RENOVATION AT AN EXISTING FACILITY INVOLVED?

- YES NO

10A. DATE OF ANTICIPATED INSTALLATION OR CHANGE:

06 / 28 /2016 .

10B. DATE OF ANTICIPATED START-UP:

09 / 16 /2016 .

11A. PLEASE PROVIDE A DETAILED PROCESS FLOW DIAGRAM SHOWING EACH PROPOSED OR MODIFIED PROCESS EMISSION POINT AS ATTACHMENT B.

11B. PLEASE PROVIDE A DETAILED PROCESS DESCRIPTION AS ATTACHMENT C.

12. PLEASE PROVIDE MATERIAL SAFETY DATA SHEETS (MSDS) FOR ALL MATERIALS PROCESSED, USED OR PRODUCED AS ATTACHMENT D. FOR CHEMICAL PROCESSES, PLEASE PROVIDE A MSDS FOR EACH COMPOUND EMITTED TO AIR.

13A. REGULATED AIR POLLUTANT EMISSIONS:

⇒ **FOR A NEW FACILITY**, PLEASE PROVIDE PLANT WIDE EMISSIONS BASED ON THE POTENTIAL TO EMIT (PTE) FOR THE FOLLOWING AIR POLLUTANTS INCLUDING ALL PROCESSES.

⇒ **FOR AN EXISTING FACILITY**, PLEASE PROVIDE THE PROPOSED CHANGE IN EMISSIONS BASED ON THE PTE OF ALL PROCESS CHANGES FOR THE FOLLOWING AIR POLLUTANTS.

PTE FOR A GIVEN POLLUTANT IS TYPICALLY BEFORE AIR POLLUTION CONTROL DEVICES AND IS COLLECTED BASED ON THE MAXIMUM DESIGN CAPACITY OF PROCESS EQUIPMENT.

POLLUTANT	HOURLY PTE (LB/HR)	YEARLY PTE (TON/YR)
	Proposed Emissions (Change from Current Permit Limits)	(HOURLY PTE MULTIPLIED BY 8760 HR/YR) DIVIDED BY 2000 LB/TON Proposed Emissions (Change from Current Permit Limits)
PM	0.47 (+0.14)	1.76 (+0.32)
PM ₁₀	0.47 (+0.14)	1.76 (+0.32)
VOCs	0.48 (+0.03)	2.09 (+0.15)
CO	2.98 (-0.56)	13.03 (-2.47)
NO _x	3.81 (-0.29)	16.70 (-1.27)
SO ₂	0.04 (+0.02)	0.18 (+0.08)
Pb	0.004 (not included)	0.02 (not included)
HAPs (AGGREGATE AMOUNT)	0.05 (-0.10*)	0.23 (-0.43*)
TAPs (INDIVIDUALLY)*	0.03 (not included)	0.12 (not included)
OTHER (INDIVIDUALLY)*	NA	NA

* ATTACH ADDITIONAL PAGES AS NEEDED *Based on emission of VOCs and total HAPs from Evaporator (E-3) not to exceed 0.15 lb/hour.

13B. PLEASE PROVIDE ALL SUPPORTING CALCULATIONS AS ATTACHMENT E.

CALCULATE AN HOURLY AND YEARLY PTE OF EACH PROCESS EMISSION POINT (SHOWN IN YOUR DETAILED PROCESS FLOW DIAGRAM) FOR ALL AIR POLLUTANTS LISTED ABOVE INCLUDING INDIVIDUAL HAP'S (LISTED IN SECTION 112[b] OF THE 1990 CAAA), TAP'S (LISTED IN 45CSR27), AND OTHER AIR POLLUTANTS (E.G. POLLUTANTS LISTED IN TABLE 45-13A OF 45CSR13, MINERAL ACIDS PER 45CSR7, ETC.).

14. CERTIFICATION OF DATA

I, Brian Kalt (TYPE NAME) ATTEST THAT ALL THE REPRESENTATIONS CONTAINED IN THIS APPLICATION, OR APPENDED HERETO, ARE TRUE, ACCURATE, AND COMPLETE TO THE BEST OF MY KNOWLEDGE BASED ON INFORMATION AND BELIEF AFTER REASONABLE INQUIRY, AND THAT I AM A **RESPONSIBLE OFFICIAL**** (PRESIDENT, VICE PRESIDENT, SECRETARY OR TREASURER, GENERAL PARTNER OR SOLE PROPRIETOR) OF THE APPLICANT.

SIGNATURE OF RESPONSIBLE OFFICIAL: B. Kalt

TITLE: President, Fairmont Brine Processing DATE: 5 / 17 / 2016

**THE DEFINITION OF THE PHRASE 'RESPONSIBLE OFFICIAL' CAN BE FOUND AT 45CSR13, SECTION 2.23.

NOTE: PLEASE CHECK ENCLOSED ATTACHMENTS:
 ATTACHMENT A ATTACHMENT B ATTACHMENT C ATTACHMENT D ATTACHMENT E

RECORDS ON ALL CHANGES ARE REQUIRED TO BE KEPT AND MAINTAINED ON-SITE FOR TWO (2) YEARS.
 THE PERMIT DETERMINATION FORM WITH THE INSTRUCTIONS CAN BE FOUND ON DAQ'S PERMITTING SECTION WEB SITE:
www.dep.wv.gov/daq



ATTACHMENT A

SITE LOCATION MAP



ATTACHMENT A – SITE LOCATION MAP

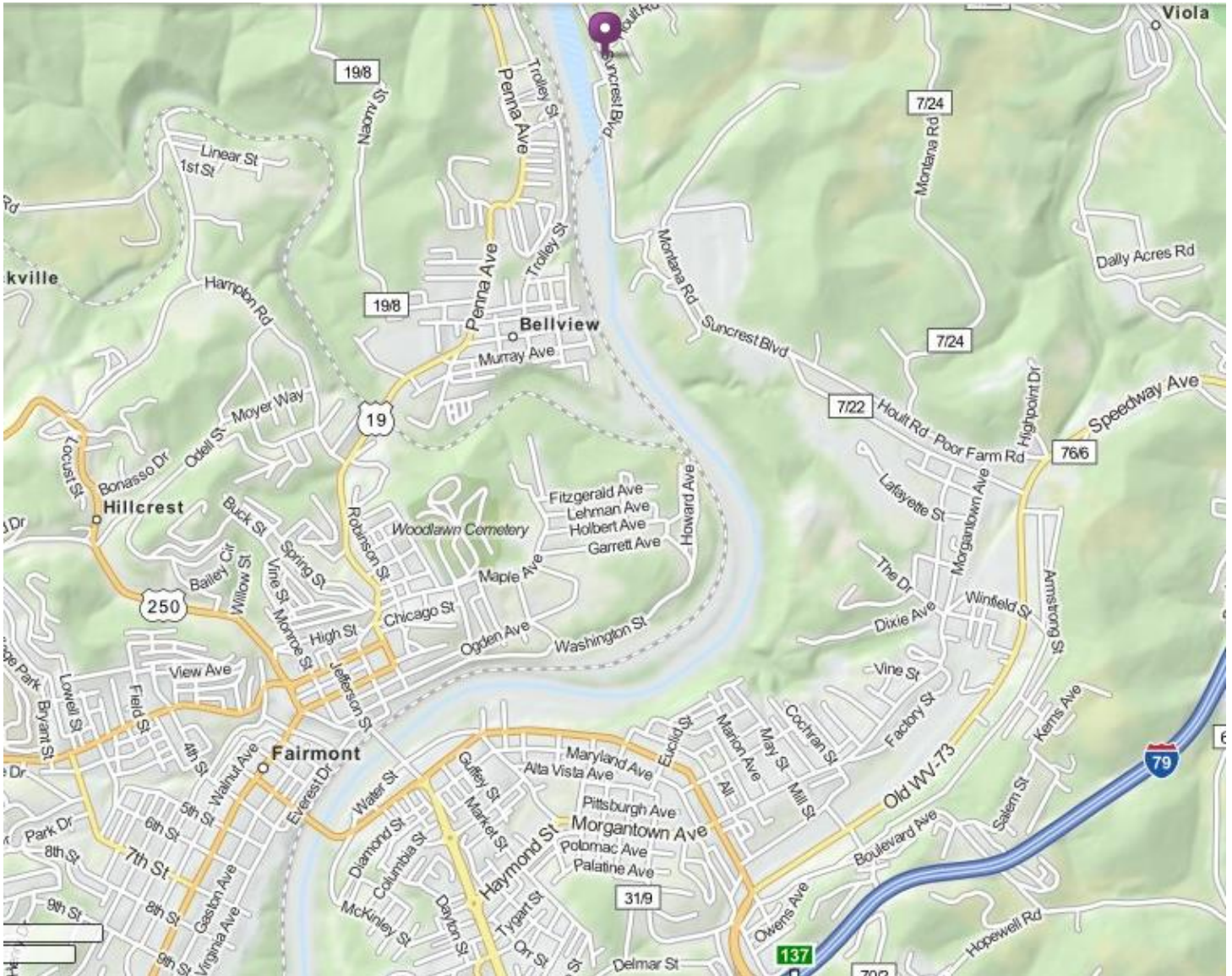



ATTACHMENT B

DETAILED PROCESS FLOW DIAGRAMS

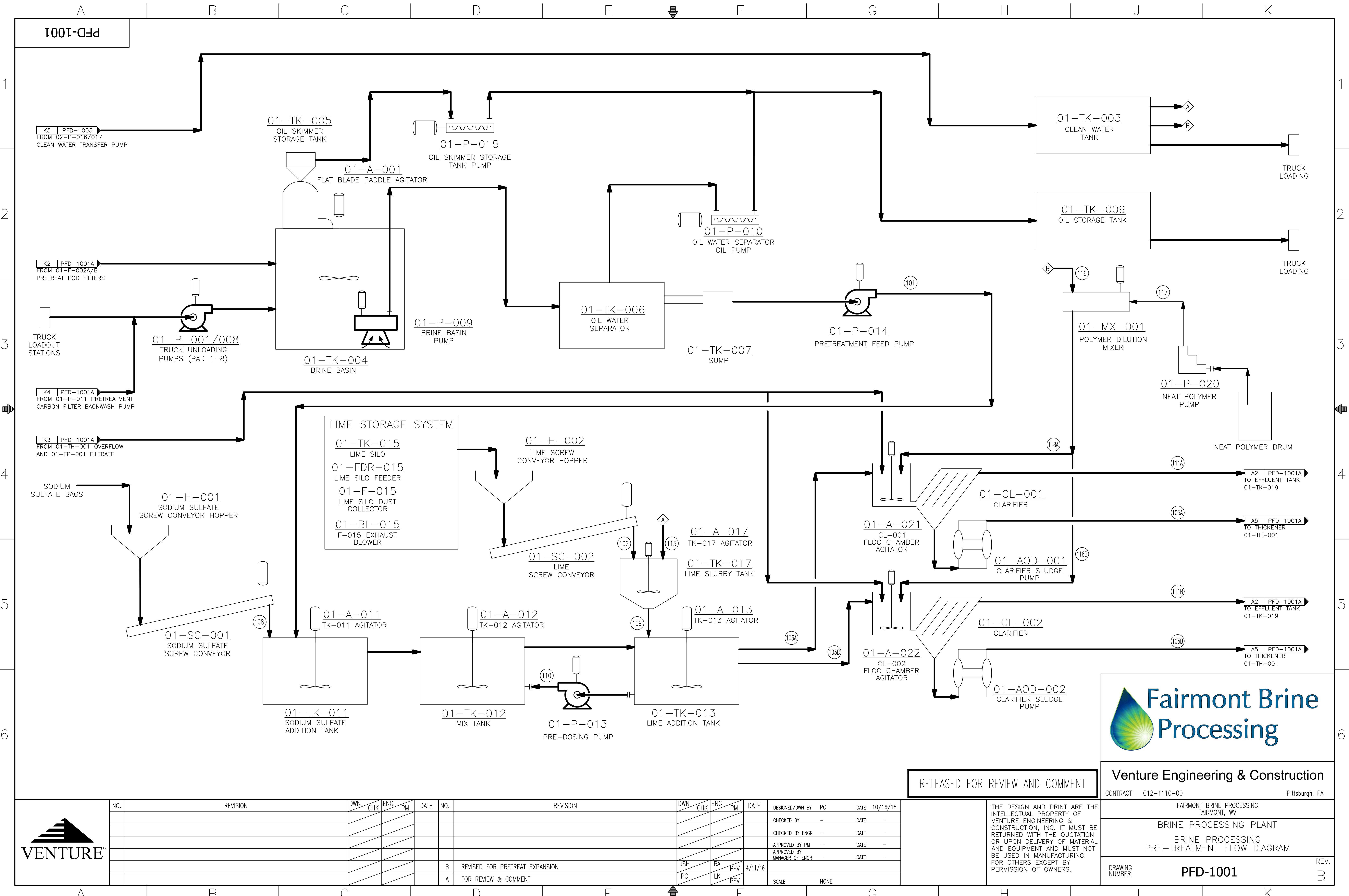

Venture Engineering & Construction
 CONTRACT C12-1110-00 Pittsburgh, PA

FAIRMONT BRINE PROCESSING
 FAIRMONT, WV
 BRINE PROCESSING PLANT
 BRINE PROCESSING
 PRE-TREATMENT FLOW DIAGRAM

DRAWING NUMBER **PFD-1001** REV. B

RELEASED FOR REVIEW AND COMMENT

THE DESIGN AND PRINT ARE THE INTELLECTUAL PROPERTY OF VENTURE ENGINEERING & CONSTRUCTION, INC. IT MUST BE RETURNED WITH THE QUOTATION OR UPON DELIVERY OF MATERIAL AND EQUIPMENT AND MUST NOT BE USED IN MANUFACTURING FOR OTHERS EXCEPT BY PERMISSION OF OWNERS.



NO.	REVISION	DWN	CHK	ENG	PM	DATE	NO.	REVISION	DWN	CHK	ENG	PM	DATE	DESIGNED/DWN BY	PC	DATE	10/16/15
														CHECKED BY	-	DATE	-
														CHECKED BY ENGR	-	DATE	-
														APPROVED BY PM	-	DATE	-
														APPROVED BY MANAGER OF ENGR.	-	DATE	-
	B								JSH	RA	PEV		4/11/16				
	A								PC	LK	PEV						
														SCALE	NONE		

A B C D E F G H J K

PFD-1001A

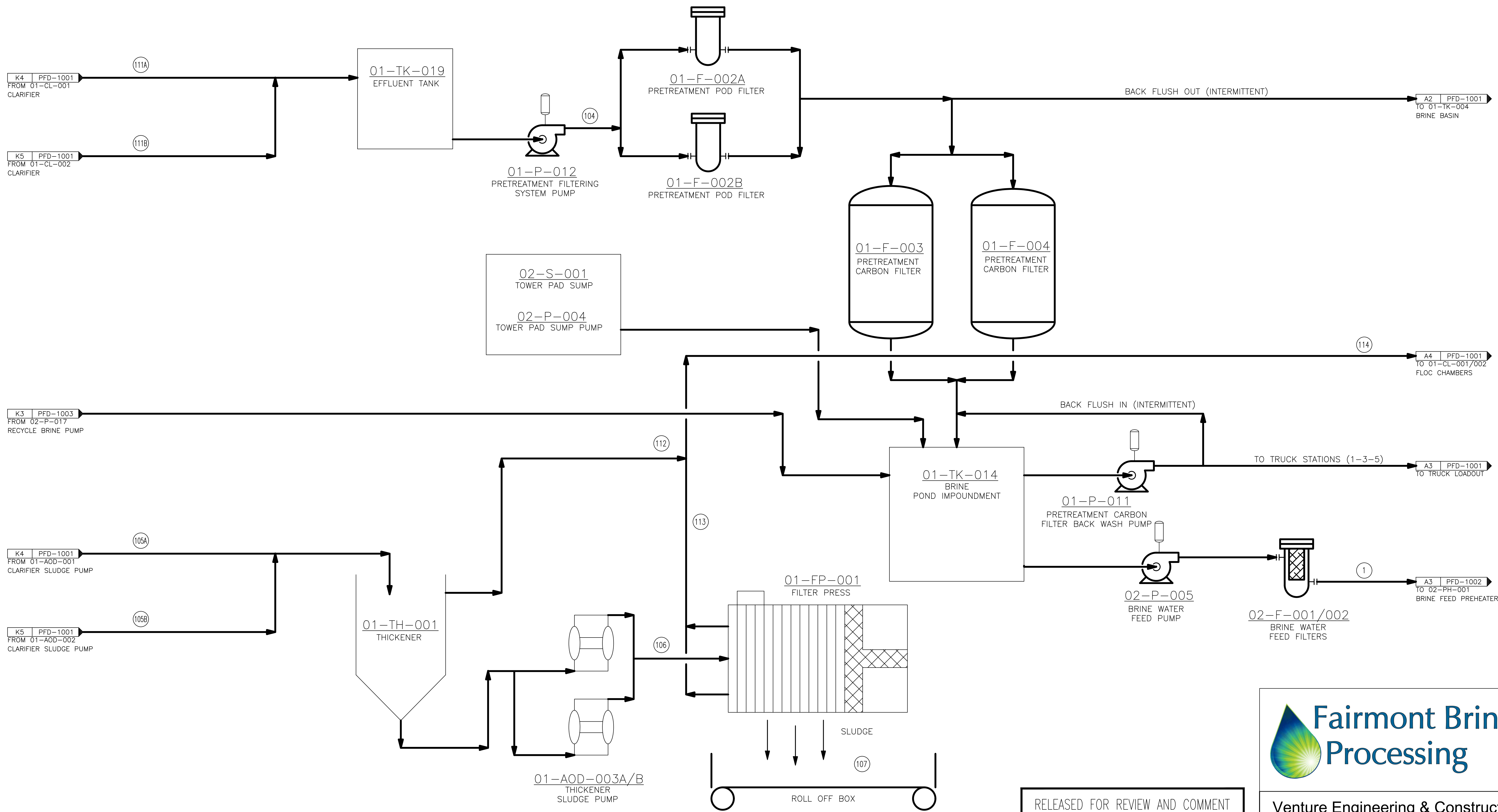

RELEASED FOR REVIEW AND COMMENT



Venture Engineering & Construction
 CONTRACT C12-1110-00 Pittsburgh, PA

FAIRMONT BRINE PROCESSING
 FAIRMONT, WV
 BRINE PROCESSING PLANT
 BRINE PROCESSING
 FLOW DIAGRAM

DRAWING NUMBER PFD-1001A REV. B



NO.	REVISION	DWN	CHK	ENG	PM	DATE	NO.	REVISION	DWN	CHK	ENG	PM	DATE	DESIGNED/DWN BY	PC	DATE	10/16/15
B	REVISED FOR PRETREATMENT EXPANSION								JSH	RA	PEV		4/11/16				
A	FOR REVIEW & COMMENT								PC	LK	PEV						

THE DESIGN AND PRINT ARE THE INTELLECTUAL PROPERTY OF VENTURE ENGINEERING & CONSTRUCTION, INC. IT MUST BE RETURNED WITH THE QUOTATION OR UPON DELIVERY OF MATERIAL AND EQUIPMENT AND MUST NOT BE USED IN MANUFACTURING FOR OTHERS EXCEPT BY PERMISSION OF OWNERS.

SCALE NONE

BWT001-CFD

Fairmont Brine Processing PFD-1001/1A Mass Balance	
Project No.:	C15-1205-04
Project Name:	FBP - D&I - Pretreatment Expansion
Rev.:	B
Rev. Date:	4/11/2016

Stream No.	1	101	102	103A/B	104	105A/B (BATCH)	106 (BATCH)	107 (BATCH)	108	109	110	111A/B	112	113	114	115	116	117	118A/B	
ChemCAD Ref.	54	-	-	-	-	-	-	-	-	-	-	-	-	-	-	-	-	-	-	-
Stream Name	Feed to 02-PH-001	Pretreatment Feed	Dry Hydrated Lime	Feed to Clarifier	Treated Brine	Clarifier Sludge	Thickner Sludge	Pressed Sludge	Dry Sodium Sulfate	Lime Slurry	Reactor Tank Pre-Dosing	Clarifier Effluent	Thickener Overflow	Filter Press Filtrate	Overflow & Filtrate Return	CW to Lime Slurry	CW to Polymer Dilution	Neat Polymer	Diluted Polymer to CL	
Temp F	50.82	50	50	50	50	50	50	50	50	55	55	55	55	55	55	55	55	55	55	55
Pres psia	185.00	45	15	15	56	35	45	15	15	15	27	15	15	30	15	60	60	-	60	
Enth MMBtu/hr	-552.69	-	-	-	-	-	-	-	-	-	-	-	-	-	-	-	-	-	-	-
Vapor mole frac.	0.00	-	-	-	-	-	-	-	-	-	-	-	-	-	-	-	-	-	-	-
pH value	7.03	4.5-6.5	N/A	11	11	11	11	11	4.5-6.5	12	11	11	11	11	11	7	7	7	-	-
Ionic str. Molal	4.37	-	-	-	-	-	-	-	-	-	-	-	-	-	-	-	-	-	-	-
Total lbmol/hr	4582.69	-	-	-	-	-	-	-	-	-	-	-	-	-	-	-	-	-	-	-
Total lb/hr	89275.00	234,683	1,800	122,118	240,192	3,037	6,074	3,037	552	9,000	86,371	119,081	0	3,037	3,037	7,200	477	1.11E-04	477	
Total std L gpm	156.75	400	N/A	200	400	4.60	9.19	3.68	-	15	150	195	0	5	5	14	1	0	15	
Total std V scfh	1739031.38	-	-	-	-	-	-	-	-	-	-	-	-	-	-	-	-	-	-	-
Liquid Flow in lb/hr																				
Water	73475.81	199,680	0	103,440	203,251	1,814	3,629	1,037	0	7,200	77,580	101,626	0	2,592	2,592	7,200	477	0	477	
OH-	0.00	-	0	64	126	1	2.25	0.64	0	826	48	63	0.00	1.61	2	0	0	0	0	
Cl-	9748.20	20,092	0	10,046	19,740	176	352	101	0	0	7,535	9,870	0	252	252	0	0	0	0	
Ca++	1836.74	3,405	0	2,189	4,302	38	77	22	0	974	1,642	2,151	0	55	55	0	0	0	0	
SO4--	-	0	0	43	84	1	1	0	0	0	32	42	0	1	1	0	0	0	0	
Na+	4214.24	10,014	0	5,096	10,014	89	179	51	0	0	3,822	5,007	0	128	128	0	0	0	0	
Sr++	-	802	0	321	630	6	11	3	0	0	241	315	0	8	8	0	0	0	0	
Ba++	-	160	0	0	0	0	0	0	0	0	0	0	0	0	0	0	0	0	0	
Mg++	-	500	0	8	15	0	0	0	0	0	6	7	0	0	0	0	0	0	0	
Fe++	-	30	0	0	0	0	0	0	0	0	0	0	0	0	0	0	0	0	0	
Total lb/hr	89275.00	234,683	0	121,207	238,162	2,126	4,252	1,215	0	9,000	90,905	119,081	0	3,037	3,037	7,200	477	0	477	
Solids Flow in lb/hr																				
Na2SO4	-	0	0	0	0	0	0	0	552	0	0	0	0	0	0	0	0	0	0	
BaSO4	-	0	0	136	0	136	272	272	0	0	51	0	0	0	0	0	0	0	0	
SrSO4	-	0	0	168	0	168	336	336	0	0	63	0	0	0	0	0	0	0	0	
Ca(OH)2	-	0	1,800	0	0	0	0	0	0	0	0	0	0	0	0	0	0	0	0	
Mg(OH)2	-	0	0	583	0	583	1,166	1,166	0	0	219	0	0	0	0	0	0	0	0	
Fe(OH)2	-	0	0	24	0	24	48	48	0	0	9	0	0	0	0	0	0	0	0	
Total lb/hr	-	0	1,800	911	0	911	1,822	1,822	552	0	342	0	0	0	0	0	0	0	0	

Assumptions:
 Basis for all elemental values come from the analytical results from treatability report unless otherwise noted.
 Raw Brine flow: 400 gpm
 Ca: 17,000ppm
 Cl: 100,000ppm
 Na: 50,000ppm
 Sr: 4,000ppm (assumed 20% removal as SrSO4)
 Ba: 800ppm (assumed 100% removal as BaSO4)
 Mg: 2,500ppm (assumed 97% removal as Mg(OH)2 - based on removal efficiency required to meet ASTM specification for CaCl2 product)
 Fe: 150ppm (assumed 100% removal as Fe(OH)2)
 OH: Based only on the addition of lime.
 Hydrated Lime: 30lb/min (dosing recommendation from treatability study)
 Sodium Sulfate: 9.2lb/min (dosing recommendation from treatability study)
 Stream 105 is based on 30% solids sludge (estimate) and is a batch process.
 Stream 106 is based on 30% solids sludge (estimate) and is a batch process.
 Stream 107 is based on 60% solids sludge (from Evoqua filter press report) and is a batch process.
 Constituents not listed are trace elements that do not make a significant impact on mass flow calculations.
 100% efficiency of the sulfate and hydroxide precipitation.

RELEASED FOR REVIEW AND COMMENT



Fairmont Brine Processing

Venture Engineering & Construction

CONTRACT C12-1110-00 Pittsburgh, PA

FAIRMONT BRINE PROCESSING
FAIRMONT, WV

BRINE PROCESSING PLANT
BRINE PROCESSING
PRE-TREATMENT MASS BALANCE

DRAWING NUMBER **PFD-1001MB** REV. **B**

NO.	REVISION	DWN	CHK	ENG	PM	DATE	NO.	REVISION	DWN	CHK	ENG	PM	DATE	DESIGNED/DWN BY	LK/PC	DATE	10/23/15
		/	/	/	/				/	/	/	/		CHECKED BY	-	DATE	-
		/	/	/	/				/	/	/	/		CHECKED BY ENGR	-	DATE	-
		/	/	/	/				/	/	/	/		APPROVED BY PM	-	DATE	-
		/	/	/	/				/	/	/	/		APPROVED BY MANAGER OF ENGR	-	DATE	-
B	REVISED FOR PRETREAT EXPANSION								JSH	RA	PEV	4/11/16					
A	FOR REVIEW & COMMENT								PC	LK	PEV						
														SCALE	NONE		

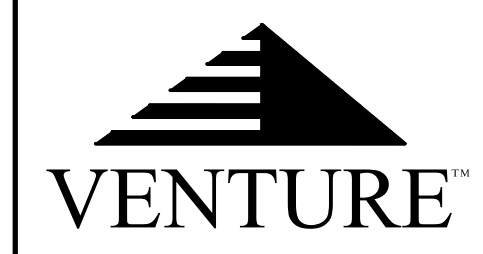

THE DESIGN AND PRINT ARE THE INTELLECTUAL PROPERTY OF VENTURE ENGINEERING & CONSTRUCTION, INC. IT MUST BE RETURNED WITH THE QUOTATION OR UPON DELIVERY OF MATERIAL AND EQUIPMENT AND MUST NOT BE USED IN MANUFACTURING FOR OTHERS EXCEPT BY PERMISSION OF OWNERS.

2001-D-F-F

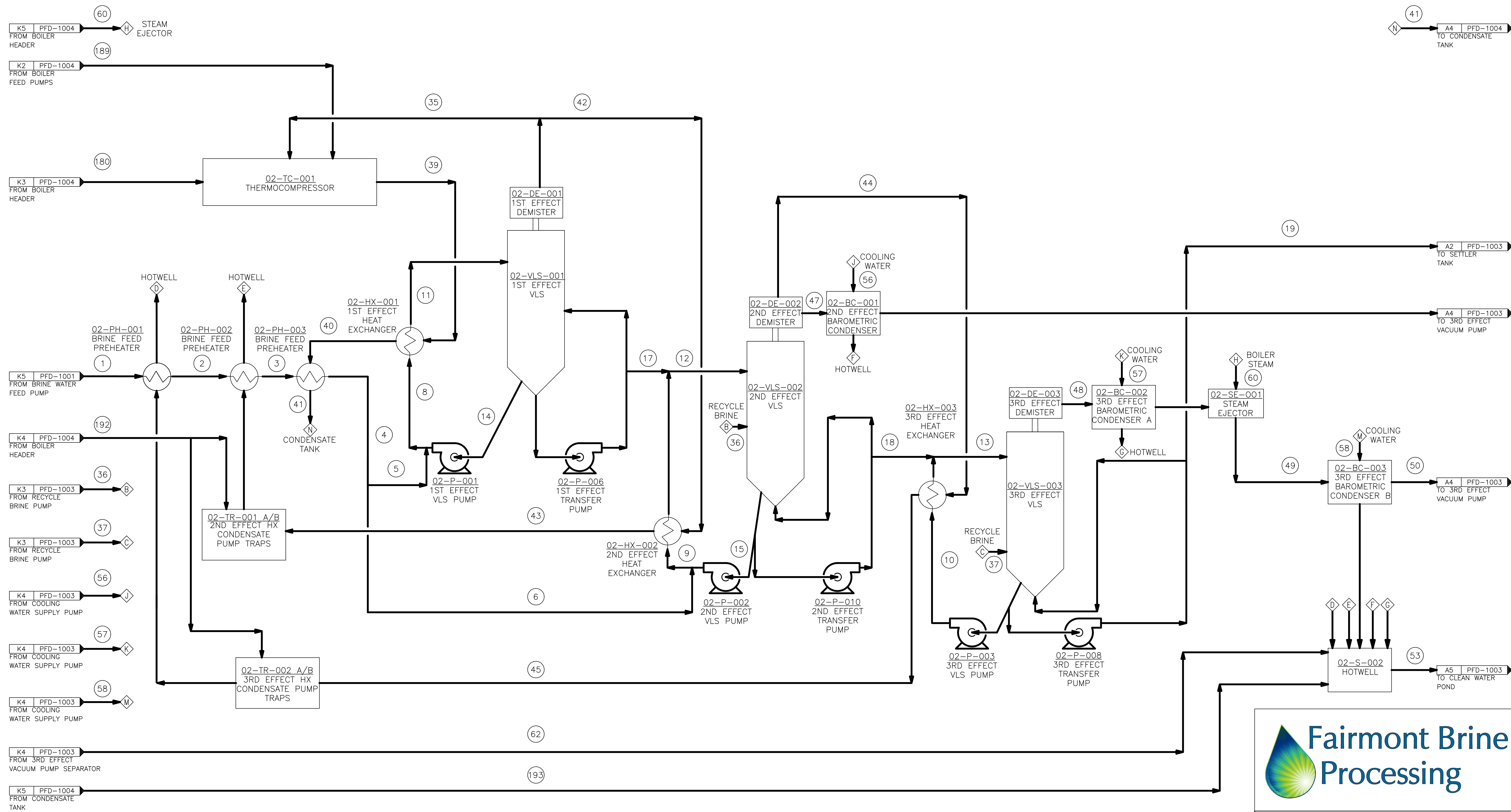

Venture Engineering & Construction
 CONTRACT C12-1110-00 Pittsburgh, PA

FAIRMONT BRINE PROCESSING
 FAIRMONT, WV
 BRINE PROCESSING PLANT
 BRINE PROCESSING
 FLOW DIAGRAM

DRAWING NUMBER **PFD-1002** REV. **C**

RELEASED FOR REVIEW AND COMMENT

THE DESIGN AND PRINT ARE THE INTELLECTUAL PROPERTY OF VENTURE ENGINEERING & CONSTRUCTION, INC. IT MUST BE RETURNED WITH THE QUOTATION OR UPON DELIVERY OF MATERIAL AND EQUIPMENT AND MUST NOT BE USED IN MANUFACTURING FOR OTHERS EXCEPT BY PERMISSION OF OWNERS.



NO.	REVISION	DWN	CHK	ENG	PM	DATE	NO.	REVISION	DWN	CHK	ENG	PM	DATE	DESIGNED/DWN BY	RC	DATE	08/14/14	
														CHECKED BY	RK	DATE	08/14/14	
														CHECKED BY ENGR	RK	DATE	08/14/14	
														APPROVED BY PM	PEV	DATE	08/14/14	
														APPROVED BY MANAGER OF ENGR	KZ	DATE	08/14/14	
														JSH	LK	PEV	04/11/16	
														JSH	LK	PEV	03/10/16	
														RC	RK	KZ	PEV	08/14/14

C REVISED FOR C15120500 PROJECTS
 B REVISED FOR C15120500 PROJECTS
 A FOR REVIEW & COMMENT

SCALE -

PFD-1003

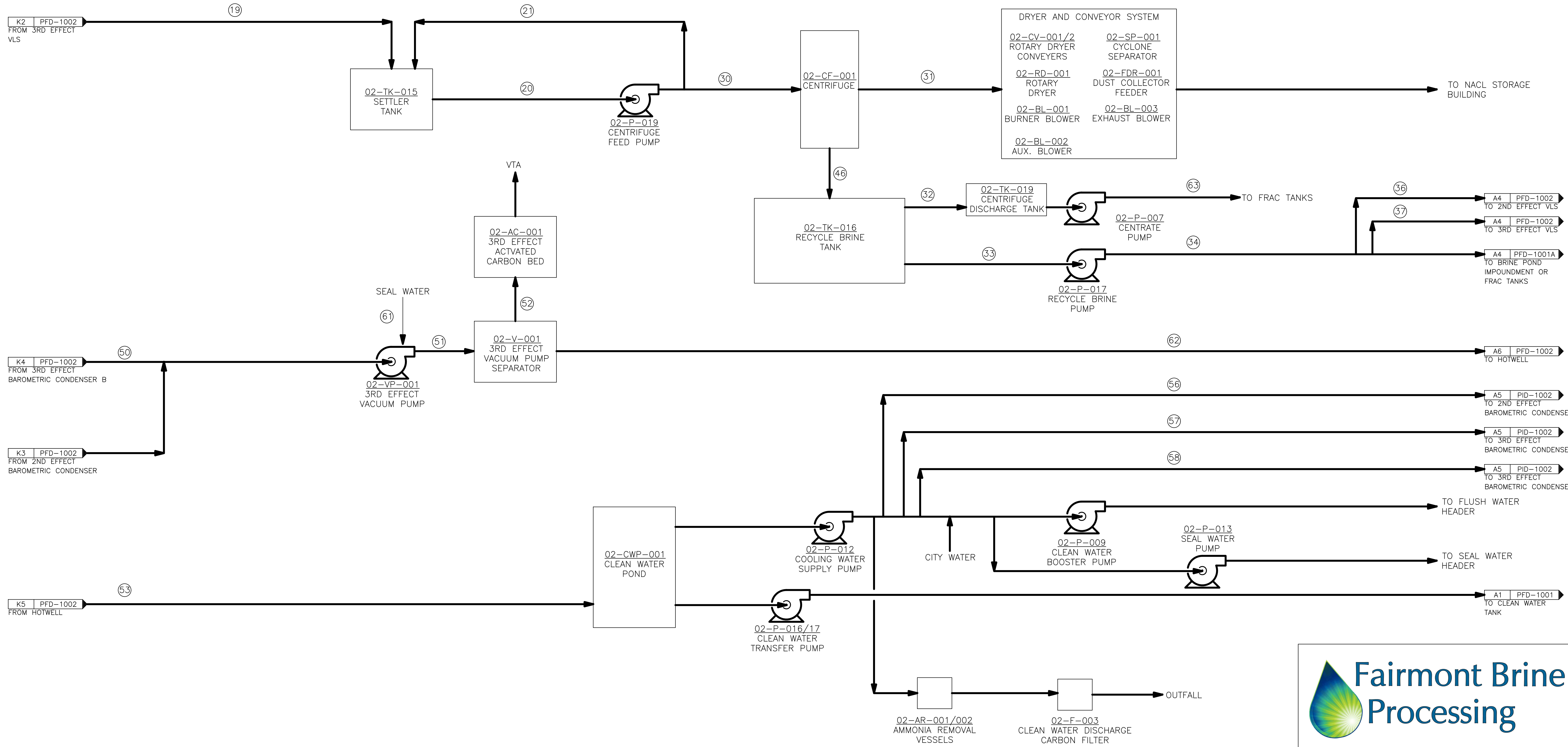

RELEASED FOR REVIEW AND COMMENT



Venture Engineering & Construction
 CONTRACT C12-1110-00 Pittsburgh, PA

FAIRMONT BRINE PROCESSING
 FAIRMONT, WV
 BRINE PROCESSING PLANT
 BRINE PROCESSING
 FLOW DIAGRAM

DRAWING NUMBER **PFD-1003** REV. **C**



NO.	REVISION	DWN	CHK	ENG	PM	DATE	NO.	REVISION	DWN	CHK	ENG	PM	DATE	DESIGNED/DWN BY	RC	DATE	08/14/14
C	REVISED FOR C15120500 PROJECTS								JSH	LK	PEV		04/11/16	APPROVED BY PM	PEV	DATE	08/14/14
B	REVISED FOR C15120500 PROJECTS								JSH	LK	PEV		03/10/16	APPROVED BY MANAGER OF ENGR	KZ	DATE	08/14/14
A	FOR REVIEW & COMMENT								RC	RK	KZ	PEV	08/14/14	SCALE	-		

THE DESIGN AND PRINT ARE THE INTELLECTUAL PROPERTY OF VENTURE ENGINEERING & CONSTRUCTION, INC. IT MUST BE RETURNED WITH THE QUOTATION OR UPON DELIVERY OF MATERIAL AND EQUIPMENT AND MUST NOT BE USED IN MANUFACTURING FOR OTHERS EXCEPT BY PERMISSION OF OWNERS.

PFD-1003MB

Fairmont Brine Processing PFD-1003 Mass Balance	
Project No.:	C15-1205-00
Project Name:	FBP - Debottlenecking and Improvements
Rev.:	D
Rev. Date:	4/11/2016

Stream No.	19	20	21	30	31	32	33	34	36	37	46	50	51	52	53	56	57	58	61	62	63	
ChemCad Ref. No.	36	64	66	67	72	70	71	16	49	50	68	83	85	87	-	41	53	78	82	86	74	
Stream Name	02-VLS-003 Transfer/Feed to 02-TK-015	02-TK-015 Discharge/Feed to 02-P-019	Recirculation to 02-TK-015	Feed to 02-CF-001	Feed to 02-RD-001	02-TK-016 Discharge/Overflow to 02-TK-019	02-TK-016 Discharge/Feed to 02-P-017	02-P-017 Discharge	Recycle to 02-VLS-002	Recycle to 02-VLS-003	02-CF-001 to 02-TK-016	02-BC-003 to 02-VP-001	02-VP-001 to 02-V-001	02-V-001 to 02-AC-001	Hotwell Discharge	02-P-012 to 02-BC-001	02-P-012 to 02-BC-002	02-P-012 to 02-BC-003	Seal Water to 02-VP-001	02-V-001 to Hotwell	To Frac Tanks or Brine Impoundment	
Temp F	149.29	120.00	120.03	120.03	120.03	120.03	120.03	120.16	120.16	120.16	120.03	122.17	90.18	90.93	92.00	90.00	90.00	90.00	90.00	90.00	90.93	120.17
Pres psia	65.00	14.70	25.00	25.00	25.00	14.70	14.70	45.00	45.00	45.00	25.00	14.70	16.70	16.70	14.70	73.60	73.60	73.60	15.00	16.70	45.00	
Enth MMBtu/hr	-289.57	-1150.00	-859.49	-290.49	-45.01	-83.28	-162.20	-26.86	-135.34	-245.48	-0.04	-37.49	-0.01	-5957.90	-5957.90	-85.11	-37.45	-37.48	-83.27	7.35		
Vapor mole frac.	0.00	0.00	0.00	0.00	0.00	0.00	0.00	0.00	0.00	0.00	0.00	1.00	0.00	1.00	0.00	0.00	0.00	0.00	0.00	0.00		
pH value	7.13	7.35	7.35	7.35	7.35	7.35	7.35	7.35	7.35	7.35	7.35	0.00	6.88	0.00	6.88	6.88	6.88	6.88	6.88	6.88		
Ionic str. Molal	18.46	18.48	18.48	18.48	18.48	18.48	18.48	18.48	18.49	18.49	18.48	0.00	0.00	0.00	0.00	0.00	0.00	0.00	0.00	0.00		
Total lbmol/hr	2300.25	9100.27	6801.50	2298.78	290.18	681.38	1327.21	1327.21	219.77	1107.38	2008.59	2.97	308.30	2.72	48575.25	48575.25	693.93	305.33	305.58	681.38		
Total lb/hr	58599.45	231980.52	173381.08	58599.46	12908.12	15500.00	30191.34	30191.34	5000.00	25193.83	45691.34	81.66	5582.18	77.11	1828778.91	875083.00	875083.00	12501.19	5500.52	5505.07	15500.00	
Total std L gpm	78.96	312.46	233.53	78.93	14.20	21.98	42.82	42.82	7.09	35.72	64.80	0.46	11.46	0.45	1750.00	1750.00	25.00	11.00	11.01	21.98		
Total std V scfh	872897.00	3453357.50	2581022.75	872336.00	110117.79	258569.41	503648.75	503648.75	83399.02	420228.16	762218.19	1127.66	116993.91	1032.66	18433268.00	18433268.00	263332.41	115866.26	115961.26	258569.41		
Flow rates in lb/hr																						
Water	28634.67	113264.80	84653.54	28611.27	1530.12	9186.81	17894.33	17894.33	2962.54	14927.57	27081.14	6.55	5507.08	2.11	1828755.64	875083.00	875083.00	12501.19	5500.52	5504.96	9186.81	
Sodium Chloride	10282.77	40880.23	30553.51	10326.50	10326.50	0.00	0.00	0.00	0.00	0.00	0.00	0.00	0.00	0.00	0.00	0.00	0.00	0.00	0.00	0.00	0.00	
Calcium Chloride	0.00	0.00	0.00	0.00	0.00	0.00	0.00	0.00	0.00	0.00	0.00	0.00	0.00	0.00	0.00	0.00	0.00	0.00	0.00	0.00	0.00	
Oxygen	0.00	0.00	0.00	0.00	0.00	0.00	0.00	0.00	0.00	0.00	16.46	16.46	16.42	5.14	0.00	0.00	0.00	0.00	0.00	0.04	0.00	
Nitrogen	0.00	0.00	0.00	0.00	0.00	0.00	0.00	0.00	0.00	0.00	58.64	58.64	58.57	17.87	0.00	0.00	0.00	0.00	0.00	0.07	0.00	
H+	0.00	0.00	0.00	0.00	0.00	0.00	0.00	0.00	0.00	0.00	0.00	0.00	0.00	0.00	0.00	0.00	0.00	0.00	0.00	0.00	0.00	
OH-	0.00	0.00	0.00	0.00	0.00	0.00	0.00	0.00	0.00	0.00	0.00	0.00	0.00	0.00	0.00	0.00	0.00	0.00	0.00	0.00	0.00	
Cl-	12546.02	49621.00	37086.58	12534.55	670.34	4024.73	7839.48	7839.48	1298.90	6544.84	11864.20	0.00	0.00	0.00	0.00	0.00	0.00	0.00	0.00	0.00	4024.73	
Ca++	6979.85	27678.17	20686.53	6991.65	373.91	2244.95	4372.78	4372.78	724.56	3650.90	6617.74	0.00	0.00	0.00	0.00	0.00	0.00	0.00	0.00	0.00	2244.95	
Na+	156.15	536.33	400.92	135.50	7.25	43.51	84.75	84.75	14.00	70.52	128.26	0.00	0.00	0.00	0.00	0.00	0.00	0.00	0.00	0.00	43.51	

Notes:
 Based on ChemCAD simulation entitled FBP - C15120500 - 160411.ccb
 PFD Stream 53 is the summation of ChemCAD Streams 29 (PH-1 to HW), 18 (PH-2 to HW), 45 (BC-1 to HW), 80 (BC-2 to HW), 81 (BC-3 to HW), and 86 (V-1 to HW) plus PFD Streams 192 (Boiler steam to Condensate Pump Traps) and 193 (Condensate Tank to HW).
 Flow rates within +/-0.1% accuracy based on allowable tolerances in ChemCAD simulation.

RELEASED FOR REVIEW AND COMMENT



Venture Engineering & Construction
 CONTRACT C12-1110-00 Pittsburgh, PA

FAIRMONT BRINE PROCESSING
 FAIRMONT, WV
 BRINE PROCESSING PLANT
 BRINE PROCESSING
 MASS BALANCE
 DRAWING NUMBER **PFD-1003MB** REV. **D**

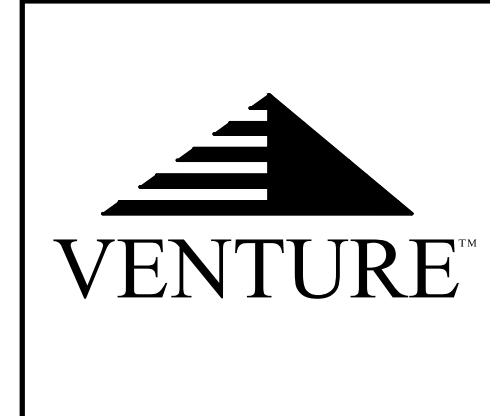

NO.	REVISION	DWN	CHK	ENG	PM	DATE	NO.	REVISION	DWN	CHK	ENG	PM	DATE	DESIGNED/DWN BY	DATE	CHECKED BY	DATE	APPROVED BY PM	DATE	APPROVED BY MANAGER OF ENGR	DATE
														LK/JSH	03/14/16	-	-	-	-	-	-
														-	-	-	-	-	-	-	-
														JSH	04/11/16	-	-	-	-	-	-
														JSH	03/14/16	-	-	-	-	-	-
															NONE						

THE DESIGN AND PRINT ARE THE INTELLECTUAL PROPERTY OF VENTURE ENGINEERING & CONSTRUCTION, INC. IT MUST BE RETURNED WITH THE QUOTATION OR UPON DELIVERY OF MATERIAL AND EQUIPMENT AND MUST NOT BE USED IN MANUFACTURING FOR OTHERS EXCEPT BY PERMISSION OF OWNERS.

PFD-1004

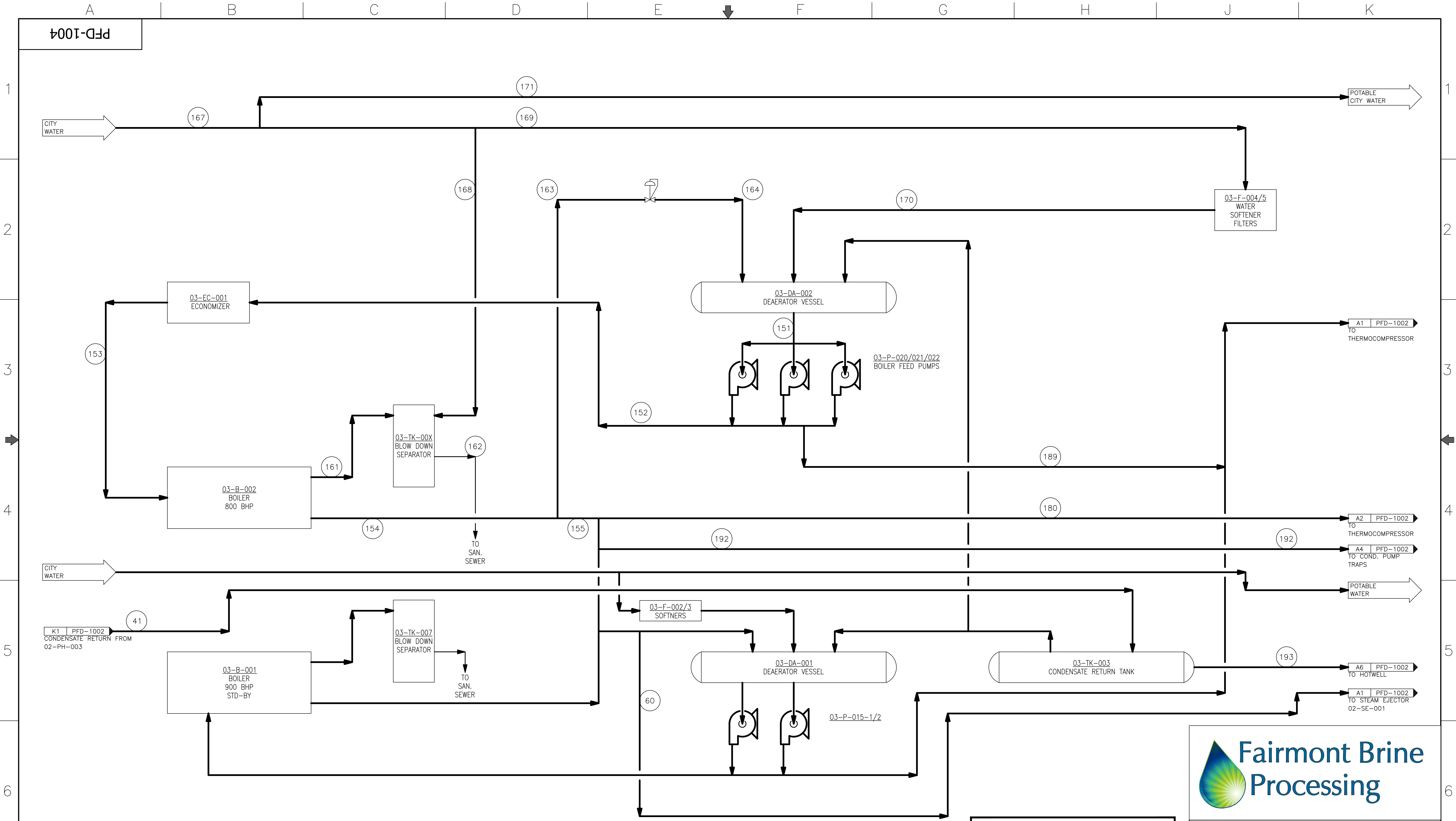

RELEASED FOR REVIEW AND COMMENT



Venture Engineering & Construction

CONTRACT C12-1110-00 Pittsburgh, PA

FAIRMONT BRINE PROCESSING
FAIRMONT, WV
BRINE PROCESSING PLANT
WATER & STEAM
FLOW DIAGRAM

DRAWING NUMBER **PFD-1004** REV. **D**



NO.	REVISION	DWN	CHK	ENG	PM	DATE	NO.	REVISION	DWN	CHK	ENG	PM	DATE	DESIGNED/DWN BY	JWR	DATE	2/10/2016
														CHECKED BY	GK	DATE	3/3/2016
														CHECKED BY ENGR	MLO	DATE	-
							D	REVISED FOR AIR PERMIT RFD	PC	LDK	PEV		5/9/16	APPROVED BY PM	PEV	DATE	-
							C	REVISED FOR C15120503 BOILER SYSTEM RELIABILITY IMPROVEMENTS	JSH	MLO	PEV		04/12/16	APPROVED BY MANAGER OF ENGR	-	DATE	-
							B	REVISED FOR C15120503 BOILER SYSTEM RELIABILITY IMPROVEMENTS	JSH	MLO	PEV		03/17/16				
							A	FOR REVIEW & COMMENT	JWR	PC	MLO	PEV		SCALE	-		

THE DESIGN AND PRINT ARE THE INTELLECTUAL PROPERTY OF VENTURE ENGINEERING & CONSTRUCTION, INC. IT MUST BE RETURNED WITH THE QUOTATION OR UPON DELIVERY OF MATERIAL AND EQUIPMENT AND MUST NOT BE USED IN MANUFACTURING FOR OTHERS EXCEPT BY PERMISSION OF OWNERS.

PFD-1004MB

Fairmont Brine Processing PFD Mass Balance	
Project No.:	C15-1205-03
Project Name:	Fairmont Brine Processing
Rev.:	D
Rev. Date:	5/9/2016

Water and Steam New Boiler

Basis: 22,655 Steam Flow to Thermo-Compressor

Stream No.	41	60	151	152	153	154	155	161	162	163	164	167	168	169	170	171	180
Stream Name	STEAM CONDENSATE RETURN	STEAM TO THE EJECTOR	BOILER FEED WATER	BOILER FEED WATER	BOILER FEED WATER	285 PSIA STEAM	285 PSIA STEAM	BOILER BLOW DOWN	BOILER BLOW DOWN	285 PSIA STEAM	20 PSIA STEAM	CITY WATER	CITY WATER	CITY WATER	SOFTENED CITY WATER	POTABLE CITY WATER	285 PSIA STEAM
Temp F	176.79	414.2	235.0	235.0	315.0	414.2	414.2	414.2	110.0	414.2	228.0	60.0	60.0	60.0	60.0	60.0	414.2
Pres psia	47.5	289.7	19.7	314.7	295.0	289.7	289.7	289.7	1.3	289.7	19.7	0.3	0.3	0.3	0.3	0.3	289.7
Enth MMBtu/hr	-211.0	-1.08	5.2	5.1	7.1	28.4	27.6	0.5	0.7	0.8	0.8	0.6	0.2	0.0	0.0	0.1	-128.2
Total lb/hr	31,385.0	190.0	25,374.0	24,873.0	24,873.0	23,623.0	22,923.0	1,250.0	8,756.0	700.0	700.0	20,016.0	7,506.0	0.0	0.0	5,004.0	22,655.0
Total std L gpm	62.76		50.7	49.7	49.7			2.5	17.5			40.0	15.0	0.0	0.0	10.0	

Stream No.	189	192	193														
Stream Name	BOILER FEED WATER	Boiler stm to condensate pump traps	Condensate Tank to Hot well														
Temp F	235.0	414.2															
Pres psia	315.0	289.7															
Enth MMBtu/hr	0.2																
Total lb/hr	501.0	78.0	6,711.0														
Total std L gpm	1.0		13.4														

RELEASED FOR REVIEW AND COMMENT



Venture Engineering & Construction
 CONTRACT C12-1110-00 Pittsburgh, PA

FAIRMONT BRINE PROCESSING
 FAIRMONT, WV
 BRINE PROCESSING PLANT
 WATER & STEAM
 MASS BALANCE

DRAWING NUMBER **PFD-1004MB** REV. **D**



NO.	REVISION	DWN	CHK	ENG	PM	DATE	NO.	REVISION	DWN	CHK	ENG	PM	DATE	DESIGNED/DWN BY	DATE	CHECKED BY	DATE	CHECKED BY ENGR	DATE	APPROVED BY PM	DATE	APPROVED BY MANAGER OF ENGR	DATE	SCALE
														JWR	2/10/2016	GK	3/3/2016	MLO	-	PEV	-	-	-	NONE
D	REVISED FOR AIR PERMIT RFD								PC		LDK		5-9-16											
C	REVISED FOR C15120503 BOILER SYSTEM RELIABILITY IMPROVEMENTS								JSH		MLO		04/11/16											
B	REVISED FOR C15120503 BOILER SYSTEM RELIABILITY IMPROVEMENTS								JSH		MLO		03/16/16											
A	FOR REVIEW & COMMENT								JWR		PC													

THE DESIGN AND PRINT ARE THE INTELLECTUAL PROPERTY OF VENTURE ENGINEERING & CONSTRUCTION, INC. IT MUST BE RETURNED WITH THE QUOTATION OR UPON DELIVERY OF MATERIAL AND EQUIPMENT AND MUST NOT BE USED IN MANUFACTURING FOR OTHERS EXCEPT BY PERMISSION OF OWNERS.



ATTACHMENT C

DETAILED PROCESS DESCRIPTION



Fairmont Brine Processing, LLC

168 AFR Drive

Fairmont, WV

Type of Business

The Fairmont Brine Processing, LLC, West Virginia Water Treatment Facility produces distilled water for use in natural gas well development. The source water used is from natural gas well development and production. The source water is pretreated at the facility to remove oil and suspended solids. Following pretreatment, the water is processed to remove dissolved solids to a concentration of less than five hundred (500) mg/L.

The treated water is sold to primarily natural gas well drilling companies. The sodium and calcium chloride salts removed from the water are sold as products.

Facility History

This facility was originally permitted by AOP-Clearwater, LLC. The original application was submitted to WVDEP in December 2008 by MSES Consultants, Inc. on behalf of AOP-Clearwater, LLC. Permit R13-2794 was issued to AOP-Clearwater, LLC on May 12, 2009. The property was transferred from AOP to Fairmont Brine Processing (FBP) on March 28, 2012 and Permit R13-2794 was transferred to FBP on April 25, 2012. The plant was idle at the time of transfer. Prior to operating under FBP, a Request for Determination (RFD) was submitted on February 5, 2014 by Venture Engineering & Construction, Inc. on behalf of FBP. Based on this submittal, WVDEP determined that a permit was not required under 45CSR13. FBP has been operating under Permit R13-2794. At this time, the following proposed process/facility changes necessitate an additional RFD:

- Modify Source E-3: FBP plans to replace the existing third effect heat exchanger, 02-HX-003, which will allow for an increase in plant capacity. This change will increase Emissions E-3.
- Add Source S-6: FBP plans to expand their pretreatment operations to include chemical precipitation, clarification, and effluent and sludge processing. This includes the installation of a lime silo, 01-TK-015 (new Emissions E-6).
- Add Source S-7: FBP plans to install a second natural gas fueled boiler, 03-B-002 (new Emissions E-7) to provide a redundant heat source for the evaporation process.

NOTE: AOP-Clearwater, LLC included an emergency generator (Emissions E-5) on the original permit application. An emergency generator was not installed and FBP has no plans at this time to install an emergency generator.



Process Description

The FBP plant consists of three main processing operations: Brine Treatment, Evaporation and Crystallization. The three processes are described below.

Brine Treatment

The facility receives untreated brine water with limited (less than 0.1%) crude oil, suspended solids, and dissolved solids by tank trucks. After arrival and before unloading (unless previously characterized), the contents of the trucks are sampled and tested for chemical composition and physical properties. The trucks are unloaded on a concrete pad with the untreated brine water transferred to a concrete lined basin. The quantity of water is stored in a computer database for further correspondence. Oil is removed by an oil skimmer from the top of the basin and stored in an oil storage tank (Emissions E-4).

The treated brine water flows from the basin to the oil/water separator for oil removal to the oil storage tank. From the oil/water separator the treated brine water is currently pumped through bag filters for solids removal and then through activated carbon filters to remove the organics. Prior to filtration, FBP proposes to chemically treat the brine water using sodium sulfate (which is currently added to the basin) and two new treatment chemicals: hydrated lime and polymer (for increased flocculation). Hydrated lime will be stored in a lime silo (Emissions E-6). With the pretreatment process upgrades, the treated brine water will be pumped from the oil/water separator through a series of new chemical addition tanks where chemical dosing will occur to enable heavy metal precipitation.

Following chemical treatment, FBP plans to clarify the brine water using two inclined-plate clarifiers operating in parallel. The clarification system will include sludge handling equipment. With these changes, the treated brine water will flow from the chemical addition tanks through the clarifiers and into a new effluent storage tank. The treated brine water will be pumped from the effluent storage tank through the existing bag and activated carbon filters. Finally, the brine water from the pretreatment process will flow into the existing 5.25 million gallon HDPE lined brine pond impoundment allowing additional mixing and capacity prior to the evaporation process.

The sludge from the clarifiers will be pumped into a new thickener vessel and then filter pressed. The overflow from the thickener and filtrate from the new filter press will be returned to the clarifiers for reprocessing.

The solid waste generated will be disposed of via landfill. The oil is stored in the oil storage tank for external sale.



Evaporation

The brine water from the brine pond impoundment is currently processed at a rate of approximately 5,000 barrels per day to remove dissolved solids. With the replacement of the third effect heat exchanger, the process rate will increase to approximately 5,400 barrels per day. The heat source for the process is steam produced by a 30 million Btu per hour natural gas fueled boiler (Emissions E-1). FBP plans to install an additional 27 million Btu per hour natural gas fueled boiler (Emissions E-7) for redundant heat sources. The boilers cannot operate concurrently.

The brine water from the brine pond impoundment is pumped through bag filters and heat exchangers to preheat the brine water for processing. The brine water feed is then pumped to vapor liquid separators (VLSs) for evaporation. In the VLSs the brine water is concentrated as the distilled water is evaporated out the top of the vessel, passing through a mist eliminator vessel. A recirculating stream is pumped through the first effect heat exchanger and heated to allow vaporization of clean water from the brine water in the VLS. The water vapors from the first effect VLS continue to the second effect heat exchanger, which heats the recirculating brine in the second effect VLS system. The second effect VLS operates in the same manner as the first effect VLS where the water vapor from the top of the second VLS flows to the third effect heat exchanger for the recirculating of brine water to the third effect VLS. The brine water is delivered to the first and second VLSs in a parallel feed flow. Hence, the FBP plant has three vapor liquid separators with two operating in parallel for the process stream and three operating in series for efficient steam energy utilization.

The distilled water vapors from this process are condensed in the downstream heat exchangers and in a barometric condenser system. The distilled water is delivered to a hot well for delivery and storage in the existing 1.25 million gallon clean water pond.

The non-condensable vapors from the barometric condenser system and from mist eliminator lines are pumped through a vacuum pump separator and an activated carbon bed to atmosphere (Emissions E-3).



Crystallization

Salt crystallization begins in the VLSs as the water is evaporated and the concentration of the remaining brine exceeds the saturation point of the brine water solution. A salt crystal bearing brine water slurry is transferred between evaporators and then removed as a single stream leaving the third effect VLS. The slurry is pumped to the settler tank where continued salt formation occurs before it is transferred to the centrifuge. The salt crystals are separated from the concentrated brine water in the centrifuge and are then fed via a conveyor to a natural gas fueled rotary dryer (Emissions E-2). The wet salt cake from the conveyor is dried in the rotary dryer and then conveyed to a storage pile to await customer distribution. The concentrated brine water from the centrifuge is returned to the second and third effect VLSs for continued processing, as well as pumped to CaCl_2 storage for external sale.



ATTACHMENT D

MATERIAL SAFETY DATA SHEETS



The following MSDSs are provided as ATTACHMENT D:

Brine Treatment

- Untreated Brine
- Sodium Sulfate
- Hydrated Lime (NEW)
- Anionic Emulsion Polymer (NEW; MSDS provided for example only. Polymer selection is pending.)
- Pretreated Brine

Evaporation

- Defoamer
- Sodium Hydroxide (Use may be discontinued once process changes to use hydrated lime are implemented.)
- ISOPLUS – Boiler treatment
- CONDEN-SAF 4675 – Condensate Treatment
- Dubois OH 50 – Alkaline Builder
- ZT-65 – Water Softener Cleaning

Crystallization

- Heavy Brine
- Process Salt

MATERIAL SAFETY DATA SHEET

UNTREATED BRINE

FILE NO.:
MSDS DATE: 10/28/2015

SECTION 1: PRODUCT AND COMPANY IDENTIFICATION

PRODUCT NAME: UNTREATED BRINE
SYNONYMS: RAW WASTEWATER, BRINE SOLUTION, PRODUCED WATER, FORMATION WATER, FRACTIONATION WATER
PRODUCT CODES: N/A

MANUFACTURER: FAIRMONT BRINE PROCESSING, LLC
DIVISION: N/A
ADDRESS: 168 AFR DRIVE | FAIRMONT, WV 26554

EMERGENCY PHONE: (412) 680-6244
CHEMTREC PHONE: (800) 424-9300 (24 HOURS)
OTHER CALLS: (304) 363-9876
FAX PHONE: (412) 231-5891

CHEMICAL NAME: BRINE SOLUTION
CHEMICAL FAMILY: MIXTURE
CHEMICAL FORMULA: MIXTURE

PRODUCT USE: EVAPORATION/ CRYSTALLIZATION
PREPARED BY: LDK

SECTION 1 NOTES: Raw wastewater from incoming trucks (various producers)

SECTION 2: COMPOSITION/INFORMATION ON INGREDIENTS

<u>INGREDIENT</u>	<u>CAS NO.</u>	<u>% WT</u>
Water	7732-18-5	80-95
Calcium chloride	10043-52-4	0-10
Potassium chloride	7447-40-7	0-10
Sodium chloride	7647-14-5	0-10
Residual metals	Various	<5
Benzene	71-43-2	<1

SECTION 3: HAZARDS IDENTIFICATION

EMERGENCY OVERVIEW: WARNING! Causes eye irritation. The product may contain benzene which may cause cancer and cause blood disorders.

ROUTES OF ENTRY: Eye contact. Skin contact. Ingestion. Inhalation.

POTENTIAL HEALTH EFFECTS

EYES: Causes eye irritation

SKIN: Prolonged or repeated skin contact may cause irritation.

INGESTION: May cause gastrointestinal irritation, nausea, vomiting and diarrhea

INHALATION: No inhalation hazard under normal conditions. If misting occurs: may cause mild mucous membrane irritation of the nose, throat, and upper respiratory tract.

ACUTE HEALTH HAZARDS: Causes eye irritation.

CHRONIC HEALTH HAZARDS: May contain benzene. Human epidemiology studies indicate that prolonged and/or repeated overexposure to benzene may cause damage to the blood-producing system and serious blood disorders, including leukemia. Animal tests suggest that prolonged and/or repeated overexposure to benzene may damage the embryo/fetus. The relevance of these animal studies to humans has not been fully established.

CARCINOGENICITY

This product is not considered to be a carcinogen by IARC, ACGIH, NTP, or OSHA.

OSHA:	Benzene (CAS 71-43-2)	Cancer hazard
ACGIH:	Benzene (CAS 71-43-2)	A1 Confirmed human carcinogen
NTP:	Benzene (CAS 71-43-2)	Known carcinogen
IARC:	Benzene (CAS 71-43-2)	1 Carcinogenic to humans

MATERIAL SAFETY DATA SHEET

UNTREATED BRINE

FILE NO.:
MSDS DATE: 10/28/2015

SECTION 4: FIRST AID MEASURES

EYES: In case of contact, immediately flush eyes with fresh water for at least 15 minutes while holding the eyelids open. Remove contact lenses if worn. Get medical attention if irritation persists.

SKIN: Remove contaminated clothing and shoes. Wash affected area with mild soap and water. Get medical attention if irritation develops and persists.

INGESTION: Rinse mouth thoroughly. Get medical attention if any discomfort occurs

INHALATION: If breathing is difficult, remove to fresh air and keep at rest in a position comfortable for breathing. Call a physician if symptoms develop or persist.

SECTION 4 NOTES: If you feel unwell, seek medical advice (show the label where possible). Ensure that medical personnel are aware of the material(s) involved, and take precautions to protect themselves.

SECTION 5: FIRE-FIGHTING MEASURES

FLAMMABLE PROPERTIES: This product is not flammable; however sufficient hydrocarbon vapors may accumulate from oil or natural gas condensate floating on the surface of the produced water to cause a flash fire. The fire should burn out fairly rapidly depending on the amount of oil and natural gas condensate floating on the surface of the produced water.

EXTINGUISHING MEDIA

SUITABLE EXTINGUISHING MEDIA: Dry chemical powder. Foam. Carbon dioxide (CO₂).

PROTECTION OF FIREFIGHTERS

PROTECTIVE EQUIPMENT AND PRECAUTIONS FOR FIREFIGHTERS: A fire would be associated with vapors related to oil or natural gas condensate floating on the surface of the produced water. Water maybe ineffective on flames and may even spread the fire but should be used to cool pressurized containers in the fire.

SPECIAL PROTECTIVE EQUIPMENT FOR FIREFIGHTERS:

Firefighters should wear appropriate protective equipment and self-contained breathing apparatus (SCBA) with full face-piece operated in positive pressure mode. Use approved gas detectors in confined spaces.

SPECIFIC METHODS: Promptly isolate the scene by removing persons from the vicinity of the incident if there is a fire. Do not extinguish flames at leak because of the possibility of a uncontrolled re-ignition exists. If it is safe to do so, cut off fuel supply and/or allow fire to burn out. The fire should burn out fairly rapidly depending on the amount of oil and natural gas condensate floating on the surface of the produced water. If leak or spill has not ignited, water spray or ventilation can be used to disperse the vapors.

HAZARDOUS COMBUSTION PRODUCTS: Sodium oxides. Carbon oxides.

SECTION 6: ACCIDENTAL RELEASE MEASURES

ACCIDENTAL RELEASE MEASURES: Recover by pumping (use an explosion-proof motor or hand pump) or by sand or other oil absorbing materials. Carefully shovel, scoop or sweep up into a waste container for reclamation or disposal. Where feasible and appropriate, remove contaminated soil or flush with fresh water. On water spills utilize absorbent material to remove oil and natural gas liquid from the surface of the water.

SECTION 6 NOTES: Avoid excess skin contact with spilled material.

SECTION 7: HANDLING AND STORAGE

HANDLING: Avoid contact with skin, eyes and clothing. Wash thoroughly after handling.

STORAGE: Keep containers in well-ventilated area away from flame, sparks, excessive temperatures and open flames. Keep the containers closed and clearly labeled. Empty product containers or vessels may contain vapors. Do not pressurize, cut, heat, weld or expose such containers to sources of ignition. Do not enter storage areas and confined spaces without adequate ventilation. Use appropriate respiratory protection if there is the potential to exceed the exposure limit(s). Vapors containing benzene may accumulate during storage and transport.

SECTION 8: EXPOSURE CONTROLS/PERSONAL PROTECTION

VENTILATION: Ensure adequate ventilation, especially in confined areas.

RESPIRATORY PROTECTION: No personal respiratory equipment normally required.

EYE PROTECTION: If eye contact is likely, safety glasses should be worn.

MATERIAL SAFETY DATA SHEET
UNTREATED BRINE

FILE NO.:
MSDS DATE: 10/28/2015

SECTION 8: EXPOSURE CONTROLS/PERSONAL PROTECTION (Continued)

SKIN PROTECTION: No special garments required. Wash contaminated clothing prior to reuse.

OTHER PROTECTIVE CLOTHING OR EQUIPMENT: No other protective clothing or equipment is needed.

WORK HYGIENIC PRACTICES: Always observe good personal hygiene measures, such as washing after handling the material and before eating, drinking, and/or smoking. Routinely wash work clothing and protective equipment to remove contaminants. Discard contaminated clothing and footwear that cannot be cleaned. Handle in accordance with good industrial hygiene and safety practice.

SECTION 9: PHYSICAL AND CHEMICAL PROPERTIES

APPEARANCE: Dirty colored liquid

ODOR: Faint hydrocarbon odor

PHYSICAL STATE: Liquid

pH AS SUPPLIED: 4.5-7.5
pH (Other):

BOILING POINT:

F: 212°

C: 100°

MELTING POINT:

F: N/A

C: N/A

FREEZING POINT:

F: < 32°

C: < 0°

VAPOR PRESSURE (mmHg): 13.6 (approx.)

@ F: 68°

C: 20°

VAPOR DENSITY (AIR = 1): <1

@ F: 68°

C: 20°

SPECIFIC GRAVITY (H₂O = 1): 1.2 (approx.)

@ F: 68°

C: 20°

EVAPORATION RATE: N/A

SOLUBILITY IN WATER: Complete

PERCENT SOLIDS BY WEIGHT: N/A

PERCENT VOLATILE: N/A

BY WT/ BY VOL @

F:

C:

VOLATILE ORGANIC COMPOUNDS (VOC): N/A

WITH WATER: LBS/GAL

WITHOUT WATER: LBS/GAL

MOLECULAR WEIGHT: N/A

SECTION 10: STABILITY AND REACTIVITY

STABILITY: Stable

CONDITIONS TO AVOID (STABILITY): Keep away from heat, sparks, and open flame.

HAZARDOUS DECOMPOSITION OR BY-PRODUCTS: Carbon dioxide. Water vapor. May produce oxides of sulfur. Carbon monoxide via incomplete combustion.

HAZARDOUS POLYMERIZATION: Does not occur.

MATERIAL SAFETY DATA SHEET

UNTREATED BRINE

CONDITIONS TO AVOID (POLYMERIZATION): N/A

FILE NO.:

MSDS DATE: 10/28/2015

SECTION 11: TOXICOLOGICAL INFORMATION

TOXICOLOGICAL INFORMATION: This product may contain detectable but varying quantities of the naturally occurring radioactive substance Radium 226/228. Due to the long half life of Radium 226/228 (1600yr/5.75yr), there should not be significant radiation. The solution may cause eye and skin irritation.

SECTION 12: ECOLOGICAL INFORMATION

ECOLOGICAL INFORMATION: An environmental hazard cannot be excluded in the event of unprofessional handling or disposal.

SECTION 12 NOTES: To be expected to be harmful to aquatic organisms.

SECTION 13: DISPOSAL CONSIDERATIONS

WASTE DISPOSAL METHOD: Reuse or recycle if possible. All disposal practices must be in compliance with all Federal, State/Provincial and local laws and regulations. Regulations may vary in different locations. Waste characterizations and compliance with applicable laws are the responsibility solely of the waste generator. AS YOUR SUPPLIER, WE HAVE NO CONTROL OVER THE MANAGEMENT PRACTICES OR MANUFACTURING PROCESSES OF PARTIES HANDLING OR USING THIS MATERIAL. THE INFORMATION PRESENTED HERE PERTAINS ONLY TO THE PRODUCT AS SHIPPED IN ITS INTENDED CONDITION AS DESCRIBED IN MSDS SECTION: Composition Information. FOR UNUSED & UNCONTAMINATED PRODUCT, the preferred options include sending to a licensed, permitted: Reclaimer. Waste water treatment system.

SECTION 14: TRANSPORT INFORMATION

U.S. DOT 49 CFR 172.101:

Status: Not regulated

CANADIAN TRANSPORTATION OF DANGEROUS GOODS:

Status: Not regulated

OTHER AGENCIES:

SECTION 15: REGULATORY INFORMATION

U.S. REGULATIONS

OSHA REGULATORY STATUS: This material is considered hazardous by the OSHA Hazard Communication Standard (29 CFR 1910.1200)

CERCLA SECTIONS 102a/103 HAZARDOUS SUBSTANCES (40 CFR 302.4): Not regulated.

EPCRA EXTREMELY HAZARDOUS SUBSTANCES (40 CFR 355.30): Not regulated.

EPCRA SECTIONS 311/312 HAZARD CATEGORIES (40 CFR 370.10): Acute Health Hazard

EPCRA SECTION 313 (40 CFR 372.65): To the best of our knowledge, this product does not contain chemicals at levels which require reporting under this statute.

OSHA PROCESS SAFETY (PSM) (29 CFR 1910.119): Not regulated.

STATE REGULATIONS:

INTERNATIONAL REGULATIONS:

SECTION 16: OTHER INFORMATION

IMPORTANT:

The information presented herein, while not guaranteed, was prepared by technical personnel and is true and accurate to the best of our knowledge. **NO WARRANTY OF MERCHANTABILITY OR OF FITNESS FOR A PARTICULAR PURPOSE, OR WARRANTY OR GUARANTY OF ANY OTHER KIND, EXPRESS OR IMPLIED, IS MADE REGARDING PERFORMANCE, SAFETY, SUITABILITY, STABILITY OR OTHERWISE.** This information is not intended to be all-inclusive as to the manner and conditions of use, handling, storage, disposal and other factors that may involve other or additional legal, environmental, safety or performance considerations, and OxyChem assumes no liability whatsoever for the use of or reliance upon this information. While our technical personnel will be happy to respond to questions, safe handling and use of the product remains the responsibility of the customer. No suggestions for use are intended as, and nothing herein shall be construed as, a recommendation to infringe any existing patents or to violate any Federal, State, local or foreign laws. OSHA Standard 29 CFR 1910.1200 requires that information be provided to employees regarding the hazards of chemicals by means of a hazard communication program including labeling, safety data sheets, training and access to written records. We request that you, and it is your legal duty to, make all information in this Safety Data Sheet available to your employees.

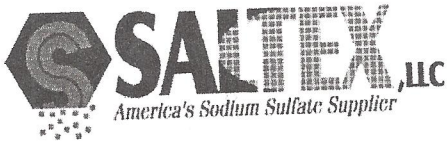

Saltex, LLC
7755 Bellaire South
Ft. Worth, TX 76132
USA Tel:
877-872-5839

MATERIAL SAFETY DATA SHEET
SODIUM SULFATE ANHYDROUS
January 1, 2013

SECTION I: CHEMICAL PRODUCT AND COMPANY INFORMATION

Product Name: Sodium Sulfate
General Use:
Common Synonyms: Sodium sulfate, Anhydrous; Sulfuric Acid, Disodium Salt;
Disodium Sulfate
Chemical Family: Neutral Salts
Formula: Na₂SO₄
Formula Weight: 142.04
CAS No.: 7757-82-6
Manufacturer: Saltex, LLC

SECTION II: COMPOSITION/INFORMATION ON INGREDIENTS

<u>Component</u>	<u>WEIGHT %</u>	<u>CAS #</u>
Sodium Sulfate, Anhydrous	99 - 100	7757-82-6

<u>Component</u>	<u>Hazard</u>	<u>OSHA STEL</u>	<u>OSHA PEL</u>	<u>ACGIH TLV</u>
Sodium Sulfate, Anhydrous	Irritant	N/E	N/E	N/E

EXTENDED INFORMATION

SECTION III: HAZARDS IDENTIFICATION

EMERGENCY OVERVIEW

CAUTION! MAY CAUSE IRRITATION. MAY BE HARMFUL IF SWALLOWED OR INHALED. HYGROSCOPIC. During use avoid contact with eyes, skin or clothing. Wash thoroughly after handling. When not in use, keep in tightly closed container.

POTENTIAL HEALTH EFFECTS

EYE CONTACT: Irritation
SKIN CONTACT: Irritation
INGESTION: Gastrointestinal irritation
INHALATION: Irritation of the upper respiratory tract.
CHRONIC: None identified
TARGET ORGANS: Respiratory system, lungs.

Sodium Sulfate

Primary routes of entry:

Inhalation

Ingestion

Skin Contact

Eye Contact

MEDICAL CONDITIONS AGGRAVATED BY EXPOSURE: None identified

SECTION III: FIRST AID MEASURES

EYE CONTACT:

In case of eye contact, immediately flush with plenty of water for at least 15 minutes.

SKIN CONTACT:

In case of contact, immediately wash skin with plenty of soap and water for at least 15 minutes.

INGESTION:

If swallowed and the person is conscious, immediately give large amounts of water. Get medical attention.

INHALATION:

If a person breathers in large amounts, move the exposed person to fresh air.

NOTES TO PHYSICIAN: None

SECTION V: FIRE FIGHTING INFORMATION

Flashpoint (Degrees C) and Method: N/A
Auto ignition Temperature (Degrees C): N/A

FLAMMABLE LIMITS:

Components

Upper Explosive Limit

Lower Explosive Limit

Sodium Sulfate, Anhydrous

N/A

N/A

GENERAL HAZARD:

Unusual Fire and Explosion Hazards:

None Identified.

FIRE FIGHTING INSTRUCTIONS:

Use extinguishing media appropriate for surrounding fire.

FIRE FIGHTING EQUIPMENT:

Firefighters should wear proper protective equipment and self-contained breathing Apparatus with full facepiece operated in positive pressure mode.

EXTINGUISHING MEDIA:

Foam

Alcohol Foam

CO2

Dry Chemical

Water

Other

Sodium Sulfate

HAZARDOUS COMBUSTION PRODUCTS:
Combustion may release sulfur dioxide.

NATIONAL FIRE PROTECTION ASSOCIATION (NFPA):

NFPA Hazard Rating:	0 – Insignificant	1 – Slight	2 – Moderate
	3 - High	4 – Extreme	5 – Unknown
	*- No Information		

Health :0
Flammability :0
Reactivity :0

SPECIAL INFORMATION:

Contact Hazard:	Slight (1)
Explosion Data – Sensitivity to Mechanical Impact:	None Identified
Explosion Data - Sensitivity to Static Discharge:	None Identified

SECTION VI: ACCIDENTAL RELEASE MEASURES

LAND SPILL:

Wear suitable protective clothing. Sweep up and remove.

SECTION VII: HANDLING AND STORAGE

GENERAL STORAGE CONDITIONS:

Keep container tightly closed. Keep from contact with oxidizing materials. Isolate from incompatible materials.

Special Precautions: material is hygroscopic.

SECTION VIII: EXPOSURE CONTROLS/PERSONAL PROTECTION

ENGINEERING CONTROLS:

Use adequate general or local exhaust ventilation to keep fume or dust levels as low as possible.

PERSONAL PROTECTION:

RESPIRATOR:

None required where adequate ventilation conditions exist. If airborne concentration is high, use an appropriate respirator or dust mask.

PROTECTIVE CLOTHING:

Safety goggles, rubber gloves recommended.

SECTION VIII: PHYSICAL AND CHEMICAL PROPERTIES

Vapor Pressure (mmHg): N/A Solubility in Water: Appreciable
Specific Gravity (water=1): 2.68 pH: 6-10

Sodium Sulfate

Boiling Point (Degrees C): N/A Physical State: Sol.id
Freezing Point (Degrees C): 884 Vapor Density (air=1): N/A
Evaporation Rate (BuAc=1): N/A Percent Volatile by Volume:0
Viscosity: Odor: Odorless
Appearance: White crystals or powder

SECTION X: STABILITY AND REACTIVITY

GENERAL:

STABILITY:

Stable:

Unstable:

HAZARDOUS POLYMERIZATION:

Will Not Occur:

Will Occur:

INCOMPATIBLE MATERIALS:

Strong oxidizing agents.

CONDITIONS TO AVOID:

Moisture

HAZARDOUS DECOMPOSITION PRODUCTS:

Oxides of sulfur.

SECTION XI: TOXICOLOGICAL INFORMATION

GENERAL:

Sodium Sulfate, Anhydrous:

5989 mg/kg oral mouse LD50

Carcinogenicity: None identified

Reproductive Effects: None identified

CARCINOGENIC INFORMATION:

Component	CAS#	Weight%	IARC	NTP	OSHA	ACGIH	Other
Sodium Sulfate Anhydrous	7757-82-6	99-100	No	No	No	No	No

SECTION XII: ECOLOGICAL INFORMATION

Environmental Fate:

When released into the soil, this material is expected to leach into groundwater. This material is not expected to significantly bioaccumulate.

Environmental Toxicity:

This material is not expected to be toxic to aquatic life. The LC50/96-hour values for fish are over 100 mg/l. The EC50/48-hour values for daphnia are over 100 mg/l.

SECTION XIII: DISPOSAL CONSIDERATION

RCRA Hazard Class: None

METHOD OF DISPOSAL:

Sodium Sulfate

Dispose of in accordance with all applicable federal, state and local environmental regulations.

SECTION XIII: TRANSPORTATION INFORMATION

DOT (Department of Transportation)

Proper Shipping Name: Chemicals, n.o.s. (non-regulated)
Hazard Class: None
Identification Number: None / No UN Number assigned

SECTION XV: REGULATORY INFORMATION

TSCA (Toxic Substances Control Act):

In TSCA Inventory? Yes No

CERCLA (Comprehensive Environmental Response Compensation, and Liability Act):
Classified as a Hazardous Substance? Yes No

SARA TITLE III (Superfund Amendments and Reauthorization Act):

311/312 Hazard Categories:

Acute Chronic Flammability Pressure Reactivity None

313 Reportable Ingredients: None

CALIFORNIA PROPOSITION 65: Not Listed

SECTION XVI: OTHER INFORMATION

Saltex, LLC provides the information contained herein in good faith but makes no representation as to its comprehensiveness or accuracy. This document is intended only as a guide to the appropriate precautionary handling of the material by a properly trained person using this product. Individuals receiving the information must exercise their independent judgment in determining its appropriateness for a particular purpose.

SALTEX, LLC MAKES NO REPRESENTATIONS, OR WARRANTIES, EITHER EXPRESS OR IMPLIED, INCLUDING WITHOUT LIMITATION ANY WARRANTIES OF MERCHANTABILITY, OR FITNESS FOR A PARTICULAR PURPOSE WITH RESPECT TO THE INFORMATION SET FORTH HEREIN OR THE PRODUCT TO WHICH THE INFORMATION REFERS. ACCORDINGLY, SALTEX, LLC WILL NOT BE RESPONSIBLE FOR DAMAGES RESULTING FROM USE OF OR RELIANCE UPON THIS INFORMATION.

N/A: Not Available, Not Applicable

N/D: Not Determined

N/E: Not Established

Sodium Sulfate

Safety Data Sheet

Issue Date: 27-Jan-2012

Revision Date: 20-July-2015

Version 1

1. IDENTIFICATION

Product Identifier

Product Name Hydrated Lime

Other means of identification

SDS # WKM-002

Recommended use of the chemical and restrictions on use

Recommended Use Water Treatment, Flue Gas Desulfurization, pH Adjustment, Construction

Details of the supplier of the safety data sheet

Manufacturer Address

Mid-Ohio Valley Lime
16360 State Route Seven South
Marietta, OH 45750

Emergency Telephone Number

Company Phone Number 1-888-847-3090
Emergency Telephone (24 hr) INFOTRAC 1-352-323-3500 (International)
1-800-535-5053 (North America)

2. HAZARDS IDENTIFICATION

Appearance White or grayish-white solid powder

Physical State solid

Odor Odorless

Classification

Skin corrosion/irritation	Category 2
Serious eye damage/eye irritation	Category 1
Carcinogenicity	Category 1A
Specific Target Organ Toxicity – Single Exposure	Category 3

Signal Word

Danger

Hazard Statements

Causes severe skin burns and eye damage
May cause respiratory irritation
May cause cancer through inhalation



Precautionary Statements - Prevention

Obtain special instructions before use
 Do not handle until all safety precautions have been read and understood
 Use personal protective equipment as required
 Do not breathe dust
 Wash face, hands and any exposed skin thoroughly after handling

Precautionary Statements - Response

Immediately call a poison center or doctor/physician
 IF IN EYES: Rinse cautiously with water for several minutes. Remove contact lenses, if present and easy to do. Continue rinsing
 IF ON SKIN (or hair): Remove/Take off immediately all contaminated clothing. Rinse skin with water/shower
 Wash contaminated clothing before reuse
 IF INHALED: Remove victim to fresh air and keep at rest in a position comfortable for breathing
 IF SWALLOWED: Rinse mouth. Do NOT induce vomiting

Precautionary Statements - Storage

Store locked up

Precautionary Statements - Disposal

Dispose of contents/container to an approved waste disposal plant

3. COMPOSITION/INFORMATION ON INGREDIENTS

Chemical Name	CAS No	Weight-%
Calcium Hydroxide	1305-62-0	>85
Quartz	14808-60-7	<1

If Chemical Name/CAS No is "proprietary" and/or Weight-% is listed as a range, the specific chemical identity and/or percentage of composition has been withheld as a trade secret.

4. FIRST-AID MEASURES

First Aid Measures

General Advice	Immediately call a poison center or doctor/physician. Provide this SDS to medical personnel for treatment.
Eye Contact	IF IN EYES: Rinse generously with water for several minutes. Remove contact lenses, if present and easy to do. Pull back the eyelid to ensure that all lime dust has been washed out. Seek medical attention immediately. Do not rub eyes.
Skin Contact	IF ON SKIN (or hair): Remove/Take off immediately all contaminated clothing. Rinse skin with water/shower. Wash contaminated clothing before reuse.
Inhalation	IF INHALED: Remove victim to fresh air and keep at rest in a position comfortable for breathing.
Ingestion	IF SWALLOWED: Rinse mouth. Do NOT induce vomiting.

Most important symptoms and effects

Symptoms	Causes severe skin burns and eye damage. May cause cancer. Contact may aggravate disorders of the eyes, skin, gastrointestinal tract, and respiratory system.
-----------------	---------------------------------------------------------------------------------------------------------------------------------------------------------------

Indication of any immediate medical attention and special treatment needed

Notes to Physician	Treat symptomatically.
---------------------------	------------------------

5. FIRE-FIGHTING MEASURES

Suitable Extinguishing Media

Use dry chemical fire extinguisher.

Unsuitable Extinguishing Media Do not use water or halogenated compounds. Only use large amounts of water that can be used to deluge small quantities of this product.

Specific Hazards Arising from the Chemical

Hydrated Lime is not combustible or flammable. However, it reacts vigorously with acids, and may release heat sufficient to ignite combustible materials in specific instances. Hydrated Lime is not considered to be an explosion hazard, although reaction with acids or other incompatible materials may rupture containers. When Hydrated Lime becomes wet, it can be slippery and can result in a slip hazard.

Hazardous Combustion Products Smoke, fumes or vapors, and oxides of carbon.

Protective equipment and precautions for firefighters

Keep personnel away from and upwind of fire. Avoid skin contact or inhalation of dust. Wear full fire-fighting turn-out gear (full Bunker gear), and respiratory protection (self-contained breathing apparatus).

6. ACCIDENTAL RELEASE MEASURES

Personal precautions, protective equipment and emergency procedures

Personal Precautions Use personal protective equipment as required.

Other Information Spill Procedures: Do not use water on bulk materials spills. Use proper protective equipment. Use personal protective equipment (eyes, skin, and inhalation). Use copious amounts of water to dilute. Follow proper drainage and disposal procedure.
Small Spills: Do not clean up with compressed air. Store collected materials in sealed plastic or non-aluminum containers. Residue on surfaces may be water washed.
Large Spills: Evacuate area downwind of clean-up operations to minimize dust exposure. Store spilled materials in sealed plastic or non-aluminum containers.

Environmental Precautions See Section 12 for additional Ecological Information.

Methods and material for containment and cleaning up

Methods for Containment Minimize dust generation and prevent bulk release to sewers or waterways.

Methods for Clean-Up Residual amounts of material can be flushed with large amounts of water. Avoid dry sweeping. Equipment can be washed with either a mild vinegar and water solution, or detergent and water. Dispose according to federal, provincial/ state and local environmental regulations.

7. HANDLING AND STORAGE

Precautions for safe handling

Advice on Safe Handling Handle in accordance with good industrial hygiene and safety practice. Obtain special instructions before use. Do not handle until all safety precautions have been read and understood. Use personal protective equipment as required. Avoid generating airborne dust. Do not breathe dust. Wash face, hands, and any exposed skin thoroughly after handling. Wash contaminated clothing before reuse.

Conditions for safe storage, including any incompatibilities

Storage Conditions	Store in cool, dry, and well-ventilated locations. Keep in tightly closed containers. Do not store near acids or other incompatible materials. Keep away from moisture. Do not store or ship in aluminum containers.
Packaging Materials	Do not store or ship in aluminum containers.
Incompatible Materials	Acids; reactive fluoridated, brominated or phosphorous compounds; aluminum (may form hydrogen gas), reactive powdered metals; organic acid anhydrides; nitro-organic compounds; interhalogenated compounds.

8. EXPOSURE CONTROLS/PERSONAL PROTECTION

Exposure Guidelines

Chemical Name	ACGIH TLV	OSHA PEL	NIOSH IDLH
Calcium Hydroxide 1305-62-0	TWA: 5 mg/m ³	TWA: 15 mg/m ³ total dust TWA: 5 mg/m ³ respirable fraction (vacated) TWA: 5 mg/m ³ not in effect as a result of reconsideration	TWA: 5 mg/m ³
Quartz 14808-60-7	TWA: 0.025 mg/m ³ respirable fraction	(vacated) TWA: 0.1 mg/m ³ respirable dust : (30)/(%SiO ₂ + 2) mg/m ³ TWA total dust : (250)/(%SiO ₂ + 5) mppcf TWA respirable fraction : (10)/(%SiO ₂ + 2) mg/m ³ TWA respirable fraction	IDLH: 50 mg/m ³ respirable dust TWA: 0.05 mg/m ³ respirable dust

Appropriate engineering controls

Engineering Controls	Apply technical measures to comply with the occupational exposure limits. Use with local exhaust ventilation. Eye wash and safety showers should be immediately available.
-----------------------------	----------------------------------------------------------------------------------------------------------------------------------------------------------------------------

Individual protection measures, such as personal protective equipment

Eye/Face Protection	Eye protection (chemical goggles, safety glasses with side shields) should be worn where there is risk of airborne dust. Contact lenses should not be worn when working with this product.
Skin and Body Protection	Use appropriate gloves and footwear to prevent skin contact. Clothing should fully cover arms and legs. Should hydrated lime get inside clothing, gloves, or contact skin, remove the clothing and hydrated lime promptly.
Respiratory Protection	Use NIOSH/MSHA approved respirators if airborne concentration exceeds PEL.

General Hygiene Considerations Handle in accordance with good industrial hygiene and safety practice.

9. PHYSICAL AND CHEMICAL PROPERTIES

Information on basic physical and chemical properties

Physical State	solid	Odor	Odorless
Appearance	White or grayish-white liquid powder	Odor Threshold	Not established
Color	White or grayish-white		
Property	Values	Remarks • Method	
pH	12.4	@ 25 °C (77 °F)	
Melting Point/Freezing Point	580 °C / 1076 °F		
Boiling Point/Boiling Range	2850 °C / 5162 °F		
Flash Point	Not flammable		

Evaporation Rate	Similar to water
Flammability (Solid, Gas)	Not applicable- liquid
Upper Flammability Limits	Not flammable
Lower Flammability Limit	Not flammable
Vapor Pressure	Non volatile
Vapor Density	Non volatile
Specific Gravity	1.1-1.4
Water Solubility	Slightly soluble in water: .2% @ 0 °C. Soluble in acids, glycerin, and sugar solutions.
Solubility in other solvents	Soluble in acids, glycerol and sugar solutions
Partition Coefficient	Not determined
Auto-ignition Temperature	Not determined
Decomposition Temperature	Not determined
Kinematic Viscosity	Not determined
Dynamic Viscosity	Not determined
Explosive Properties	Not determined
Oxidizing Properties	Not determined
Molecular weight	74.093 g/mol

10. STABILITY AND REACTIVITY

Reactivity

Reacts with acids to form calcium salts while generating heat. Reacts with carbon dioxide in air to form calcium carbonate.

Chemical Stability

Stable under recommended storage conditions.

Possibility of Hazardous Reactions

None under normal processing.

Hazardous Polymerization Hazardous polymerization does not occur.

Conditions to Avoid

Incompatible Materials.

Incompatible Materials

Acids; reactive fluoridated, brominated or phosphorous compounds; aluminum (may form hydrogen gas), reactive powdered metals; organic acid anhydrides; nitro-organic compounds; interhalogenated compounds.

Hazardous Decomposition Products

Smoke, fumes or vapors, and oxides of carbon.

11. TOXICOLOGICAL INFORMATION

Information on likely routes of exposure

Product Information

Eye Contact	Causes serious eye damage.
Skin Contact	Causes severe skin burns.
Inhalation	Causes severe irritation of the respiratory system.
Ingestion	Causes severe irritation or burning of gastrointestinal tract if swallowed.

Component Information

Chemical Name	Oral LD50	Dermal LD50	Inhalation LC50
Calcium Hydroxide 1305-62-0	= 7340 mg/kg (Rat)	-	-
Quartz 14808-60-7	= 500 mg/kg (Rat)	-	-

Information on physical, chemical and toxicological effects

Symptoms Please see section 4 of this SDS for symptoms.

Delayed and immediate effects as well as chronic effects from short and long-term exposure

Carcinogenicity Hydrated Lime is not listed by MSHA, OSHA, or IARC as a carcinogen, but this product may contain trace amounts of crystalline silica, which has been classified by IARC as carcinogenic to humans when inhaled in the form of quartz crystobalite.

Chemical Name	ACGIH	IARC	NTP	OSHA
Quartz 14808-60-7	A2	Group 1	Known	X

Numerical measures of toxicity

The following toxicological characteristics apply:

LD50: 7,340 mg/kg (oral, rat)

LD50: 7,300 mg/kg (oral, mouse)

12. ECOLOGICAL INFORMATION

Ecotoxicity

The product is not classified as environmentally hazardous. However, this does not exclude the possibility that large or frequent spills can have a harmful or damaging effect on the environment.

Chemical Name	Algae/aquatic plants	Fish	Toxicity to microorganisms	Crustacea
Calcium Hydroxide 1305-62-0		160: 96 h Gambusia affinis mg/L LC50 static		

Persistence/Degradability

Not determined.

Bioaccumulation

Not determined.

Mobility

Not determined

Other Adverse Effects

Not determined

13. DISPOSAL CONSIDERATIONS

Waste Treatment Methods

Disposal of Wastes Disposal should be in accordance with applicable regional, national and local laws and regulations.

Contaminated Packaging Disposal should be in accordance with applicable regional, national and local laws and regulations.

California Hazardous Waste Status This product contains one or more substances that are listed with the State of California as a hazardous waste

Chemical Name	California Hazardous Waste Status
Calcium Hydroxide 1305-62-0	Corrosive

14. TRANSPORT INFORMATION

Note Please see current shipping paper for most up to date shipping information, including exemptions and special circumstances.

DOT Not regulated

IATA Not regulated

IMDG Not regulated

15. REGULATORY INFORMATION

International Inventories

Chemical Name	TSCA	DSL	NDSL	EINECS	ELINCS	ENCS	IECSC	KECL	PICCS	AICS
Calcium Hydroxide	Present	X		Present		Present	X	Present	X	X
Quartz	Present	X		Present		Present	X	Present	X	X

Legend:

TSCA - United States Toxic Substances Control Act Section 8(b) Inventory

DSL/NDSL - Canadian Domestic Substances List/Non-Domestic Substances List

EINECS/ELINCS - European Inventory of Existing Chemical Substances/European List of Notified Chemical Substances

ENCS - Japan Existing and New Chemical Substances

IECSC - China Inventory of Existing Chemical Substances

KECL - Korean Existing and Evaluated Chemical Substances

PICCS - Philippines Inventory of Chemicals and Chemical Substances

AICS - Australian Inventory of Chemical Substances

US Federal Regulations

SARA 313

Section 313 of Title III of the Superfund Amendments and Reauthorization Act of 1986 (SARA). This product does not contain any chemicals which are subject to the reporting requirements of the Act and Title 40 of the Code of Federal Regulations, Part 372

CWA (Clean Water Act)

This product does not contain any substances regulated as pollutants pursuant to the Clean Water Act (40 CFR 122.21 and 40 CFR 122.42)

US State Regulations

California Proposition 65

This product contains the following Proposition 65 chemicals.

Chemical Name	California Proposition 65
Quartz - 14808-60-7	Carcinogen

U.S. State Right-to-Know Regulations

Chemical Name	New Jersey	Massachusetts	Pennsylvania
Calcium Hydroxide 1305-62-0	X	X	X

Quartz 14808-60-7	X	X	X
----------------------	---	---	---

16. OTHER INFORMATION

<u>NFPA</u>	Health Hazards	Flammability	Instability	Special Hazards
	1	0	0	-
<u>HMIS</u>	Health Hazards	Flammability	Physical Hazards	Personal Protection
	2	0	0	E

Issue Date: 27-Jan-2012
 Revision Date: 13-Apr-2015
 Revision Note: New format

Disclaimer

The information provided in this Safety Data Sheet is correct to the best of our knowledge, information and belief at the date of its publication. The information given is designed only as a guidance for safe handling, use, processing, storage, transportation, disposal and release and is not to be considered a warranty or quality specification. The information relates only to the specific material designated and may not be valid for such material used in combination with any other materials or in any process, unless specified in the text.

End of Safety Data Sheet

SAFETY DATA SHEET

According to Federal Regulation 29 CFR 1910.1200

SECTION 1. Identification of the substance/mixture and of the company/undertaking

1.1. Product identifier

Product names: TRAMFLOC® 100 to 199 Series Anionic Emulsion polymers

Type of product: Mixture

1.2. Relevant identified uses of the substance or mixture and uses advised against

Identified uses: Processing aid for industrial applications.

Uses advised against: none

1.3. Details of the supplier of the safety data sheet

Company: Tramfloc, Inc.
6046 FM 2920 Rd. #615
Spring, TX 77379-2542
Telephone: 888-929-8973
Telefax: 480-383-6895
E-mail address: water@tramfloc.com

1.4 Emergency telephone number:

24-hour emergency number: 800-424-9300 CHEMTREC (CCN 20412), Outside US 703-527-3887

SECTION 2. Hazards identification

2.1. Classification of the substance or mixture

Classification according to paragraph (d) of Regulation 29 CFR 1910.1200:

Not classified.

2.2. Label elements

Labelling according to paragraph (f) of Regulation 29 CFR 1910.1200:

Hazard symbol(s): none
Signal word: none
Hazard statement(s): none
Precautionary statement(s): none

2.3. Other hazards

Aqueous solutions or powders that become wet render surfaces extremely slippery.

SECTION 3. Composition/information on ingredients

3.1 Substances

Not applicable, this product is not a substance.

3.2 Mixtures

Hazardous components

Distillates (petroleum), hydrotreated light

Concentration/ gamme : 20-45%

CAS Number: 64742-47-8

Classification according to paragraph

(d) of Regulation 29 CFR 1910.1200: Asp. Tox. 1: H304

Notes:

Does not result in classification of the mixture if the kinematic viscosity is greater than 20.5 mm²/s measured at 40°C.

Poly(oxy-1,2-ethanediyl), a-tridecyl-w-hydroxy-, branched

Concentration/ gamme : < 3%

CAS Number: 69011-36-5

Classification according to paragraph

(d) of Regulation 29 CFR 1910.1200: Acute Tox.4; H302, Eye Dam. 1; H318

For explanation of abbreviations see section 16

SECTION 4. First aid measures

4.1. Description of first aid measures

Inhalation:

Move to fresh air. No hazards which require special first aid measures.

Skin contact:

Wash off immediately with soap and plenty of water while removing all contaminated clothes and shoes. In case of persistent skin irritation, consult a physician.

Eye contact:

Rinse immediately with plenty of water, also under the eyelids, for at least 15 minutes. Alternatively, rinse immediately with Diphoterine®. Get prompt medical attention.

Ingestion:

Rinse mouth with water. Do NOT induce vomiting. Call a physician or poison control centre immediately.

4.2. Most important symptoms and effects, both acute and delayed

None under normal use.

4.3. Indication of any immediate medical attention and special treatment needed.

None reasonably foreseeable.

Other information:

None.

SECTION 5. Fire-fighting measures

5.1. Extinguishing media

Suitable extinguishing media:

Water. Water spray. Foam. Carbon dioxide (CO₂). Dry powder.

Unsuitable extinguishing media:

None.

5.2. Special hazards arising from the substance or mixture

Hazardous decomposition products:

Carbon oxides (CO_x). Nitrogen oxides (NO_x). Hydrogen cyanide (hydrocyanic acid) may be produced in the event of combustion in an oxygen deficient atmosphere.

5.3. Advice for fire-fighters

Protective measures:

Wear self-contained breathing apparatus and protective suit.

Other information:

Spills produce extremely slippery surfaces.

SECTION 6: Accidental release measures

6.1. Personal precautions, protective equipment and emergency procedures

Personal precautions:

Do not touch or walk through spilled material. Spills produce extremely slippery surfaces.

Protective equipment:

Wear suitable protective clothing, gloves and eye/face protection.

Emergency procedures:

Keep people away from spill/leak.

6.2. Environmental precautions

As with all chemical products, do not flush into surface water.

6.3. Methods and material for containment and cleaning up

Small spills:

Do not flush with water. Soak up with inert absorbent material. Sweep up and shovel into suitable containers for disposal.

Large spills:

Do not flush with water. Dam up. Clean up promptly by scoop or vacuum.

Residues:

Soak up with inert absorbent material. After cleaning, flush away traces with water.

6.4. Reference to other sections

SECTION 8: Exposure controls/personal protection; SECTION 13: Disposal considerations; SECTION 7: Handling and storage;

SECTION 7. Handling and storage

7.1. Precautions for safe handling

Avoid contact with skin and eyes. Renders surfaces extremely slippery when spilled. When using, do not eat, drink or smoke.

7.2. Conditions for safe storage, including any incompatibilities.

Keep away from heat and sources of ignition. Freezing will affect the physical condition and may damage the material. Incompatible with oxidizing agents.

7.3. Specific end use(s)

None.

SECTION 8. Exposure controls/personal protection

8.1. Control parameters

Occupational exposure limits:

Distillates (petroleum), hydrotreated light

ACGIH: 200 mg/m³ (8-hour)

8.2. Exposure controls

Appropriate engineering controls:

Use local exhaust if dusting occurs. Natural ventilation is adequate in absence of dusts.

Individual protection measures, such as personal protective equipment:

Eye/face protection: Safety glasses with side-shields.

Skin protection: Wear coveralls and/or chemical apron and rubber footwear where physical contact can occur.

Hand protection: PVC or other plastic material gloves.

Respiratory protection: No personal respiratory protective equipment normally required.

Additional advice: Wash hands before breaks and at the end of workday. Handle in accordance with good industrial hygiene and safety practice. Wash hands and face before breaks and immediately after handling the product.

Environmental exposure controls: Do not allow uncontrolled discharge of product into the environment.

SECTION 9. Physical and chemical properties

9.1. Information on basic physical and chemical properties

Appearance: Viscous liquid, Milky.

Odor: Aliphatic

Odor Threshold: Not applicable.

pH: 5 - 8 @ 5 g/L

Melting point/freezing point: > 5°C

Initial boiling point and boiling range: > 100°C

Flash point: Not applicable.

Evaporation rate:	Not applicable.
Flammability (solid, gas):	No data available.
Upper/lower flammability or explosive limits:	Not expected to create explosive atmospheres.
Vapour pressure:	2.3 kPa @ 20°C
Relative density:	1.0 – 1.2
Solubility(ies):	Completely miscible.
Partition coefficient:	Not applicable.
Autoignition temperature:	No data available.
Decomposition temperature:	> 150°C
Viscosity:	> 20.5 mm ² /s @ 40°C
Explosive properties:	Not expected to be explosive based on the chemical structure.
Oxidizing properties:	Not expected to be oxidizing based on the chemical structure.

9.2. Other information

None.

SECTION 10. Stability and reactivity

10.1. Reactivity

Stable under recommended storage conditions.

10.2. Chemical stability

Stable under recommended storage conditions.

10.3. Possibility of hazardous reactions

None known.

10.4. Conditions to avoid

Protect from frost, heat and sunlight.

10.5. Incompatible materials

Incompatible with oxidizing agents.

10.6. Hazardous decomposition products

Thermal decomposition may produce: nitrogen oxides (NO_x), carbon oxides (CO_x). Hydrogen cyanide (hydrocyanic acid) may be produced in the event of combustion in an oxygen deficient atmosphere.

SECTION 11. Toxicological information

11.1. Information on toxicological effects

Information on the product as supplied:

Acute oral toxicity:	LD50/oral/rat > 5000 mg/kg
Acute dermal toxicity:	LD50/dermal/rat > 5000 mg/kg
Acute inhalation toxicity:	The product is not expected to be toxic by inhalation.
Skin corrosion/irritation:	Not irritating.

Serious eye damage/eye irritation: Slightly irritating.

Respiratory/skin sensitization: Not sensitizing.

Mutagenicity: Not mutagenic.

Carcinogenicity: Not carcinogenic.

Reproductive toxicity: Not toxic for reproduction.

STOT - single exposure: No known effects.

STOT - repeated exposure: No known effects.

Aspiration hazard: Due to the viscosity, this product does not present an aspiration hazard.

Relevant information on the hazardous components:

Distillates (petroleum), hydrotreated light

Acute oral toxicity: LD50/oral/rat > 5000 mg/kg (OECD 401)

Acute dermal toxicity: LD50/dermal/rabbit > 5000 mg/kg (OECD 402)

Acute inhalation toxicity: LC50/inhalation/4 h/rat = 4951 mg/m³ (OECD 403)

Skin corrosion/irritation: Not irritating. (OECD 404)

Repeated exposure may cause skin dryness or cracking.

Serious eye damage/eye irritation: Not irritating. (OECD 405)

Respiratory/skin sensitisation: By analogy with similar products, this product is not expected to be sensitizing. (OECD 406)

Mutagenicity: Not mutagenic. (OECD 471, 473, 474, 476, 478, 479)

Carcinogenicity: Carcinogenicity study in rats (OECD 451): Negative

Reproductive toxicity: By analogy with similar substances, this substance is not expected to be toxic for reproduction. NOAEL/rat = 300 ppm (OECD 421)

STOT - single exposure: No known effects.

STOT - repeated exposure: NOAEL/oral/rat/90 days >= 3000 mg/kg/day (OECD 408) (Based on results obtained from tests on analogous products.).

Aspiration hazard: May be fatal if swallowed and enters airways.

Poly(oxy-1,2-ethanediyl), n-tridecyl-w-hydroxy-, branched

Acute oral toxicity: LD50/oral/rat = 200 - 300 mg/kg

Acute dermal toxicity: LD50/dermal/rabbit > 2000 mg/kg

Acute inhalation toxicity: No data available.

Skin corrosion/irritation: Not irritating.

Serious eye damage/eye irritation: Causes serious eye irritation.

Respiratory/skin sensitisation: The results of testing on guinea pigs showed this material to be non-sensitizing.

Mutagenicity: Not mutagenic.

Carcinogenicity: Not carcinogenic.

Reproductive toxicity: Two-Generation Reproduction Toxicity (OECD 416)
NOAEL/rat > 250 mg/kg/day
Prenatal Development Toxicity Study (OECD 414)
NOAEL/Maternal toxicity/rat > 50 mg/kg/day
NOAEL/Developmental toxicity/rat > 50 mg/kg/day

STOT - single exposure: No known effects.

STOT - repeated exposure: NOAEL/oral/rat/600 days = 50 mg/kg/day

Aspiration hazard: No known effects.

SECTION 12. Ecological information

12.1. Toxicity

Information on the product as supplied:

Acute toxicity to fish: LC50/Fish/96 hours > 100 mg/L

Acute toxicity to invertebrates: EC50/Daphnia/48 hours > 100 mg/L

Acute toxicity to algae: IC50/Algae/72 hours > 100 mg/L

Chronic toxicity to fish: No data available.

Chronic toxicity to invertebrates: No data available.

Toxicity to microorganisms: No data available.

Effects on terrestrial organisms: No data available.

Sediment toxicity: No data available.

Relevant information on the hazardous components:

Distillates (petroleum), hydrotreated light

Acute toxicity to fish: LC0/Oncorhynchus mykiss/96 hours > 1000 mg/L (OECD 203)

Acute toxicity to invertebrates: EC0/Daphnia magna/48 hours > 1000 mg/L (OECD 202)

Acute toxicity to algae: IC0/Pseudokirchneriella subcapitata/72 hours > 1000 mg/L (OECD 201)

Chronic toxicity to fish: NOEC/Oncorhynchus mykiss/28 days > 1000 mg/L

Chronic toxicity to invertebrates: NOEC/Daphnia magna/21 days > 1000 mg/L

Toxicity to microorganisms: EC50/Tetrahymena pyriformis/ 48h > 1000 mg/L

Effects on terrestrial organisms: No data available.

Sediment toxicity: No data available. Readily biodegradable, exposure to sediment is unlikely.

Poly(oxy-1,2-ethanediyl), a-tridecyl-w-hydroxy-, branched

Acute toxicity to fish: LC50/Cyprinus carpio/96 hours = 1 - 10 mg/L (OECD 203)

Acute toxicity to invertebrates: EC50/Daphnia/48 hours = 1 - 10 mg/L (OECD 202)

Acute toxicity to algae: IC50/Desmodesmus subspicatus/72 hours = 1 - 10 mg/L (OECD 201)

Chronic toxicity to fish: No data available.

Chronic toxicity to invertebrates: No data available.

Toxicity to microorganisms: EC10/activated sludge/17 h > 10000 mg/L (DIN 38412-8)

Effects on terrestrial organisms: No data available.

Sediment toxicity: No data available.

12.2. Persistence and degradability

Information on the product as supplied:

Degradation: Not readily biodegradable.

Hydrolysis: Does not hydrolyze.

Photolysis: No data available.

Relevant information on the hazardous components:

Distillates (petroleum), hydrotreated light

Degradation: Readily biodegradable.

Hydrolysis: Does not hydrolyse.

Photolysis: No data available.

Poly(oxy-1,2-ethanediyl), a-tridecyl-w-hydroxy-, branched

Degradation: Readily biodegradable. > 60% / 28 days (OECD 301 B)

Hydrolysis: Does not hydrolyse.

Photolysis: No data available.

12.3. Bioaccumulative potential

Information on the product as supplied:

Not bioaccumulating.

Partition co-efficient (Log Pow): -2

Bioconcentration factor (BCF): ~0

Relevant information on the hazardous components:

Distillates (petroleum), hydrotreated light

Partition co-efficient (Log Pow): 3-6

Bioconcentration factor (BCF): No data available.

Poly(oxy-1,2-ethanediyl), a-tridecyl-w-hydroxy-, branched

Partition co-efficient (Log Pow): > 3

Bioconcentration factor (BCF): No data available.

12.4. Mobility in soil

Information on the product as supplied:

No data available.

Relevant information on the hazardous components:

Distillates (petroleum), hydrotreated light

Koc: No data available.

Poly(oxy-1,2-ethanediyl), a-tridecyl-w-hydroxy-, branched

Koc: > 5000 12.5. Other adverse effects

None.

12.5. Other adverse effects

None known.

SECTION 13. Disposal considerations

13.1. Waste treatment methods

Waste from residues / unused products:

Dispose of in accordance with local regulations.

Contaminated packaging:

If recycling is not practicable, dispose of in compliance with local regulations.

Recycling:

The product and its packaging are not suitable for recycling.

SECTION 14. Transport information

Land transport (DOT)

Not classified.

Sea transport (IMDG)

Not classified.

Air transport (IATA)

Not classified.

SECTION 15. Regulatory information

15.1. Safety, health and environmental regulations/legislation specific for the substance or mixture

Information on the product as supplied: TSCA Chemical Substances Inventory:

All components of this product are either listed on the inventory or are exempt from listing.

US SARA Reporting Requirements: SARA (Section 311/312) hazard class:

Not concerned.

RCRA status :

Not RCRA hazardous.

California Proposition 65 Information:

WARNING! This product contains a chemical known to the State of California to cause cancer and birth defects or other reproductive harm, acrylamide.

SECTION 16. Other information

NFPA and HMIS Ratings: NFPA:

Health: 0

Flammability: 1

Instability: 0



HMIS:

Health: 0

Flammability: 1

Physical Hazard: 0

PPE Code: B

This data sheet contains changes from the previous version in section(s):

SECTION 1. Identification of the substance/mixture and of the company/undertaking, SECTION 2. Hazards identification, SECTION 3. Composition/information on ingredients, SECTION 4. First aid measures, SECTION 5. Fire-fighting measures, SECTION 6. Accidental release measures, SECTION 7. Handling and storage, SECTION 8. Exposure controls/personal protection, SECTION 9. Physical and chemical properties, SECTION 10. Stability and reactivity, SECTION 11. Toxicological information, SECTION 12. Ecological information, SECTION 13. Disposal considerations, SECTION 14. Transport information, SECTION 15. Regulatory information, SECTION 16. Other Information.

Key or legend to abbreviations and acronyms used in the safety data sheet:

Abbreviations

Acute Tox. 4 = Acute toxicity Category Code 4

Asp. Tox. 1 = Aspiration hazard Category Code 1

Eye Dam 1 = Serious eye damage/eye irritation Category Code 1

H-Phrases

H302 - Harmful if swallowed

H304 - May be fatal if swallowed and enters airways

H318 - Causes serious eye damage

This SDS was prepared in accordance with the following:

Federal Regulation 29 CFR 1910.1200

The information contained herein is to the best of our knowledge and belief accurate. However, since the conditions of handling and use are beyond our control, Tramfloc, Inc. makes no guarantee for results obtained, and assumes no responsibility for damages incurred by use of this product. It is the responsibility of the user to comply with all federal, state, and local laws and regulations.

MATERIAL SAFETY DATA SHEET

PRETREATED BRINE

FILE NO.:
MSDS DATE: 10/8/2015

SECTION 1: PRODUCT AND COMPANY IDENTIFICATION

PRODUCT NAME: PRETREATED BRINE
SYNONYMS: BRINE SOLUTION, PRODUCED WATER, FORMATION WATER, FRACTIONATION WATER
PRODUCT CODES: N/A

MANUFACTURER: FAIRMONT BRINE PROCESSING, LLC
DIVISION: N/A
ADDRESS: 168 AFR DRIVE | FAIRMONT, WV 26554

EMERGENCY PHONE: (412) 680-6244
CHEMTREC PHONE: (800) 424-9300 (24 HOURS)
OTHER CALLS: (304) 363-9876
FAX PHONE: (412) 231-5891

CHEMICAL NAME: BRINE SOLUTION
CHEMICAL FAMILY: MIXTURE
CHEMICAL FORMULA: MIXTURE

PRODUCT USE: EVAPORATION/ CRYSTALLIZATION
PREPARED BY: LDK

SECTION 1 NOTES: Discharge from pretreatment process (after oil removal, chemical precipitation, clarification, and filtration)

SECTION 2: COMPOSITION/INFORMATION ON INGREDIENTS

<u>INGREDIENT</u>	<u>CAS NO.</u>	<u>% WT</u>
Water	7732-18-5	80-95
Calcium chloride	10043-52-4	0-10
Potassium chloride	7447-40-7	0-10
Sodium chloride	7647-14-5	0-10
Residual metals	Various	<1
Benzene	71-43-2	<0.01

SECTION 3: HAZARDS IDENTIFICATION

EMERGENCY OVERVIEW: WARNING! Causes eye irritation. The product may contain benzene which may cause cancer and cause blood disorders.

ROUTES OF ENTRY: Eye contact. Skin contact. Ingestion. Inhalation.

POTENTIAL HEALTH EFFECTS

EYES: Causes eye irritation

SKIN: Prolonged or repeated skin contact may cause irritation.

INGESTION: May cause gastrointestinal irritation, nausea, vomiting and diarrhea

INHALATION: No inhalation hazard under normal conditions. If misting occurs: may cause mild mucous membrane irritation of the nose, throat, and upper respiratory tract.

ACUTE HEALTH HAZARDS: Causes eye irritation.

CHRONIC HEALTH HAZARDS: May contain benzene. Human epidemiology studies indicate that prolonged and/or repeated overexposure to benzene may cause damage to the blood-producing system and serious blood disorders, including leukemia. Animal tests suggest that prolonged and/or repeated overexposure to benzene may damage the embryo/fetus. The relevance of these animal studies to humans has not been fully established.

CARCINOGENICITY

This product is not considered to be a carcinogen by IARC, ACGIH, NTP, or OSHA.

OSHA:	Benzene (CAS 71-43-2)	Cancer hazard
ACGIH:	Benzene (CAS 71-43-2)	A1 Confirmed human carcinogen
NTP:	Benzene (CAS 71-43-2)	Known carcinogen
IARC:	Benzene (CAS 71-43-2)	1 Carcinogenic to humans

MATERIAL SAFETY DATA SHEET

PRETREATED BRINE

FILE NO.:
MSDS DATE: 10/8/2015

SECTION 4: FIRST AID MEASURES

EYES: In case of contact, immediately flush eyes with fresh water for at least 15 minutes while holding the eyelids open. Remove contact lenses if worn. Get medical attention if irritation persists.

SKIN: Remove contaminated clothing and shoes. Wash affected area with mild soap and water. Get medical attention if irritation develops and persists.

INGESTION: Rinse mouth thoroughly. Get medical attention if any discomfort occurs

INHALATION: If breathing is difficult, remove to fresh air and keep at rest in a position comfortable for breathing. Call a physician if symptoms develop or persist.

SECTION 4 NOTES: If you feel unwell, seek medical advice (show the label where possible). Ensure that medical personnel are aware of the material(s) involved, and take precautions to protect themselves.

SECTION 5: FIRE-FIGHTING MEASURES

FLAMMABLE PROPERTIES: This product is not flammable; however sufficient hydrocarbon vapors may accumulate from oil or natural gas condensate floating on the surface of the produced water to cause a flash fire. The fire should burn out fairly rapidly depending on the amount of oil and natural gas condensate floating on the surface of the produced water.

EXTINGUISHING MEDIA

SUITABLE EXTINGUISHING MEDIA: Dry chemical powder. Foam. Carbon dioxide (CO₂).

PROTECTION OF FIREFIGHTERS

PROTECTIVE EQUIPMENT AND PRECAUTIONS FOR FIREFIGHTERS: A fire would be associated with vapors related to oil or natural gas condensate floating on the surface of the produced water. Water maybe ineffective on flames and may even spread the fire but should be used to cool pressurized containers in the fire.

SPECIAL PROTECTIVE EQUIPMENT FOR FIREFIGHTERS:

Firefighters should wear appropriate protective equipment and self-contained breathing apparatus (SCBA) with full face-piece operated in positive pressure mode. Use approved gas detectors in confined spaces.

SPECIFIC METHODS: Promptly isolate the scene by removing persons from the vicinity of the incident if there is a fire. Do not extinguish flames at leak because of the possibility of a uncontrolled re-ignition exists. If it is safe to do so, cut off fuel supply and/or allow fire to burn out. The fire should burn out fairly rapidly depending on the amount of oil and natural gas condensate floating on the surface of the produced water. If leak or spill has not ignited, water spray or ventilation can be used to disperse the vapors.

HAZARDOUS COMBUSTION PRODUCTS: Sodium oxides. Carbon oxides.

SECTION 6: ACCIDENTAL RELEASE MEASURES

ACCIDENTAL RELEASE MEASURES: Recover by pumping (use an explosion-proof motor or hand pump) or by sand or other oil absorbing materials. Carefully shovel, scoop or sweep up into a waste container for reclamation or disposal. Where feasible and appropriate, remove contaminated soil or flush with fresh water. On water spills utilize absorbent material to remove oil and natural gas liquid from the surface of the water.

SECTION 6 NOTES: Avoid excess skin contact with spilled material.

SECTION 7: HANDLING AND STORAGE

HANDLING: Avoid contact with skin, eyes and clothing. Wash thoroughly after handling.

STORAGE: Keep containers in well-ventilated area away from flame, sparks, excessive temperatures and open flames. Keep the containers closed and clearly labeled. Empty product containers or vessels may contain vapors. Do not pressurize, cut, heat, weld or expose such containers to sources of ignition. Do not enter storage areas and confined spaces without adequate ventilation. Use appropriate respiratory protection if there is the potential to exceed the exposure limit(s). Vapors containing benzene may accumulate during storage and transport.

SECTION 8: EXPOSURE CONTROLS/PERSONAL PROTECTION

VENTILATION: Ensure adequate ventilation, especially in confined areas.

RESPIRATORY PROTECTION: No personal respiratory equipment normally required.

EYE PROTECTION: If eye contact is likely, safety glasses should be worn.

MATERIAL SAFETY DATA SHEET
PRETREATED BRINE

FILE NO.:
MSDS DATE: 10/8/2015

SECTION 8: EXPOSURE CONTROLS/PERSONAL PROTECTION (Continued)

SKIN PROTECTION: No special garments required. Wash contaminated clothing prior to reuse.

OTHER PROTECTIVE CLOTHING OR EQUIPMENT: No other protective clothing or equipment is needed.

WORK HYGIENIC PRACTICES: Always observe good personal hygiene measures, such as washing after handling the material and before eating, drinking, and/or smoking. Routinely wash work clothing and protective equipment to remove contaminants. Discard contaminated clothing and footwear that cannot be cleaned. Handle in accordance with good industrial hygiene and safety practice.

SECTION 9: PHYSICAL AND CHEMICAL PROPERTIES

APPEARANCE: Dirty colored liquid

ODOR: Faint hydrocarbon odor

PHYSICAL STATE: Liquid

pH AS SUPPLIED: 4.5-7.5
pH (Other):

BOILING POINT:

F: 212°
C: 100°

MELTING POINT:

F: N/A
C: N/A

FREEZING POINT:

F: < 32°
C: < 0°

VAPOR PRESSURE (mmHg): 13.6 (approx.)

@ F: 68°
C: 20°

VAPOR DENSITY (AIR = 1): <1

@ F: 68°
C: 20°

SPECIFIC GRAVITY (H₂O = 1): 1.2 (approx.)

@ F: 68°
C: 20°

EVAPORATION RATE: N/A

SOLUBILITY IN WATER: Complete

PERCENT SOLIDS BY WEIGHT: N/A

PERCENT VOLATILE: N/A

BY WT/ BY VOL @

F:
C:

VOLATILE ORGANIC COMPOUNDS (VOC): N/A

WITH WATER: LBS/GAL

WITHOUT WATER: LBS/GAL

MOLECULAR WEIGHT: N/A

SECTION 10: STABILITY AND REACTIVITY

STABILITY: Stable

CONDITIONS TO AVOID (STABILITY): Keep away from heat, sparks, and open flame.

HAZARDOUS DECOMPOSITION OR BY-PRODUCTS: Carbon dioxide. Water vapor. May produce oxides of sulfur. Carbon monoxide via incomplete combustion.

HAZARDOUS POLYMERIZATION: Does not occur.

CONDITIONS TO AVOID (POLYMERIZATION): N/A

MATERIAL SAFETY DATA SHEET

PRETREATED BRINE

FILE NO.:
MSDS DATE: 10/8/2015

SECTION 11: TOXICOLOGICAL INFORMATION

TOXICOLOGICAL INFORMATION: This product may contain detectable but varying quantities of the naturally occurring radioactive substance Radium 226/228. Due to the long half life of Radium 226/228 (1600yr/5.75yr), there should not be significant radiation. The solution may cause eye and skin irritation.

SECTION 12: ECOLOGICAL INFORMATION

ECOLOGICAL INFORMATION: An environmental hazard cannot be excluded in the event of unprofessional handling or disposal.

SECTION 12 NOTES: To be expected to be harmful to aquatic organisms.

SECTION 13: DISPOSAL CONSIDERATIONS

WASTE DISPOSAL METHOD: Reuse or recycle if possible. All disposal practices must be in compliance with all Federal, State/Provincial and local laws and regulations. Regulations may vary in different locations. Waste characterizations and compliance with applicable laws are the responsibility solely of the waste generator. AS YOUR SUPPLIER, WE HAVE NO CONTROL OVER THE MANAGEMENT PRACTICES OR MANUFACTURING PROCESSES OF PARTIES HANDLING OR USING THIS MATERIAL. THE INFORMATION PRESENTED HERE PERTAINS ONLY TO THE PRODUCT AS SHIPPED IN ITS INTENDED CONDITION AS DESCRIBED IN MSDS SECTION: Composition Information. FOR UNUSED & UNCONTAMINATED PRODUCT, the preferred options include sending to a licensed, permitted: Reclaimer. Waste water treatment system.

SECTION 14: TRANSPORT INFORMATION

U.S. DOT 49 CFR 172.101:

Status: Not regulated

CANADIAN TRANSPORTATION OF DANGEROUS GOODS:

Status: Not regulated

OTHER AGENCIES:

SECTION 15: REGULATORY INFORMATION

U.S. REGULATIONS

OSHA REGULATORY STATUS: This material is considered hazardous by the OSHA Hazard Communication Standard (29 CFR 1910.1200)

CERCLA SECTIONS 102a/103 HAZARDOUS SUBSTANCES (40 CFR 302.4): Not regulated.

EPCRA EXTREMELY HAZARDOUS SUBSTANCES (40 CFR 355.30): Not regulated.

EPCRA SECTIONS 311/312 HAZARD CATEGORIES (40 CFR 370.10): Acute Health Hazard

EPCRA SECTION 313 (40 CFR 372.65): To the best of our knowledge, this product does not contain chemicals at levels which require reporting under this statute.

OSHA PROCESS SAFETY (PSM) (29 CFR 1910.119): Not regulated.

STATE REGULATIONS:

INTERNATIONAL REGULATIONS:

SECTION 16: OTHER INFORMATION

IMPORTANT:

The information presented herein, while not guaranteed, was prepared by technical personnel and is true and accurate to the best of our knowledge. **NO WARRANTY OF MERCHANTABILITY OR OF FITNESS FOR A PARTICULAR PURPOSE, OR WARRANTY OR GUARANTY OF ANY OTHER KIND, EXPRESS OR IMPLIED, IS MADE REGARDING PERFORMANCE, SAFETY, SUITABILITY, STABILITY OR OTHERWISE.** This information is not intended to be all-inclusive as to the manner and conditions of use, handling, storage, disposal and other factors that may involve other or additional legal, environmental, safety or performance considerations, and OxyChem assumes no liability whatsoever for the use of or reliance upon this information. While our technical personnel will be happy to respond to questions, safe handling and use of the product remains the responsibility of the customer. No suggestions for use are intended as, and nothing herein shall be construed as, a recommendation to infringe any existing patents or to violate any Federal, State, local or foreign laws. OSHA Standard 29 CFR 1910.1200 requires that information be provided to employees regarding the hazards of chemicals by means of a hazard communication program including labeling, safety data sheets, training and access to written records. We request that you, and it is your legal duty to, make all information in this Safety Data Sheet available to your employees.



SAFETY DATA SHEET

Page 1 of 4
Revision Date: 05/26/15

1. IDENTIFICATION

Product Name: **HW 7**

Company: **Henwil Corporation**
P.O. Box 358
Newell, PA 15466
Phone: 724-938-3610 Fax: 724-938-3639

Emergency telephone number: 724-938-3610

Product Use: Silicone-based defoamer

2. HAZARDS IDENTIFICATION



Warning! May cause eye irritation. Prolonged or repeated contact with the undiluted product can cause skin dryness or irritation. Swallowing this product may cause gastrointestinal irritation, diarrhea, nausea, and vomiting.

Precautions – Do not eat, drink or smoke when using this product. Avoid contact with eyes, skin and clothing. Wear protective rubber gloves, safety goggles and protective clothing when handling. Use in well-ventilated area. Avoid breathing mist or vapor. Wash thoroughly after handling. Keep containers closed when not in use.

HMIS & NFPA Ratings:	<u>HMIS</u>	<u>NFPA</u>
Health:	0	-
Flammability:	0	-
Reactivity:	0	-
Additional information:	B	

Product Name:

HW 7

Revision Date: 05/26/2015

EFFECTS OF OVEREXPOSURE

ACUTE OVEREXPOSURE: Possible skin and eye irritation.

CHRONIC OVEREXPOSURE: None known

3. COMPOSITION / INFORMATION ON INGREDIENTS

INGREDIENTS	CAS NO.	WEIGHT%	PEL	TLV
None	-	-	-	-

Listed carcinogen by: IARC: no NTP: no OSHA: no ACGIH: no

Legend: PEL: OSHA Permissible Exposure Limit TLV: ACGIH Threshold Limit
 TD: Total dust RF: Respirable fraction
 TWA: Time Weighted Average, 8-hr NTES: None Established

4. FIRST-AID MEASURES

EYES: Immediately flush with plenty of water for at least 15 minutes, holding eyelids apart to ensure flushing of the entire surface. Washing within one minute is essential to achieve maximum effectiveness. Seek medical attention.

SKIN: Wash thoroughly with soap and water, remove contaminated clothing and footwear. Wash clothing before reuse. Get medical attention immediately.

INHALATION: Remove victim from contaminated area to fresh air immediately. Get immediate medical attention. If breathing is difficult, give oxygen. Avoid mouth-to-mouth resuscitation.

INGESTION: NA

5. FIRE-FIGHTING MEASURES

FLASH POINT: > 200 °F (TCC)

AUTOIGNITION TEMPERATURE: NA

LOWER FLAMMABILITY LIMIT: NA

UPPER FLAMMABILITY LIMIT: NA

EXTINGUISHING MEDIA: Product will not burn until water is driven off; however, use extinguishing media as appropriate for the materials in the surrounding fire. On large fires, use dry chemical, foam, or water spray

FIRE FIGHTING PROCEDURES: Water spray should be used to keep drums cool if they are involved in a fire since heat will cause the product to expand and possibly cause the drums to explode from internal pressure.

Product Name: HW 7Revision Date: 05/26/2015**6. ACCIDENTAL RELEASE MEASURES**

Contain spill and salvage as much material as possible by pumping to a salvage tank or drum. Pick up remaining material with a suitable absorbent.

7. HANDLING AND STORAGE

Store at normal temperatures and conditions of warehousing. Keep container closed when not in use. Avoid allowing product to freeze. Wash contaminated clothing before re-wearing.

8. EXPOSURE CONTROLS / PERSONAL PROTECTION

COMPONENT	OSHA PEL	ACGIH TLV
None	-	-

VENTILATION REQUIREMENTS: Local exhaust, general mechanical.

EYE PROTECTION: Chemical splash goggles and/or face shield

SKIN PROTECTION: Wear appropriate personal protective clothing, including rubber gloves, to prevent skin contact

RESPIRATORY PROTECTION: Not normally required

OTHER REQUIRED EQUIPMENT: Standard work clothing and work shoes. Safety shower and eye wash located in immediate area

9. PHYSICAL AND CHEMICAL PROPERTIES

Appearance:	Milky white, liquid emulsion
Odor:	Slight
Odor threshold:	NA
Upper/lower flammability or explosive limits:	NA
Boiling point:	212° F
Melting point/freezing point	NA
Flammability (solid, gas):	NA
Flash point:	NA
Vapor pressure:	NA
Solubility in water:	Translucent emulsion
Vapor density (air = 1):	NA
Specific gravity (water):	0.95 – 1.05
Evaporation rate:	NA
pH:	6 - 8 (neat)
Partition coefficient (n-octanol/water):	NA
Autoignition temperature:	NA
Decomposition temperature:	NA
Viscosity:	< 100 cps

Product Name:

HW 7

Revision Date: 05/26/2015

10. STABILITY AND REACTIVITY

STABLE:	Yes. Acids will cause product to become very low in viscosity which will result in separation of the product.
HAZARDOUS POLYMERIZATION:	No
CONDITIONS TO AVOID:	NA
INCOMPATIBLE MATERIALS:	Strong oxidizers. Acids will cause product to become very low in viscosity which will result in separation of the product.
DECOMPOSITION PRODUCTS:	Carbon dioxide, carbon monoxide, and various hydrocarbons may be released during a fire.

11. TOXICOLOGICAL INFORMATION

PRINCIPAL ROUTES OF EXPOSURE: Skin, eyes and respiratory tract.

Ingestion: May cause gastrointestinal irritation, nausea, vomiting and diarrhea.

Inhalation: NA

Skin Contact: Prolonged or repeated contact with the undiluted product can cause skin dryness or irritation.

Eye Contact: Product is expected to cause eye irritation.

CARCINOGENICITY STATUS: Product does not contain any components in concentrations greater than or equal to 0.1% that are listed as known or suspected carcinogens by NTP, IARC, ACGIH or OSHA.

MUTAGENICITY/GENOTOXICITY/TERATOGENICITY: NA

ACUTE TOXICITY: NA

12. ECOLOGICAL INFORMATION

Acute Toxicity

Toxicity to fish:	N / A
Toxicity to daphnia:	LC ₅₀ / Daphnia (Ceriodaphnia dubia) / 48hr = 1649.4 mg / L
Toxicity to algae:	N / A

13. DISPOSAL CONSIDERATIONS

Dispose in accordance with all applicable federal, state and local regulations. Empty containers should be taken for local recycling, recovery or waste disposal.

14. TRANSPORT INFORMATION

Not subject to DOT, IMDG, IATA regulations

Product Name: HW 7Revision Date: 05/26/2015

15. REGULATORY INFORMATION

NA

16. OTHER INFORMATION

Person to contact: Product Manager

Legend:

NA = Not available

NAPL: Not Applicable

NTES = None Established

The information provided in this Safety Data Sheet is correct to the best of our knowledge, information and belief at the date of its publication. The information given is designed only as a guide for safe handling, use, processing, storage, transportation, disposal and release, and is not to be considered a warranty or quality specification. The information relates only to the specific material designated and may not be valid for such material used in combination with any other materials or in any process unless specified in the text

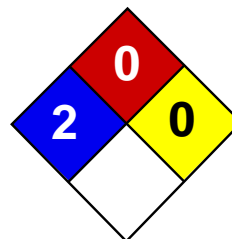

Health	2
Fire	0
Reactivity	0
Personal Protection	

Material Safety Data Sheet

Sodium Hydroxide, 25% MSDS

Section 1: Chemical Product and Company Identification

Product Name: Sodium Hydroxide, 25%

Catalog Codes: SLS4210

CAS#: Mixture.

RTECS: Not applicable.

TSCA: TSCA 8(b) inventory: Sodium hydroxide; Water

CI#: Not applicable.

Synonym:

Chemical Name: Not applicable.

Chemical Formula: Not applicable.

Contact Information:

Sciencelab.com, Inc.

14025 Smith Rd.

Houston, Texas 77396

US Sales: **1-800-901-7247**

International Sales: **1-281-441-4400**

Order Online: ScienceLab.com

CHEMTREC (24HR Emergency Telephone), call:

1-800-424-9300

International CHEMTREC, call: 1-703-527-3887

For non-emergency assistance, call: 1-281-441-4400

Section 2: Composition and Information on Ingredients

Composition:

Name	CAS #	% by Weight
Sodium hydroxide	1310-73-2	25
Water	7732-18-5	75

Toxicological Data on Ingredients: Sodium hydroxide LD50: Not available. LC50: Not available.

Section 3: Hazards Identification

Potential Acute Health Effects:

Very hazardous in case of skin contact (corrosive, irritant), of eye contact (irritant), of ingestion. Hazardous in case of inhalation. Liquid or spray mist may produce tissue damage particularly on mucous membranes of eyes, mouth and respiratory tract. Skin contact may produce burns. Inhalation of the spray mist may produce severe irritation of respiratory tract, characterized by coughing, choking, or shortness of breath. Inflammation of the eye is characterized by redness, watering, and itching. Skin inflammation is characterized by itching, scaling, reddening, or, occasionally, blistering.

Potential Chronic Health Effects:

Non-corrosive for skin. Non-irritant for skin. Non-sensitizer for skin. Non-permeator by skin. Non-irritating to the eyes. Non-hazardous in case of ingestion. Non-hazardous in case of inhalation. CARCINOGENIC EFFECTS: Not available. MUTAGENIC EFFECTS: Not available. TERATOGENIC EFFECTS: Not available. DEVELOPMENTAL TOXICITY: Not available. The substance is toxic to lungs, mucous membranes. Repeated or prolonged exposure to the substance can produce target organs damage. Repeated or prolonged contact with spray mist may produce chronic eye irritation and severe

skin irritation. Repeated or prolonged exposure to spray mist may produce respiratory tract irritation leading to frequent attacks of bronchial infection.

Section 4: First Aid Measures

Eye Contact:

Check for and remove any contact lenses. Immediately flush eyes with running water for at least 15 minutes, keeping eyelids open. Finish by rinsing thoroughly with running water to avoid a possible infection. Cold water may be used.

Skin Contact:

If the chemical got onto the clothed portion of the body, remove the contaminated clothes as quickly as possible, protecting your own hands and body. Place the victim under a deluge shower. If the chemical got on the victim's exposed skin, such as the hands : Gently and thoroughly wash the contaminated skin with running water and non-abrasive soap. Be particularly careful to clean folds, crevices, creases and groin. Cold water may be used. If irritation persists, seek medical attention. Wash contaminated clothing before reusing.

Serious Skin Contact:

Wash with a disinfectant soap and cover the contaminated skin with an anti-bacterial cream. Seek medical attention.

Inhalation: Allow the victim to rest in a well ventilated area. Seek immediate medical attention.

Serious Inhalation:

Evacuate the victim to a safe area as soon as possible. Loosen tight clothing such as a collar, tie, belt or waistband. If breathing is difficult, administer oxygen. If the victim is not breathing, perform mouth-to-mouth resuscitation. **WARNING:** It may be hazardous to the person providing aid to give mouth-to-mouth resuscitation when the inhaled material is toxic, infectious or corrosive. Seek immediate medical attention.

Ingestion:

Do not induce vomiting. Loosen tight clothing such as a collar, tie, belt or waistband. If the victim is not breathing, perform mouth-to-mouth resuscitation. Seek immediate medical attention.

Serious Ingestion: Not available.

Section 5: Fire and Explosion Data

Flammability of the Product: Non-flammable.

Auto-Ignition Temperature: Not applicable.

Flash Points: Not applicable.

Flammable Limits: Not applicable.

Products of Combustion: Not available.

Fire Hazards in Presence of Various Substances: Not applicable.

Explosion Hazards in Presence of Various Substances:

Risks of explosion of the product in presence of mechanical impact: Not available. Risks of explosion of the product in presence of static discharge: Not available.

Fire Fighting Media and Instructions: Not applicable.

Special Remarks on Fire Hazards: Not available.

Special Remarks on Explosion Hazards: Not available.

Section 6: Accidental Release Measures

Small Spill:

Dilute with water and mop up, or absorb with an inert dry material and place in an appropriate waste disposal container. If necessary: Neutralize the residue with a dilute solution of acetic acid.

Large Spill:

Corrosive liquid. Stop leak if without risk. Absorb with DRY earth, sand or other non-combustible material. Do not get water inside container. Do not touch spilled material. Use water spray curtain to divert vapor drift. Prevent entry into sewers, basements or confined areas; dike if needed. Call for assistance on disposal. Neutralize the residue with a dilute solution of acetic acid. Be careful that the product is not present at a concentration level above TLV. Check TLV on the MSDS and with local authorities.

Section 7: Handling and Storage

Precautions:

Keep container dry. Do not breathe gas/fumes/ vapour/spray. Never add water to this product In case of insufficient ventilation, wear suitable respiratory equipment If you feel unwell, seek medical attention and show the label when possible. Avoid contact with skin and eyes Keep away from incompatibles such as acids.

Storage:

Alkalis may be stored in heavy duty gauge steel containers. Corrosive materials should be stored in a separate safety storage cabinet or room.

Section 8: Exposure Controls/Personal Protection

Engineering Controls:

Provide exhaust ventilation or other engineering controls to keep the airborne concentrations of vapors below their respective threshold limit value.

Personal Protection:

Face shield. Full suit. Vapor respirator. Be sure to use an approved/certified respirator or equivalent. Gloves. Boots.

Personal Protection in Case of a Large Spill:

Splash goggles. Full suit. Vapor respirator. Boots. Gloves. A self contained breathing apparatus should be used to avoid inhalation of the product. Suggested protective clothing might not be sufficient; consult a specialist BEFORE handling this product.

Exposure Limits:

Sodium hydroxide CEIL: 2 (mg/m3) from ACGIH [1995] Consult local authorities for acceptable exposure limits.

Section 9: Physical and Chemical Properties

Physical state and appearance: Liquid.

Odor: Odorless.

Taste: Alkaline. Bitter. (Strong.)

Molecular Weight: Not applicable.

Color: Clear Colorless.

pH (1% soln/water): Basic.

Boiling Point: The lowest known value is 100°C (212°F) (Water).

Melting Point: Not available.

Critical Temperature: Not available.

Specific Gravity: Weighted average: 1.15 (Water = 1)

Vapor Pressure: The highest known value is 17.535 mm of Hg (@ 20°C) (Water).

Vapor Density: The highest known value is 0.62 (Air = 1) (Water).

Volatility: Not available.

Odor Threshold: Not available.

Water/Oil Dist. Coeff.: Not available.

Ionicity (in Water): Not available.

Dispersion Properties: See solubility in water.

Solubility: Easily soluble in cold water.

Section 10: Stability and Reactivity Data

Stability: The product is stable.

Instability Temperature: Not available.

Conditions of Instability: Not available.

Incompatibility with various substances: Extremely reactive or incompatible with acids.

Corrosivity:

Highly corrosive in presence of aluminum. Slightly corrosive to corrosive in presence of glass.

Special Remarks on Reactivity: Not available.

Special Remarks on Corrosivity: Not available.

Polymerization: No.

Section 11: Toxicological Information

Routes of Entry: Eye contact. Inhalation. Ingestion.

Toxicity to Animals:

LD50: Not available. LC50: Not available.

Chronic Effects on Humans: The substance is toxic to lungs, mucous membranes.

Other Toxic Effects on Humans:

Very hazardous in case of skin contact (corrosive, irritant), of ingestion. Hazardous in case of inhalation.

Special Remarks on Toxicity to Animals: Not available.

Special Remarks on Chronic Effects on Humans: Not available.

Special Remarks on other Toxic Effects on Humans: Not available.

Section 12: Ecological Information

Ecotoxicity: Not available.

BOD5 and COD: Not available.

Products of Biodegradation:

Possibly hazardous short term degradation products are not likely. However, long term degradation products may arise.

Toxicity of the Products of Biodegradation: The product itself and its products of degradation are not toxic.

Special Remarks on the Products of Biodegradation: Not available.

Section 13: Disposal Considerations

Waste Disposal:

Section 14: Transport Information

DOT Classification: CLASS 8: Corrosive liquid.

Identification: : Sodium hydroxide, solution (Sodium hydroxide) : UN1824 PG: II

Special Provisions for Transport: Not available.

Section 15: Other Regulatory Information

Federal and State Regulations:

Pennsylvania RTK: Sodium hydroxide Massachusetts RTK: Sodium hydroxide TSCA 8(b) inventory: Sodium hydroxide; Water

Other Regulations: OSHA: Hazardous by definition of Hazard Communication Standard (29 CFR 1910.1200).

Other Classifications:

WHMIS (Canada):

CLASS D-2A: Material causing other toxic effects (VERY TOXIC). CLASS E: Corrosive liquid.

DSCL (EEC): R35- Causes severe burns.

HMIS (U.S.A.):

Health Hazard: 2

Fire Hazard: 0

Reactivity: 0

Personal Protection:

National Fire Protection Association (U.S.A.):

Health: 2

Flammability: 0

Reactivity: 0

Specific hazard:

Protective Equipment:

Gloves. Full suit. Vapor respirator. Be sure to use an approved/certified respirator or equivalent. Wear appropriate respirator when ventilation is inadequate. Face shield.

Section 16: Other Information

References: Not available.

Other Special Considerations: Not available.

Created: 10/10/2005 12:05 PM

Last Updated: 05/21/2013 12:00 PM

The information above is believed to be accurate and represents the best information currently available to us. However, we make no warranty of merchantability or any other warranty, express or implied, with respect to such information, and we assume

no liability resulting from its use. Users should make their own investigations to determine the suitability of the information for their particular purposes. In no event shall ScienceLab.com be liable for any claims, losses, or damages of any third party or for lost profits or any special, indirect, incidental, consequential or exemplary damages, howsoever arising, even if ScienceLab.com has been advised of the possibility of such damages.

ISOPLUS

MSDS ID: 02450

I. CHEMICAL PRODUCT AND COMPANY IDENTIFICATION

Product Name: ISOPLUS

Product Descriptor: BOILER TREATMENT COMPOUND

MANUFACTURER: DUBOIS CHEMICALS, INC.

EMERGENCY PHONE NUMBER: (866) 923-4919

3630 E. KEMPER ROAD

CINCINNATI, OH. 45241

II. HAZARDOUS COMPONENTS

Component Name	CAS Number	%	Exposure Limits	Units
POTASSIUM METABISULFITE	16731-55-8	5 - 15%	None established	
POTASSIUM SULFITE	10117-38-7	5 - 15%	None established	
SODIUM METABISULFITE	7681-57-4	5 - 15%	TLV 5	MG/M3
SODIUM SULFITE (7757-83-7)		5 - 15%	None established	

III. HAZARDS IDENTIFICATION

EMERGENCY OVERVIEW:

WARNING - Contains chemicals that cause irritation to eyes and skin. May be harmful if swallowed. Wear eye protection, clothing and rubber gloves to prevent prolonged skin contact. Wash after handling.

POSSIBLE ROUTES OF ENTRY: Inhalation and ingestion.

SIGNS AND SYMPTOMS OF OVEREXPOSURE

ACUTE: EYES: Causes eye irritation. SKIN: Causes skin irritation.

INGESTION: If swallowed, may cause gastric distress, diarrhea, vomiting and possible depression of the central nervous system (CNS). INHALATION: May cause irritation of respiratory tract.

CHRONIC: Same as acute effects.

MEDICAL CONDITIONS GENERALLY AGGRAVATED BY EXPOSURE: Dermatitis, sensitive skin, pulmonary function and asthma.

TARGET ORGAN(S) OF CHEMICAL HAZARD(S): Eyes, skin, respiratory tract, and gastrointestinal tract.

IV. FIRST AID MEASURES

EYES: Immediately flush eyes with plenty of water for 15 minutes. Get medical attention.

SKIN: Flush skin with plenty of water and wash with mild soap. If irritation develops, get medical attention.

INGESTION: If swallowed, rinse mouth with water. Dilute by drinking several glasses of water. DO NOT induce vomiting. If patient vomits, rerinse mouth. Get immediate medical attention. NOTE: Never give fluids by mouth to an unconscious person.

INHALATION: Remove to fresh air and seek medical attention.

ISOPLUS

MSDS ID: 02450

V. FIRE FIGHTING MEASURES

FLASH POINT (degrees F): NONE FLAME EXTENSION: N/A
FLAMMABLE LIMITS IN AIR BY VOLUME: LEL: NONE UEL: NONE
UNUSUAL FIRE OR EXPLOSIVE HAZARDS: Toxic fumes or vapor may form during fire.
EXTINGUISHING MEDIA: Water, water spray, CO2, foam or dry powder.
FIRE FIGHTING INSTRUCTIONS: Wear full protective gear and positive pressure breathing apparatus (SCBA) in fire area.
SPECIAL INSTRUCTIONS: Spilled product may cause slippery surface and fall hazard.

VI. ACCIDENTAL RELEASE MEASURES

IF MATERIAL IS RELEASED OR SPILLED:
Flush small amounts to drain. Collect and return large amounts to container.
This product does not contain a reportable quantity (RQ) under CERCLA.

VII. HANDLING AND STORAGE

HANDLING AND STORAGE PRECAUTIONS: Store in a cool, dry area, keep away from acids. Keep container closed when not in use. Wear protective gear when handling or using. Do not pressurize container to empty.

VIII. EXPOSURE CONTROLS/PERSONAL PROTECTION

EYE/FACE PROTECTION: Safety glasses with side shields. Chemical goggles if contact or splash hazard exists.
PROTECTIVE GLOVES: Liquid proof gloves.
RESPIRATORY PROTECTION: Product does not have any established exposure limits. NIOSH/MSHA approved respirator recommended in enclosed or confined spaces where high air concentration or long exposure may occur.
OTHER PROTECTIVE CLOTHING/EQUIPMENT: Chemical apron.
ENGINEERING CONTROLS:
VENTILATION: Good general ventilation should be sufficient to control airborne levels.

IX. PHYSICAL AND CHEMICAL PROPERTIES

APPEARANCE AND ODOR: Clear liquid, mild odor.

BOILING POINT (DEG F): 215 FREEZING POINT: 20 F
SPECIFIC GRAVITY/BULK DENSITY: 1.25
pH: 7.3 pH 1% SOLUTION: 7.0
VOLATILE BY VOLUME: 72
SOLUBILITY IN WATER: Soluble
VAPOR PRESSURE(mmHg): 17.5 at 20 C VAPOR DENSITY: 17.3

ISOPLUS

MSDS ID: 02450

X. STABILITY AND REACTIVITY

CHEMICAL STABILITY: STABLE

INCOMPATIBILITY WITH OTHER MATERIALS: Acids

HAZARDOUS DECOMPOSITION PRODUCTS: Incomplete combustion forms; oxides of sulfur; oxides of carbon

HAZARDOUS POLYMERIZATION: None known.

XI. TOXICOLOGICAL INFORMATION

TOXICOLOGICAL TESTING: Toxicological testing has not been performed on the product. Listed below is the available toxicology test data for components of the product.

TOXICITY TEST DATA:

Sodium Metabisulfite:

Oral LD50	(rat)	>2 gm/kg
Dermal LD50	(rat)	>2 gm/kg
Intravenous LD50	(rat)	115 mg/kg
Parenteral LD50	(rat)	910 mg/kg

XII. ECOLOGICAL INFORMATION

Toxicological testing has not been performed on the product. Listed below is the available toxicology test data for components of the product.

ECOTOXICITY TEST DATA:

Sodium Metabisulfite:

LC50 (96 hr) (Gambusia affinis) 120 mg/l

ENVIRONMENTAL FATE: No data available.

XIII. DISPOSAL CONSIDERATIONS

RCRA REGULATED: Not Regulated.

Discharge diluted product to industrial sewer in accordance with discharge permit or local POTW regulations. Use product in container until empty. Rinse container with water. Recycle or dispose of container according to product labeling or governmental regulations.

XIV. TRANSPORT INFORMATION

Please refer to the Bill of Lading/receiving documents for up to date shipping information.

XV. REGULATORY INFORMATION

U.S. Federal Regulations:

TSCA: All ingredients in this product are on TSCA inventory.

HAPS: NONE

VOC CONTENT (EPA Method 24A): % VOC: 0 Lb/Gal VOC: 0

CERCLA/EPCRA:

Section 313 Toxic Chemicals:

NONE

SARA Section 311/312:

ISOPLUS

MSDS ID: 02450

XV. REGULATORY INFORMATION (Cont.)

ACUTE:YES CHRONIC:NO FIRE:NO REACTIVITY:NO
SUDDEN RELEASE OF PRESSURE:NO

LISTED CARCINOGEN: NONE

NTP: NO IARC: NO OSHA: NO

HMIS RATINGS: HEALTH: 2 FIRE: 0 REACTIVITY: 0

PERSONAL PROTECTIVE EQUIPMENT: C

NFPA RATING: HEALTH: 2 FIRE: 0 REACTIVITY:0 SPECIAL:IRRITANT

STATE RIGHT-TO-KNOW INFORMATION:

SODIUM SULFITE - CAS #7757-83-7

WATER - CAS #7732-18-5

POTASSIUM SULFITE - CAS #10117-38-1

SODIUM METABISULFITE - CAS #7681-57-4

POTASSIUM METABISULFITE - CAS #16731-55-8

CALIFORNIA PROPOSITION 65:

None of the ingredients are on the California proposition 65 list.

XVI. OTHER INFORMATION

Disclaimer: The information contained in this material safety data sheet is based on the knowledge of this specific product and current national legislation. It applies to the product as sold, use dilutions may be less hazardous. It may not be valid for this material if used in combination with any other materials or in a process. It is the user's responsibility to evaluate the handling, and use.



CONDEN-SAF 4675

HMIS		NFPA	Personal protective equipment		
Health	3	3	  		
Fire Hazard	2	2			
Reactivity	0	0			

Version Number: 2

Preparation date: 2008-12-01

1. PRODUCT AND COMPANY IDENTIFICATION

Product name: CONDEN-SAF 4675
MSDS #: MS0100823
Product Code: 00632070, 00632150, 00632470
Recommended use: Condensate line corrosion inhibitor .

Manufacturer, importer, supplier:
 DuBois Chemicals, Inc. Canadian Headquarters
 3630 E. Kemper Rd. DuBois Chemicals Canada, Inc.
 Cincinnati, OH 45241 3450 Ridgeway Drive, Unit 2
 Phone: 1-800-438-2647 Mississauga, Ontario L5L 0A2
 Phone: 1-866-861-3603

Emergency telephone number: 1-866-923-4919 (US and Canada); 01-651-523-0314 (Int'l and México)

2. HAZARDS IDENTIFICATION

EMERGENCY OVERVIEW

DANGER. CORROSIVE. CAUSES SKIN AND EYE BURNS. HARMFUL OR FATAL IF SWALLOWED. COMBUSTIBLE LIQUID AND VAPOR.

Principle routes of exposure: Eye contact. Skin contact. Inhalation. Ingestion.
Eye contact: Corrosive. Causes permanent eye damage, including blindness.
Skin contact: Corrosive. Causes permanent damage.
Inhalation: May cause irritation and corrosive effects to nose, throat and respiratory tract.
Ingestion: Corrosive. Causes burns to mouth, throat and stomach.

3. COMPOSITION/INFORMATION ON INGREDIENTS

Hazardous ingredients

Ingredient(s)	CAS #	Weight %	LD50 Oral - Rat (mg/kg)	LD50 Dermal - Rabbit	LC50 Inhalation - Rat
Morpholine	110-91-8	10 - 20%	1050	=310 mg/kg	8000 ppm (8h)
Diethylaminoethanol	100-37-8	10 - 20%	1300	=1260 mg/kg	Not available
Cyclohexylamine	108-91-8	10 - 20%	11	=208 mg/kg	>0.7 mg/L (4 h) >1.5 mg/L (1 h)

4. FIRST AID MEASURES

Eye contact: Immediately flush eyes with running water for at least 15-20 minutes, keeping eyelids open. Get medical attention immediately.
Skin contact: Flush immediately with plenty of water for at least 15-20 minutes. Get medical attention immediately.
Inhalation: If breathing is affected, remove to fresh air. Get medical attention immediately.
Ingestion: If swallowed, give a cupful of water or milk. THEN IMMEDIATELY CONTACT A PHYSICIAN OR POISON CENTER. DO NOT induce vomiting unless directed to do so by medical personnel. Never give anything by mouth to an unconscious person.
Aggravated Medical Conditions: Individuals with chronic respiratory disorders such as asthma, chronic bronchitis, emphysema, etc., may be more susceptible to irritating effects.

5. FIRE-FIGHTING MEASURES

Suitable extinguishing media: Dry chemical, water spray, foam, carbon dioxide.
Specific hazards: Keep product and empty container away from heat and sources of ignition.
Unusual hazards: None known
Specific methods: No special methods required

5. FIRE-FIGHTING MEASURES

Special protective equipment for firefighters: As in any fire, wear self-contained breathing apparatus pressure-demand, MSHA/NIOSH (approved or equivalent) and full protective gear

Extinguishing media which must not be used for safety reasons: No information available

6. ACCIDENTAL RELEASE MEASURES

Personal precautions:

Contaminated surfaces will be extremely slippery. Use personal protective equipment.

Environmental precautions and clean-up methods:

Clean-up methods - large spillage. Prevent product from entering drains. Absorb spill with inert material (e.g. dry sand or earth), then place in a chemical waste container. Use a water rinse for final clean-up.

7. HANDLING AND STORAGE

Handling:

Avoid contact with skin, eyes and clothing. Do not taste or swallow. Avoid breathing vapors or mists. Use only with adequate ventilation. Remove and wash contaminated clothing and footwear before re-use. Wash thoroughly after handling. Product residue may remain on/in empty containers. All precautions for handling the product must be used in handling the empty container and residue. FOR COMMERCIAL AND INDUSTRIAL USE ONLY.

Storage:

Protect from freezing. Keep tightly closed in a dry, cool and well-ventilated place. Keep away from heat. KEEP OUT OF REACH OF CHILDREN.

8. EXPOSURE CONTROLS / PERSONAL PROTECTION

Engineering measures to reduce exposure:

Good general ventilation should be sufficient to control airborne levels.

Personal Protective Equipment

Eye protection:

Chemical-splash goggles.

Hand protection:

Chemical-resistant gloves

Skin and body protection:

Protective footwear. If major exposure is possible, wear suitable protective clothing and footwear.

Respiratory protection:

In case of insufficient ventilation wear suitable respiratory equipment. A respiratory protection program that meets OSHA's 29 CFR 1910.134 and ANSI Z88.2 requirements must be followed whenever workplace conditions warrant a respirator's use.

Hygiene measures:

Handle in accordance with good industrial hygiene and safety practice

Ingredient(s)	CAS #	ACGIH	OSHA	Mexico
Morpholine	110-91-8	20 ppm (TWA)	Skin 20 ppm (TWA) 70 mg/m ³ (TWA)	105 mg/m ³ (STEL) 30 ppm (STEL) 70 mg/m ³ (TWA) 20 ppm (TWA)
Diethylaminoethanol	100-37-8	2 ppm (TWA)	Skin 10 ppm (TWA) 50 mg/m ³ (TWA)	10 ppm (TWA) 50 mg/m ³ (TWA)
Cyclohexylamine	108-91-8	10 ppm (TWA)		40 mg/m ³ (TWA) 10 ppm (TWA)

9. PHYSICAL AND CHEMICAL PROPERTIES

Physical State: Liquid

pH: 12

Appearance: Liquid

Color: Clear

Odor: Amine

Specific gravity: 0.995 g/mL

Density: 8.3 lbs/gal

VOC: 40% *

Flash point: 145°F 97.5°C

Solubility: completely soluble

Viscosity: No information available

Bulk density: No information available

Dilution pH: 10.9

Vapor density: No information available

Evaporation Rate: No information available

Boiling point/range: <200°F >100°C

Melting point/range: Not determined

Decomposition temperature: Not determined

Autoignition temperature: No information available

Partition coefficient (n-octanol/water): No information available

Solubility in other solvents: No information available

Elemental Phosphorus: 0 %P

* - Title 17, California Code of Regulations, Division 3, Chapter 1, Subchapter 8.5, Article 2, Consumer Products, Sections 94508

10. STABILITY AND REACTIVITY

Stability:

Stable.

Polymerization:

Hazardous polymerization does not occur

Hazardous decomposition products:

None reasonably foreseeable.

11. TOXICOLOGICAL INFORMATION

11. TOXICOLOGICAL INFORMATION

Acute toxicity:	Oral LD50 estimated to be between 500 - 2000 mg/kg. Corrosive.
Component Information:	See Section 3
Chronic toxicity:	None known
Specific effects	
Carcinogenic effects:	None known
Mutagenic effects:	None known
Reproductive toxicity:	None known
Target organ effects:	None known

Hazardous ingredients

Ingredient(s)	CAS #	NTP	IARC	OSHA
Cyclohexylamine	108-91-8		3	

12. ECOLOGICAL INFORMATION

Environmental Information: No data available

13. DISPOSAL CONSIDERATIONS

Waste from residues / unused products:

Undiluted product is regulated under environmental and transportation laws as a corrosive waste. Dispose of according to all federal, state and local applicable regulations.

RCRA Hazard Class: D002

14. TRANSPORT INFORMATION

DOT/TDG: Please refer to the Bill of Lading/receiving documents for up to date shipping information

15. REGULATORY INFORMATION

International Inventories

All components of this product are listed on the following inventories: U.S.A. (TSCA), Canada (DSL/NDSL), Europe (EINECS/ELINCS/NLP), Australia (AICS), Korea (ECL), Japan (ENCS), Philippines (PICCS), New Zealand (NZIoC), China (IECSC).

U.S. Regulations

California Proposition 65: This product is not subject to the reporting requirements under California's Proposition 65

STATE RIGHT TO KNOW

Ingredient(s)	CAS #	MARTK:	NJRTK:	PARTK:	RIRTK:
Morpholine	110-91-8	X	X	X	X
Water	7732-18-5	-	-	-	-
Diethylaminoethanol	100-37-8	X	X	X	X
Cyclohexylamine	108-91-8	X	X	X	X

CERCLA/ SARA

Ingredient(s)	CAS #	Weight %	CERCLA/SARA RQ (lbs)	Section 302 TPQ (lbs)	Section 313
Cyclohexylamine	108-91-8	10 - 20%		10000	

SARA 311/312 Hazard Categories

Immediate:	X
Delayed:	-
Fire:	X
Reactivity:	-
Sudden Release of Pressure:	-

Canada

WHMIS hazard class: E Corrosive material , B3 Combustible liquid .



16. OTHER INFORMATION

Reason for revision: Not applicable
Prepared by: NAPRAC
Additional advice: None

16. OTHER INFORMATION

Notice to Reader: This document has been prepared using data from sources considered technically reliable. It does not constitute a warranty, express or implied, as to the accuracy of the information contained within. Actual conditions of use and handling are beyond seller's control. User is responsible to evaluate all available information when using product for any particular use and to comply with all Federal, State, Provincial and Local laws and regulations.

Material Safety Data Sheet



DUBOIS OH 50

1. Product and company identification

Product name : DUBOIS OH 50
Supplier/Manufacturer : DuBois Chemicals, Inc.
3630 E. Kemper Rd.
Cincinnati, OH 45241 USA
Phone: 1-800-438-2647

DuBois Chemicals Canada, Inc.
1155 North Service Road West
Unit 6
Oakville, Ontario, L6M 3E3 Canada
Phone: 1-866-861-3603

Recommended use : Industrial applications: Alkaline Cleaner ADDITIVE
MSDS # : MS0127133
Product code : 11728470, 11728300
Validation date : 12/12/2011.
Version : 1
Responsible name : Regulatory Department 1-800-438-2647
In case of emergency : 1-866-923-4919 (US and Canada)
01-651-523-0314 (Int'l and Mexico)

Hazardous Material Information System (U.S.A.)

Health	*	3
Flammability		0
Physical hazards		1

2. Hazards identification

Physical state : Liquid.
OSHA/HCS status : This material is considered hazardous by the OSHA Hazard Communication Standard (29 CFR 1910.1200).
Emergency overview : DANGER!
CORROSIVE. CAUSES DIGESTIVE TRACT, EYE AND SKIN BURNS.
Do not breathe vapor or mist. Do not ingest. Do not get in eyes or on skin or clothing. Use only with adequate ventilation. Keep container tightly closed and sealed until ready for use. Wash thoroughly after handling.
Routes of entry : Dermal contact. Eye contact. Inhalation.
Potential acute health effects
Inhalation : May give off gas, vapor or dust that is very irritating or corrosive to the respiratory system.
Ingestion : Corrosive to the digestive tract. Causes burns.
Skin : Corrosive to the skin. Causes burns.
Eyes : Corrosive to eyes. Causes burns.
Potential chronic health effects
Carcinogenicity : No known significant effects or critical hazards.
Target organs : Contains material which may cause damage to the following organs: upper respiratory tract, skin, eye, lens or cornea, stomach.

2. Hazards identification

Medical conditions aggravated by over-exposure : Pre-existing disorders involving any target organs mentioned in this MSDS as being at risk may be aggravated by over-exposure to this product.

See toxicological information (section 11)

3. Composition/information on ingredients

Name	CAS number	% by weight
sodium hydroxide	1310-73-2	40 - 50
sodium chloride	7647-14-5	1 - 5

There are no additional ingredients present which, within the current knowledge of the supplier and in the concentrations applicable, are classified as hazardous to health or the environment and hence require reporting in this section.

4. First aid measures

- Eye contact** : Check for and remove any contact lenses. Immediately flush eyes with plenty of water for at least 15 minutes, occasionally lifting the upper and lower eyelids. Get medical attention immediately.
- Skin contact** : In case of contact, immediately flush skin with plenty of water for at least 15 minutes while removing contaminated clothing and shoes. Wash clothing before reuse. Clean shoes thoroughly before reuse. Get medical attention immediately.
- Inhalation** : Move exposed person to fresh air. If not breathing, if breathing is irregular or if respiratory arrest occurs, provide artificial respiration or oxygen by trained personnel. Loosen tight clothing such as a collar, tie, belt or waistband. Get medical attention immediately.
- Ingestion** : Wash out mouth with water. Do not induce vomiting unless directed to do so by medical personnel. Never give anything by mouth to an unconscious person. Get medical attention immediately.
- Protection of first-aiders** : No action shall be taken involving any personal risk or without suitable training. If it is suspected that fumes are still present, the rescuer should wear an appropriate mask or self-contained breathing apparatus. It may be dangerous to the person providing aid to give mouth-to-mouth resuscitation. Wash contaminated clothing thoroughly with water before removing it, or wear gloves.
- Notes to physician** : No specific treatment. Treat symptomatically. Contact poison treatment specialist immediately if large quantities have been ingested or inhaled.

5. Fire-fighting measures

Flammability of the product : In a fire or if heated, a pressure increase will occur and the container may burst.

Extinguishing media

Suitable : Use an extinguishing agent suitable for the surrounding fire.

Not suitable : None known.

Special exposure hazards : Promptly isolate the scene by removing all persons from the vicinity of the incident if there is a fire. No action shall be taken involving any personal risk or without suitable training.

Hazardous thermal decomposition products : Decomposition products may include the following materials:
halogenated compounds
metal oxide/oxides

Special protective equipment for fire-fighters : Fire-fighters should wear appropriate protective equipment and self-contained breathing apparatus (SCBA) with a full face-piece operated in positive pressure mode.

6. Accidental release measures

- Personal precautions** : No action shall be taken involving any personal risk or without suitable training. Evacuate surrounding areas. Keep unnecessary and unprotected personnel from entering. Do not touch or walk through spilled material. Do not breathe vapor or mist. Provide adequate ventilation. Wear appropriate respirator when ventilation is inadequate. Put on appropriate personal protective equipment (see section 8).
- Environmental precautions** : Avoid dispersal of spilled material and runoff and contact with soil, waterways, drains and sewers. Inform the relevant authorities if the product has caused environmental pollution (sewers, waterways, soil or air).
- Methods for cleaning up**
- Small spill** : Stop leak if without risk. Move containers from spill area. Dilute with water and mop up if water-soluble. Alternatively, or if water-insoluble, absorb with an inert dry material and place in an appropriate waste disposal container. Dispose of via a licensed waste disposal contractor.
- Large spill** : Stop leak if without risk. Move containers from spill area. Approach release from upwind. Prevent entry into sewers, water courses, basements or confined areas. Wash spillages into an effluent treatment plant or proceed as follows. Contain and collect spillage with non-combustible, absorbent material e.g. sand, earth, vermiculite or diatomaceous earth and place in container for disposal according to local regulations (see section 13). Dispose of via a licensed waste disposal contractor. Contaminated absorbent material may pose the same hazard as the spilled product. Note: see section 1 for emergency contact information and section 13 for waste disposal.

7. Handling and storage

- Handling** : Put on appropriate personal protective equipment (see section 8). Eating, drinking and smoking should be prohibited in areas where this material is handled, stored and processed. Workers should wash hands and face before eating, drinking and smoking. Do not get in eyes or on skin or clothing. Do not breathe vapor or mist. Do not ingest. If during normal use the material presents a respiratory hazard, use only with adequate ventilation or wear appropriate respirator. Keep in the original container or an approved alternative made from a compatible material, kept tightly closed when not in use. Keep away from acids. Empty containers retain product residue and can be hazardous. Do not reuse container.
- Storage** : Store in accordance with local regulations. Store in original container protected from direct sunlight in a dry, cool and well-ventilated area, away from incompatible materials (see section 10) and food and drink. Separate from acids. Keep container tightly closed and sealed until ready for use. Containers that have been opened must be carefully resealed and kept upright to prevent leakage. Do not store in unlabeled containers. Use appropriate containment to avoid environmental contamination.

8. Exposure controls/personal protection

Occupational exposure limits

Ingredient	Exposure limits
sodium hydroxide	ACGIH TLV (United States, 2/2010). C: 2 mg/m ³ OSHA PEL (United States, 6/2010). TWA: 2 mg/m ³ 8 hour(s).

Consult local authorities for acceptable exposure limits.

- Recommended monitoring procedures** : If this product contains ingredients with exposure limits, personal, workplace atmosphere or biological monitoring may be required to determine the effectiveness of the ventilation or other control measures and/or the necessity to use respiratory protective equipment.
- Engineering measures** : If user operations generate dust, fumes, gas, vapor or mist, use process enclosures, local exhaust ventilation or other engineering controls to keep worker exposure to airborne contaminants below any recommended or statutory limits.

8. Exposure controls/personal protection

Hygiene measures : Wash hands, forearms and face thoroughly after handling chemical products, before eating, smoking and using the lavatory and at the end of the working period. Appropriate techniques should be used to remove potentially contaminated clothing. Wash contaminated clothing before reusing. Ensure that eyewash stations and safety showers are close to the workstation location.

Personal protection

Respiratory : Use a properly fitted, air-purifying or air-fed respirator complying with an approved standard if a risk assessment indicates this is necessary. Respirator selection must be based on known or anticipated exposure levels, the hazards of the product and the safe working limits of the selected respirator.

Hands : Chemical-resistant, impervious gloves complying with an approved standard should be worn at all times when handling chemical products if a risk assessment indicates this is necessary.

Recommended: nitrile rubber

Eyes : Safety eyewear complying with an approved standard should be used when a risk assessment indicates this is necessary to avoid exposure to liquid splashes, mists or dusts. Recommended: splash goggles

Skin : Personal protective equipment for the body should be selected based on the task being performed and the risks involved and should be approved by a specialist before handling this product.

Environmental exposure controls : Emissions from ventilation or work process equipment should be checked to ensure they comply with the requirements of environmental protection legislation. In some cases, fume scrubbers, filters or engineering modifications to the process equipment will be necessary to reduce emissions to acceptable levels.

Personal protective equipment (Pictograms) :



9. Physical and chemical properties

Physical state : Liquid.

Flash point : Closed cup: >93.333°C (>200°F) [Pensky-Martens.]

Color : Colorless.

Odor : Not available.

pH : >13.5

Dilution pH : >13 [Conc. (% w/w): 1%]

Boiling/condensation point : Not available.

Melting/freezing point : Not available.

Specific gravity : 1.53

Density : 12.76785 lbs/gal

Vapor pressure : Not available.

Vapor density : Not available.

Odor threshold : Not available.

Evaporation rate : Not available.

Solubility : Easily soluble in the following materials: cold water and hot water.

Elemental Phosphorus : 0 %

Octanol/water partition coefficient : Not available.

10. Stability and reactivity

- Chemical stability** : The product is stable.
- Conditions to avoid** : No specific data.
- Materials to avoid** : Reactive or incompatible with the following materials:
acids
- Hazardous decomposition products** : Under normal conditions of storage and use, hazardous decomposition products should not be produced.
- Possibility of hazardous reactions** : Under normal conditions of storage and use, hazardous reactions will not occur.

11. Toxicological information

Acute toxicity

Product/ingredient name	Result	Species	Dose	Exposure
sodium chloride	LD50 Oral	Rat	3000 mg/kg	-

Carcinogenicity

None known.

Acute toxicity estimates

Not available.

12. Ecological information

- Ecotoxicity** : No known significant effects or critical hazards.

Aquatic ecotoxicity

None known.

13. Disposal considerations

- Waste disposal** : The generation of waste should be avoided or minimized wherever possible. Empty containers or liners may retain some product residues. This material and its container must be disposed of in a safe way. Dispose of surplus and non-recyclable products via a licensed waste disposal contractor. Disposal of this product, solutions and any by-products should at all times comply with the requirements of environmental protection and waste disposal legislation and any regional local authority requirements. Avoid dispersal of spilled material and runoff and contact with soil, waterways, drains and sewers.

- RCRA classification** : D002 [corrosive]

Disposal should be in accordance with applicable regional, national and local laws and regulations.

Refer to Section 7: HANDLING AND STORAGE and Section 8: EXPOSURE CONTROLS/PERSONAL PROTECTION for additional handling information and protection of employees.

14. Transport information

IATA/IMDG/DOT/TDG: Please refer to the Bill of Lading/receiving documents for up to date shipping information.

15. Regulatory information

United States

- U.S. Federal regulations** : **TSCA 12(b) one-time export**: No products were found.
TSCA 12(b) annual export notification: No products were found.

- United States inventory (TSCA 8b)** : All components are listed or exempted.

SARA 311/312 MSDS distribution - chemical inventory - hazard identification:
DUBOIS OH 50: reactive, Immediate (acute) health hazard

SARA 302/304/311/312 extremely hazardous substances: No products were found.
CERCLA: Hazardous substances.: sodium hydroxide: 1000 lbs. (454 kg);

15. Regulatory information

SARA 313

None identified.

State regulations

- Massachusetts** : The following components are listed: SODIUM HYDROXIDE
Rhode Island : None of the components are listed.
New Jersey : The following components are listed: SODIUM HYDROXIDE; CAUSTIC SODA
Pennsylvania : The following components are listed: SODIUM HYDROXIDE (NA(OH))

California Prop. 65

None of the components are listed.

Canada

- WHMIS (Canada)** : Class D-1B: Material causing immediate and serious toxic effects (Toxic).
Class E: Corrosive material

- WHMIS (Pictograms)** :



Canadian lists

- Canadian NPRI** : None of the components are listed.
Canada inventory : All components are listed or exempted.

This product has been classified in accordance with the hazard criteria of the Controlled Products Regulations and the MSDS contains all the information required by the Controlled Products Regulations.

International regulations

- International lists** : **Australia inventory (AICS)**: All components are listed or exempted.
China inventory (IECSC): All components are listed or exempted.
Japan inventory: All components are listed or exempted.
Korea inventory: All components are listed or exempted.
New Zealand Inventory of Chemicals (NZIoC): All components are listed or exempted.
Philippines inventory (PICCS): All components are listed or exempted.
- Europe inventory** : All components are listed or exempted.

16. Other information

Hazardous Material Information System (U.S.A.) :

Health	*	3
Flammability		0
Physical hazards		1

Caution: HMIS® ratings are based on a 0-4 rating scale, with 0 representing minimal hazards or risks, and 4 representing significant hazards or risks. Although HMIS® ratings are not required on MSDSs under 29 CFR 1910.1200, the preparer may choose to provide them. HMIS® ratings are to be used with a fully implemented HMIS® program. HMIS® is a registered mark of the National Paint & Coatings Association (NPCA). HMIS® materials may be purchased exclusively from J. J. Keller (800) 327-6868.

The customer is responsible for determining the PPE code for this material.

- Date of issue** : 12/12/2011.
Date of previous issue : No previous validation.
Version : 1

☑ Indicates information that has changed from previously issued version.

Notice to reader

16. Other information

To the best of our knowledge, the information contained herein is accurate. However, neither the above-named supplier, nor any of its subsidiaries, assumes any liability whatsoever for the accuracy or completeness of the information contained herein.

Final determination of suitability of any material is the sole responsibility of the user. All materials may present unknown hazards and should be used with caution. Although certain hazards are described herein, we cannot guarantee that these are the only hazards that exist.

Material Safety Data Sheet

Section I			
Product Name	ZT-65		
Emergency Telephone No.	(616) 241 - 4684	Date Issued	3/27/2009
Manufacturer's Name and Address	Mitco, Inc. 1601 Steele S.W. Grand Rapids, MI 49507	Supersedes	10/27/2008
		Chemical Family	Aqueous Mixture
Hazardous Material Description, Shipping Name Hazard Class, Hazard ID No.(49 CFR 172.101)	Corrosive Liquid, Acidic, Organic, N.O.S., (Citric Acid Solution), 8, UN3265, III		

Section II – HAZARDOUS INGREDIENTS								
		Listed as Carcinogen or Potential Carcinogen					Reporting Required	
Chemical Name	CAS Registry Number	National Toxicology Program	I.A.R.C. Monograph	OSHA	OSHA Permissible Exposure Limit	ACGIH Threshold Limit Value	Other Exposure Limit	Sec. 313 of Title III And 40CFR 372
Citric Acid	77-92-9	No	No	No	N/A	N/A	N/A	No

Section III – PHYSICAL DATA			
Boiling Point (°F)	212°F	Specific Gravity (H2O = 1)	1.2-1.3
Vapor Pressure (mm Hg)	17.5 @ 20°C	Percent, Volatile By Volume (%)	N/A
Vapor Density (AIR = 1)	1	Evaporation Rate (Water = 1)	1
Solubility in Water	Complete	pH	1.4
Appearance and Odor	Clear solution with no odor.		

Section IV – FIRE AND EXPLOSION HAZARD DATA				
Flash Point (°F)	>200	Flammable Limits	LEL	N/A
Method Used	N/A		UEL	N/A
Extinguishing Media	Carbon dioxide, dry chemical, foam or water spray.			
Special Fire Fighting Procedures	N/A			
Unusual Fire and Explosion Hazards	N/A			

Section V – HEALTH HAZARD DATA

Primary Routes of Entry	Inhalation	No	Skin Contact	Yes	Eyes	Yes
Effects of Overexposure	Acid solution. Corrosive to skin and eyes. Handle in accordance with good industrial hygiene and safety practices. These practices include avoiding unnecessary exposure and removal of the material from eyes, skin, and clothing.					
Emergency and First Aid Procedures	In case of contact with skin, wash at once with soap and water. For eyes, flush with water for at least 15 minutes and get medical attention. Wash contaminated clothing before reuse.					

Section VI – REACTIVITY DATA

Chemical Stability	Stable	Hazardous Polymerization	Will not occur
Conditions to Avoid	N/A		
Incompatibility (materials to avoid)	None known.		
Hazardous Decomposition Products	None Known		

Section VII – SPILL OR LEAK PROCEDURES

Steps to be taken in Case Material is Released or Spilled	Flush small spills to sanitary sewer with water. Contain large spills.
Waste Disposal Method	Neutralize solution carefully with alkaline material and flush to sanitary drain.

Section VIII – SPECIAL PROTECTION INFORMATION

Respiratory Protection	Not normally necessary.						
Ventilation	Not Necessary	Local Exhaust	N/A	Mechanical (General)	N/A	Special	N/A
Eye Protection	Chemical goggles						
Protective Gloves	Rubber						
Other Protective Clothing or Equipment	Rubber boots and apron if contact appears likely.						

Section IX – SPECIAL PRECAUTIONS

Precautions to be Taken in Handling and Storage	N/A
Other Precautions	N/A



Material Safety Data Sheet

SECTION 1: PRODUCT AND COMPANY IDENTIFICATION

Product Name: Heavy Brine

Synonyms: Mother Liquor, Centrate, Mixed Salt Solution

Manufacturer: Fairmont Brine Processing, LLC

Address: 168 AFR Drive
Fairmont, WV 26554

Emergency Phone: 304-363-9876

WHMIS Classification: Not Controlled

Chemical Family: H₂O, CaCl₂, NaCl, SrCl₂, MgCl₂, KCl

Product Use: De-icing, Dust Control, Drilling & Hydraulic-Fracturing

MSDS Revision Date: June 17th, 2014

Supersedes: December 6th, 2013

SECTION 2: COMPOSITION/INFORMATION ON INGREDIENTS

Composition:

Name	% by Weight	CAS #
Water	60 – 75%	7732-18-5
Calcium chloride	18-24%	10043-52-4
Sodium chloride	7-12%	7647-14-5
Strontium chloride	0-1%	10476-85-4
Magnesium chloride	0-1%	7786-30-3
Potassium chloride	0-1%	7447-40-7

SECTION 3: PHYSICAL STATE

Physical State: Liquid

Appearance/Odor: Colorless, Orange or Rust

Odor Threshold: Odorless

SECTION 4: HAZARDS IDENTIFICATION

Potential Acute Health Effects: Hazardous in case of skin contact (irritant), of eye contact (irritant), of ingestion, of inhalation. Slightly hazardous in case of skin contact (permeator).



Material Safety Data Sheet

Potential Chronic Health Effects:

CARCINOGENIC EFFECTS: Not available.
MUTAGENIC EFFECTS: Mutagenic for mammalian somatic cells. Mutagenic for bacteria and/or yeast. TERATOGENIC EFFECTS: Not available. DEVELOPMENTAL TOXICITY: Not available. The substance may be toxic to heart, cardiovascular system. Repeated or Prolonged exposure to the substance can produce target organs damage.

SECTION 4: FIRST AID MEASURES

Eye Contact:

Check for and remove any contact lenses. In case of contact, immediately flush eyes with plenty of water for at least 15 minutes. Cold water may be used. Get medical attention.

Skin Contact:

In case of contact, immediately flush skin with plenty of water. Cover the irritated skin with an emollient. Remove contaminated clothing and shoes. Cold water may be used. Wash clothing before reuse. Thoroughly clean shoes before reuse. Get medical attention.

Serious Skin Contact:

Wash with a disinfectant soap and cover the contaminated skin with an anti-bacterial cream. Seek immediate medical attention.

Inhalation:

If inhaled, remove to fresh air. If not breathing, give artificial respiration. If breathing is difficult, give oxygen. Get medical attention.

Ingestion:

Do NOT induce vomiting unless directed to do so by medical personnel. Never give anything by mouth to an unconscious person. If large quantities of this material are swallowed, call a physician immediately. Loosen tight clothing such as a collar, tie, belt or waistband.

SECTION 5: FIRE AND EXPLOSION DATA

Flammability of the Product:

Non-flammable.

Auto-Ignition Temperature:

Non-applicable.

Flash Points:

Not applicable.

Flammable Limits:

Not applicable.

Products of Combustion:

Not available.

Fire Hazards in Presence of Various Substances:

Not applicable.

Explosion Hazards in Presence of Various Substances:

Risks of explosion of the product in presence of mechanical impact: Not available. Risks of explosion of the product in presence of static discharge: Not available.



Material Safety Data Sheet

Fire Fighting Meida and Instructions:

Not applicable.

Special Remarks on Fire Hazards:

Not available.

Special Remarks on Explosion Hazards:

Furan-2-peroxycarboxylic acid + calcium chloride causes explosion at room temperature.

SECTION 6: ACCIDENTAL RELEASE MEASURES

Small and/or Large Spill:

Contain spilled material if possible. Absorb with materials such as sand. Use appropriate tools to put the spilled liquid in a suitable and properly labled disposal container. Finish cleaning by spreading water on the contaminated surface and dispose of according to local and regional authority requirements.

SECTION 7: HANDLING AND STORAGE

Storage Conditions:

Keep container tightly closed. Protect from atmospheric moisture.

Handling Procedures:

Avoid contact with skin, eyes and clothing. Wash thoroughly after handling.

SECTION 8: EXPOSURE CONTROLS/PERSONAL PROTECTION

Regulatory Exposure Limit(s):

Component	OSHA Final PEL TWA	OSHA Final PEL STEL	OSHA Final PEL Ceiling
Particles not otherwise regulated	TWA 15 mg/m3 (total) TWA 5 mg/m3 (respirable)	-----	-----

Non-Regulatory Exposure Limit(s):

Component	CAS #	ACGIH TWA	ACGIH STEL	ACGIH Ceiling	OSHA TWA (vacated)	OSHA STEL (vacated)	OSHA Ceiling (vacated)
Particles Not Otherwise Specified (PNOS)	-----	TWA 10 mg/m3 (inhalable) TWA 3 mg/m3 (respirable)	-----	-----	-----	-----	-----

OEL:

Occupational Exposure Limit

OSHA:

United States Occupational Safety and Health Administration

PEL:

Permissible Exposure Limit

TWA:

Time Weighted Average

STEL:

Short Term Exposure Limit



Material Safety Data Sheet

The Non-Regulatory United States Occupational Safety and Health Administration (OSHA) limits shown in the table are the Vacated 1989 PEL's (vacated by 58 FR 35338, June 30, 1993).

- The American Conference of Governmental Industrial Hygienists (ACGIH) is a voluntary organization of professional industrial hygiene personnel in government or educational institutions in the United States. The ACGIH develops and publishes recommended occupational exposure limits each year called Threshold Limit Values (TLVs) for hundreds of chemicals, physical agents, and biological exposure indices.

Engineering Controls:

Use local exhaust ventilation, or other engineering controls to maintain airborne levels below exposure limit requirements or guidelines. If there are no applicable exposure limit requirements or guidelines, general ventilation should be sufficient for most operations. Local exhaust ventilation may be necessary for some operations.

PERSONAL PROTECTIVE EQUIPMENT:

Eye Protection:

Wear chemical safety goggles.

Skin and Body Protection:

Use protective clothing chemically resistant to this material. Selection of specific items such as face shield, boots, apron, or full body suit will depend on the task. Remove contaminated clothing immediately, wash skin area with soap and water, and launder clothing before reuse or dispose of properly.

Hand Protection:

Use gloves chemically resistant to this material. If hands are cut or scratched, use gloves chemically resistant to this material even for brief exposures. Examples of preferred glove barrier materials include: Neoprene, Polyvinyl chloride ("PVC" or "vinyl"), Nitrile/butadiene rubber ("nitrile" or "NBR"). NOTICE: The selection of a specific glove for a particular application and duration of use in a workplace should also take into account all relevant workplace factors such as, but not limited to: Other chemicals which may be handled, physical requirements (cut/puncture protection, dexterity, thermal protection), potential body reactions to glove materials, as well as the instructions/specifications provided by the glove supplier. Avoid gloves made of Polyvinyl alcohol (PVA).

Respiratory Protection:

Respiratory protection should be worn when there is a potential to exceed the exposure limit requirements or guidelines. If there are no applicable exposure limit requirements or guidelines, wear respiratory protection when adverse effects, such as respiratory irritation or discomfort have been experienced, or where indicated by your risk assessment process. In dusty or misty atmospheres, use an approved particulate respirator. The following should be effective types of air-purifying respirators: High efficiency particulate air (HEPA) N95. A respiratory protection program that meets 29 CFR 1910.134 must be followed whenever workplace conditions warrant use of a respirator.

SECTION 9: PHYSICAL AND CHEMICAL PROPERTIES

Physical state and appearance:	Liquid.
Color:	Colorless to orange or rust.
Odor:	Odorless.
Boiling Point/Range:	108 C (226 F) Literature.
Freezing Point/Range:	-15 F to -35 F
Melting Point/Range:	Not applicable.
Decomposition Temperature:	Not applicable.
Vapor Pressure:	16 mmHg@ 25 C Literature.
Vapor Density (air=1):	Not applicable.
Specific Gravity (water=1):	1.219 - 1.263 Literature.
Water Solubility:	Completely miscible.
pH:	5-7.5
Flash point:	Not applicable.
Lower Flammability Level (air):	Not applicable.
Upper Flammability Level (air):	Not applicable.
Autoignition Temperature:	Not applicable.
Viscosity:	2.6 cSt @ 25 C Typical

SECTION 10: STABILITY AND REACTIVITY DATA

Stability:	This product is stable.
Conditions to Avoid:	None known.
Incompatibility with various substances:	Avoid contact with: Sulfuric acid. Flammable hydrogen may be generated from contact with metals such as: Zinc and Sodium. Reaction of bromide impurity with oxidizing materials may generate trace levels of impurities such as bromate.
Corrosivity:	Corrosive to some metals. Avoid contact with metals such as brass, ferrous metals, and mild steel.



Material Safety Data Sheet

Hazardous Decomposition Products:

Does not decompose.

Hazardous Polymerization:

Will not occur.

SECTION 11: TOXICOLOGICAL INFORMATION

Routes of Entry:

Absorbed through skin. Inhalation. Ingestion.

Toxicity to Animals:

Acute oral toxicity (LD50): 918 - 1,668 mg/kg (Rat).

Chronic Effects on Humans:

MUTAGENIC EFFECTS: Mutagenic for mammalian somatic cells. Mutagenic for bacteria and/or yeast. May cause damage to the following organs: heart, cardiovascular system.

Other Toxic Effects on Humans:

Hazardous in case of skin contact (irritant), of ingestion, of inhalation. Slightly hazardous in case of skin contact (permeator).

Special Remarks on Toxicity to Animals:

Lowest Published Lethal Dose: LDL (Rabbit) – Route: Oral; Dose: >5,000 mg/kg

Carcinogenicity:

This product is not classified as a carcinogen by NTP, IARC or OSHA.

SECTION 12: ECOLOGICAL INFORMATION

Fate and Transport:

Material is practically non-toxic to aquatic organisms on an acute basis.

Biodegradation:

Not applicable.

Bioconcentration:

No bioconcentration is expected due to relatively high water solubility. Potential for mobility in soil is very high (Koc between 0 and 50). Partitioning from water to n-octanol is not applicable.

SECTION 13: DISPOSAL CONSIDERATIONS

Disposal:

Reuse or recycle if possible. All disposal practices must be in compliance with all Federal, State/Provincial and local laws and regulations. Regulations may vary in different locations. AS YOUR SUPPLIER, WE HAVE NO CONTROL OVER THE MANAGEMENT PRACTICES OR MANUFACTURING PROCESSES OF PARTIES HANDLING OR USING THIS MATERIAL. THE INFORMATION PRESENTED HERE PERTAINS ONLY TO THE PRODUCT AS SHIPPED IN ITS INTENDED CONDITION AS DESCRIBED IN MSDS SECTION: Composition Information. FOR UNUSED & UNCONTAMINATED PRODUCT, the preferred options include sending to a licensed, permitted: Reclaimer or Waste Water Treatment System.



Material Safety Data Sheet

SECTION 14: TRANSPORT INFORMATION

U.S. Department of Transportation:	As applicable to user's operations and state or country regulations.
Department of Environmental Protection:	As applicable to user's operations and state or country regulations.
Environmental Protection Agency:	As applicable to user's operations and state or country regulations.
State and or County Regulations:	As applicable to user's operations and state or country regulations.

SECTION 15: REGULATORY INFORMATION

OSHA REGULATORY STATUS:	This material is considered hazardous by the OSHA Hazard Communication Standard (29 CFR 1910.1200). CERCLA SECTIONS 102a/103 HAZARDOUS SUBSTANCES (40 CFR 302.4): Not regulated. EPCRA EXTREMELY HAZARDOUS SUBSTANCES (40 CFR 355.30): Not regulated. EPCRA SECTIONS 311/312 HAZARD CATEGORIES (40 CFR 370.10): Acute Health Hazard EPCRA SECTION 313 (40 CFR 372.65): To the best of our knowledge, this product does not contain chemicals at levels which require reporting under this statute. OSHA PROCESS SAFETY (PSM) (29 CFR 1910.119): Not regulated.
--------------------------------	---------------------------------------------------------------------------------------------------------------------------------------------------------------------------------------------------------------------------------------------------------------------------------------------------------------------------------------------------------------------------------------------------------------------------------------------------------------------------------------------------------------------------------------------------------------------------------------------------

SECTION 16: OTHER INFORMATION

References:	Not available.
Other Special Considerations:	Not available.

The information above is believed to be accurate and represents the best information currently available to us. However, we make no warranty of merchantability or any other warranty, express or implied, with respect to such information, and we assume no liability resulting from its use. Users should make their own investigations to determine the suitability of the information for their particular purposes. In no event shall Fairmont Brine Processing, LLC be liable for any claims, losses, or damages of any third party or for lost profits or any special, indirect, incidental, consequential or exemplary damages, howsoever arising, even if Fairmont Brine Processing, LLC has been advised of the possibility of such damages. This information is not intended to be all-inclusive as to the manner and conditions of use, handling, storage, disposal and other factors that may involve other or additional legal, environmental, safety or performance considerations, and Fairmont Brine Processing, LLC assumes no liability whatsoever for the use of or reliance upon this information. While our technical personnel will be happy to respond to questions, safe handling and use of the product remains the responsibility of the customer. No suggestions for use are intended as, and nothing herein shall be construed as, a recommendation to infringe any existing patents or to violate any Federal, State, local or foreign laws. OSHA Standard 29 CFR 1910.1200 requires that information be provided to employees regarding the hazards of chemicals by means of a hazard communication program including labeling, safety data sheets, training and access to written records. Fairmont Brine Processing, LLC requests that you, and it is your legal duty to, make all information in this Material Safety Data Sheet available to your employees.

MATERIAL SAFETY DATA SHEET

Process Salt

FILE NO.: 2.0
MSDS DATE: 1/1/2014

SECTION 1: PRODUCT AND COMPANY IDENTIFICATION

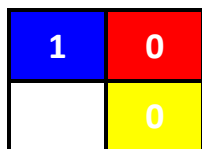

PRODUCT NAME: Process Salt
SYNONYMS: Salt, Road Salt, Rock Salt
MANUFACTURER: Fairmont Brine Processing
ADDRESS: 168 AFR Drive
Fairmont, WV 26554
EMERGENCY PHONE: 304-363-9876
WHMIS Classification: Not Controlled
CHEMICAL FAMILY: Inorganic Salt
PRODUCT USE: De-icing

SECTION 2: COMPOSITION/INFORMATION ON INGREDIENTS

<u>Components:</u>	<u>CAS NO.</u>	<u>% WT</u>
Sodium Chloride	7647-14-5	94.0% to 98%

SECTION 3: PHYSICAL DATA

Physical State:	Solid
Appearance/Odor	White to off-white crystals / odorless
Odor Threshold:	N/A
Specific Gravity:	2.165 g/cm ³
pH:	N/A
Vapor Pressure:	2.4
Solubility in Water:	317 g/L
% Volatile:	N/A
Vapor Density:	N/A

SECTION 4: FIRE AND EXPLOSION HAZARD

Flammability:	No
If yes, under what conditions:	N/A
Means of Extinguishing:	N/A
Special Procedure:	None. Product can be used to extinguish fire.
Flash Point:	N/A
Upper Explosion Limit:	N/A
Lower Explosion Limit:	N/A
Auto Ignition Temperature:	N/A
Sensitivity to Mechanical Impact:	N/A
Sensitivity to Static Discharge:	N/A

SECTION 5: REACTIVITY DATA

Chemical Stability:	Yes
If no, under what condition:	N/A
Incompatibility With Other Substances:	Yes
If so, which ones:	Corrosive to some metals such as brass, mild steel, aluminum or ferrous metals.
Reactivity Under What Conditions:	N/A
Hazardous Decomposition Products:	Chlorine fumes are given off at temperatures >1600°C

MATERIAL SAFETY DATA SHEET

Process Salt

FILE NO.: 2.0
MSDS DATE: 1/1/2014

SECTION 6: HEALTH HAZARDS

Route of Entry:	Skin contact and ingestion
Effect of Acute Exposure to Material:	Moderately toxic LD50 (oral rate): 1000 mg/Kg
Effect of Chronic Exposure to Material:	Unknown
Exposure Limit:	TW AEV for nuisance particulates 10 mg/m ³
Synergetic Material:	None
Irritancy of Material:	Minor irritant
Sensitivity of Material:	Does not occur
Carcinogenic, Reproductive Effects:	None

SECTION 7: FIRST AID MEASURES

Eye Contact:	In case of contact, immediately flush eyes with plenty of water for at least 15 minutes. Cold water may be used. Seek medical attention immediately.
Skin Contact:	Remove from skin by wiping and washing thoroughly with water.
Inhalation:	Remove victim to fresh air.
Ingestion:	If discomfort exists, induce vomiting. Seek medical attention immediately.

SECTION 8: PREVENTATIVE MEASURES

Eye Contact:	Wear safety goggles.
Skin Contact:	Wear rubber gloves, boots and long sleeve shirts.
Inhalation:	For dusty or misty conditions, wear NIOSH approved dust or mist respirator.
Engineering Controls:	Mechanical ventilation recommended in enclosed areas.
Waste Disposal:	Dispose of material in government approved landfill site in accordance with local laws.
Handling Procedures and Equipment:	Wash skin and equipment with water.
Storage Requirements:	Store in cool dry area.
Special Shipping Information:	No special shipping procedures.

SECTION 9: PREPARATION INFORMATION

Prepared By:	Fairmont Brine Processing, LLC
Telephone:	304-363-9876
Preparation Date:	January, 2014
Superseded Date:	All Previous Versions



ATTACHMENT E

SUPPORTING CALCULATIONS



TOTAL EMISSIONS SUMMARY:

E-1: Natural Gas Fired Boiler				
Pollutant	Current Permit Emission Limits		Calculated PTE	
	lb/hour	tons/year	lb/hour	tons/year
CO	3.20	14.02	1.40	6.13
NO _x	3.7	16.21	1.10	4.80
PM	0.30	1.31	0.18	0.79
SO ₂	0.02	0.10	0.02	0.09
VOC	0.21	0.91	0.11	0.50

Proposed modifications have no identified impact on Emissions E-1.

E-2: Natural Gas Fueled Rotary Dryer				
Pollutant	Current Permit Emission Limits		Calculated PTE	
	lb/hour	tons/year	lb/hour	tons/year
CO	0.34	1.48	0.34	1.48
NO _x	0.40	1.76	0.40	1.76
PM	0.03	0.13	0.03	0.13
SO ₂	Not provided	Not provided	0.002	0.01
VOC	0.02	0.10	0.02	0.10

Proposed modifications have no identified impact on Emissions E-2.



TOTAL EMISSIONS SUMMARY (CONTINUED):

E-3: Evaporator				
Pollutant	Current Permit Emission Limits		Calculated PTE <u>with Air Pollution Control Device</u>	
	lb/hour	tons/year	lb/hour	tons/year
VOC	Not provided	Not provided	0.16	0.70
HAP	Not provided	Not provided	0.05	0.23
TAP	Not provided	Not provided	0.03	0.12
Pb	Not provided	Not provided	0.004	0.02
Pollutant	lb/hour	tons/year	lb/hour	tons/year
VOC/HAP	0.15	Not provided	0.18	0.81
Maximum Process Rate of Raw Brine	8,760 gallons per hour		9,450 gallons per hour	

Proposed emissions are greater than the current permit emission limits. FBP plans to replace the existing third effect heat exchanger, 02-HX-003, which will allow for an increase in plant capacity. This change will increase Emissions E-3. Additionally, previous emissions calculations were based on very limited water analyses. These calculations are based on analytical results for ten (10) recent samples pulled from two (2) sample locations. Parameters required under NPDES Permit WV0116408 were analyzed.

E-4: Oil Storage Tank				
Pollutant	Current Permit Emission Limits		Calculated PTE	
	lb/hour	tons/year	lb/hour	tons/year
VOC	Not provided	Not provided	0.06	0.27
Pollutant	lb/year		lb/year	
VOC	546		546	

Proposed modifications have no identified impact on Emissions E-4.



TOTAL EMISSIONS SUMMARY (CONTINUED):

E-6: Lime Silo				
Pollutant	Current Permit Emission Limits		Calculated PTE	
	lb/hour	tons/year	lb/hour	tons/year
PM	NA	NA	0.07	0.02

FBP plans to expand their pretreatment operations to include chemical precipitation, clarification, and effluent and sludge processing. This includes the installation of a lime silo, 01-TK-015 (new Emissions E-6).

E-7: Natural Gas Fired Boiler				
Pollutant	Current Permit Emission Limits		Calculated PTE	
	lb/hour	tons/year	lb/hour	tons/year
CO	NA	NA	1.24	5.43
NO _x	NA	NA	2.31	10.14
PM	NA	NA	0.19	0.81
SO ₂	NA	NA	0.02	0.09
VOC	NA	NA	0.12	0.52

FBP plans to install a second natural gas fueled boiler, 03-B-002 (new Emissions E-7) to provide a redundant heat source for the evaporation process.



DETAILED CALCULATIONS:

Emissions Point E-1: Natural Gas Fired Boiler

Boiler Specification	
Manufacturer	Hurst Boiler and Welding Company Inc.
Model No.	Scotch S400-G-900-300
Serial No.	S4500-300-5
Boiler output (MBH)	30,128
Horsepower	900
Maximum design steaming capacity (lb/hour)	31,050
Annual operating hours	8,760
Burner Specification	
Manufacturer	Power Flame Incorporated
Model No.	LNICM11-G-30 (Low NO _x burner)
Serial No.	030933075
Gas high fire rate (MBH)	37,800

Reference: Attachment E-1 – Power Flame Incorporated Typical Flue Product Emissions Data for Power Flame Burners

Emissions Point E-1: Natural Gas Fired Boiler PTE

Pollutant	lb per 10⁶ btu Input	lb/hour	tons/year
CO	0.037	1.40	6.13
NO _x	0.029	1.10	4.80
PM	0.0048	0.18	0.79
SO ₂	0.000525	0.02	0.09
VOC	0.003	0.11	0.50



DETAILED CALCULATIONS (CONTINUED):

Example calculation for CO emissions,

$$0.037 \text{ lb} / 10^6 \text{ btu} \times 37,800,000 \text{ btu/hour} = 1.40 \text{ lb/hour}$$

$$1.40 \text{ lb/hour} \times 8,760 \text{ hours/year} / 2,000 \text{ lb/ton} = 6.13 \text{ tons/year}$$

Emissions Point E-2: Natural Gas Fueled Rotary Dryer

Manufacturer	Louisville Dryer Company
Model No.	Co-current Direct Fired Dryer 60" diameter x 20' long
Serial No.	CD1095
Heat Requirement (MBH)	3,200
Natural gas heating value (btu/ft ³)	1,000
Fuel usage (ft ³ /hour)	4,020
Annual operating hours	8,760

Reference: Attachment E-2 – AP-42, Compilation of Air Pollutant Emission Factors, Section 1.4 Natural Gas Combustion, Tables 1.4-1. and 1.4-2

Emissions Point E-2: Natural Gas Fueled Rotary Dryer PTE

Pollutant	AP-42 Emission Factor (lb/10 ⁶ ft ³)	lb/hour	tons/year
CO	84	0.34	1.48
NO _x	100	0.40	1.76
PM	7.6	0.03	0.13
SO ₂	0.6	0.002	0.01
VOC	5.5	0.02	0.10

Example calculation for CO emissions,

$$84 \text{ lb} / 10^6 \text{ ft}^3 \times 4,020 \text{ ft}^3/\text{hour} = 0.34 \text{ lb/hour}$$

$$0.34 \text{ lb/hour} \times 8,760 \text{ hours/year} / 2,000 \text{ lb/ton} = 1.48 \text{ tons/year}$$



DETAILED CALCULATIONS (CONTINUED):

Emissions Point E-3: Evaporator

In order to calculate VOC/HAP/TAP emissions, the analytical results for ten (10) recent samples pulled from two (2) sample locations were reviewed. Outlet 201 samples represent untreated brine sampled from incoming trucks at the loading bays. Outlet 101 samples represent pretreated brine sampled after the carbon vessels prior to the brine impoundment. The parameters required under NPDES Permit WV0116408 were analyzed. The maximum values for VOC/HAP/TAP components from these analyses are listed in the following table:

Pollutant	No. of Samples	Sample Loc. (Outlet)	mg/l
Arsenic	10	101	0.102
Benzene	10	201	0.559
Bis(2-ethylhexyl)phthalate	10	101	0.0068
Cadmium	10	101	0.0141
Chromium	10	101	0.027
Cobalt	10	101	0.052
Decane	10	101	2.13*
Dimethyl phthalate	10	201	0.0087
Lead	10	101	0.0767
Nickel	10	101	0.201
Nitrated Hydrocarbons, Total	10	201	0.0254
Octadecane	10	101	0.65
Selenium	10	101	0.054
Pollutant	No. of Samples	Sample Loc. (Outlet)	pCi/l
Gross Alpha	10	201	14,920
Gross Beta	10	201	2,440
Radium-226	10	201	8,813
Radium-228	10	201	1,483

* One data point was removed from the data set based the value being more than 1.5 interquartile ranges above the third quartile (outlier by definition).



ATTACHMENT E – SUPPORTING CALCULATIONS

DETAILED CALCULATIONS (CONTINUED):

VOC/HAP/TAP concentrations were factored by 3 to account for potential variability.

Water Process Rate = 5,400 barrels/day = 35,772 liters/hour

Emissions Point E-3: Evaporator PTE

Pollutant	VOC/HAP/TAP	mg/l	lb/hour	tons/year
Arsenic	HAP	0.306	0.024	0.11
Benzene	VOC/HAP/TAP	1.677	0.132	0.58
Bis(2-ethylhexyl)phthalate	SVOC/HAP	0.020	0.002	0.01
Cadmium	HAP	0.042	0.003	0.01
Chromium	HAP	0.081	0.006	0.03
Cobalt	HAP	0.156	0.012	0.05
Decane	SVOC	6.39	0.503	2.20
Dimethyl phthalate	SVOC	0.026	0.002	0.01
Lead	HAP	0.230	0.018	0.08
Nickel	HAP	0.603	0.047	0.21
Nitrated Hydrocarbons, Total	SVOC	0.076	0.006	0.03
Octadecane	SVOC	1.95	0.153	0.67
Selenium	HAP	0.162	0.013	0.06
VOC			0.80	3.50
HAP			0.26	1.13
TAP			0.13	0.58
Pb			0.02	0.08
TOTAL VOC/HAP			0.92	4.04

Example calculation for Arsenic emissions,

$$(0.306 \text{ mg/l} \times 35,772 \text{ liters/hour}) / (10^6 \text{ mg/kg}) \times 2.2 \text{ lb/kg} = 0.024 \text{ lb/hour}$$

$$0.024 \text{ lb/hour} \times 8,760 \text{ hours/year} / 2,000 \text{ lb/ton} = 0.11 \text{ tons/year}$$



DETAILED CALCULATIONS (CONTINUED):

The air pollution control device was manufactured by TIGG Corporation. The device is an N 1800PDB vessel filled with 1,700 lbs. of TIGG 5CC coconut based carbon. A minimum efficiency of 80% was used to determine the controlled air emissions.

Emissions Point E-3: Evaporator PTE with Air Pollution Control Device

Pollutant	lb/hour	tons/year
VOC	0.16	0.70
HAP	0.05	0.23
TAP	0.03	0.12
Pb	0.004	0.02
TOTAL VOC/HAP	0.18	0.81



DETAILED CALCULATIONS (CONTINUED):

Emissions Point E-4: Oil Storage Tank

TANKS 4.0.9d	
Emissions Report - Detail Format	
Tank Identification and Physical Characteristics	
Identification	
User Identification:	01-TK-009 Fixed Roof
City:	Fairmont
State:	West Virginia
Company:	Fairmont Brine Processing
Type of Tank:	Vertical Fixed Roof Tank
Description:	Oil Storage Tank
Tank Dimensions	
Shell Height (ft):	25.50
Diameter (ft):	10.00
Liquid Height (ft) :	25.00
Avg. Liquid Height (ft):	12.50
Volume (gallons):	15,000.00
Turnovers:	6.00
Net Throughput(gal/yr):	90,000.00
Is Tank Heated (y/n):	N
Paint Characteristics	
Shell Color/Shade:	White/White
Shell Condition:	Good
Roof Color/Shade:	White/White
Roof Condition:	Good
Roof Characteristics	
Type:	Dome
Height (ft)	26.00
Radius (ft) (Dome Roof)	10.00
Breather Vent Settings	
Vacuum Settings (psig):	-0.03
Pressure Settings (psig)	0.03
Meteorological Data used in Emissions Calculations: Pittsburgh, Pennsylvania (Avg Atmospheric Pressure = 14.11 psia)	

TANKS 4.0.9d													
Emissions Report - Detail Format													
Liquid Contents of Storage Tank													
01-TK-009 Fixed Roof - Vertical Fixed Roof Tank													
Fairmont, West Virginia													
Mixture/Component	Months	Daily Liquid Surf Temperature (deg F)			Liquid Bulk Temp (deg F)	Vapor Pressure (psi a)			Vapor Mol. Weight	Liquid Mass Fract.	Vapor Mass Fract.	Mol. Weight	Basis for Vapor Pressure Calculations
Crude oil (RVP 5)	All	Avg.	Min.	Max.		Avg.	Min.	Max.					
		51.94	47.05	56.81	50.33	2.4501	2.2174	2.7022	50.0000			207.00	Option 4: RVP=5



DETAILED CALCULATIONS (CONTINUED):

Emissions Point E-4: Oil Storage Tank

TANKS 4.0.9d
Emissions Report - Detail Format
Detail Calculations (AP-42)

01-TK-009 Fixed Roof - Vertical Fixed Roof Tank
Fairmont, West Virginia

Annual Emission Calculations	
Standing Losses (lb):	348.6377
Vapor Space Volume (cu ft):	11,244.8073
Vapor Density (lb/cu ft):	0.0223
Vapor Space Expansion Factor:	0.0746
Vented Vapor Saturation Factor:	0.0510
Tank Vapor Space Volume:	
Vapor Space Volume (cu ft):	11,244.8073
Tank Diameter (ft):	10.0000
Vapor Space Outage (ft):	143.1733
Tank Shell Height (ft):	25.5000
Average Liquid Height (ft):	12.5000
Roof Outage (ft):	130.1733
Roof Outage (Dome Roof)	
Roof Outage (ft):	130.1733
Dome Radius (ft):	10.0000
Shell Radius (ft):	5.0000
Vapor Density	
Vapor Density (lb/cu ft):	0.0223
Vapor Molecular Weight (lb/lb-mole):	90.0000
Vapor Pressure at Daily Average Liquid Surface Temperature (psia):	2.4501
Daily Avg. Liquid Surface Temp. (deg. R):	511.8051
Daily Average Ambient Temp. (deg. F):	50.3063
Ideal Gas Constant R (psia cu ft / (lb-mol-deg R)):	10.731
Liquid Bulk Temperature (deg. R):	505.9963
Tank Paint Solar Absorptance (Shell):	0.1700
Tank Paint Solar Absorptance (Roof):	0.1700
Daily Total Solar Insulation Factor (Btu/sqft day):	1,202.9656
Vapor Space Expansion Factor	
Vapor Space Expansion Factor:	0.0746
Daily Vapor Temperature Range (deg. R):	19.5141
Daily Vapor Pressure Range (psia):	0.4848
Breather Vent Press. Setting Range (psia):	0.0600
Vapor Pressure at Daily Average Liquid Surface Temperature (psia):	2.4501
Vapor Pressure at Daily Minimum Liquid Surface Temperature (psia):	2.2174
Vapor Pressure at Daily Maximum Liquid Surface Temperature (psia):	2.7022
Daily Avg. Liquid Surface Temp. (deg R):	511.8051
Daily Min. Liquid Surface Temp. (deg R):	505.7266
Daily Max. Liquid Surface Temp. (deg R):	516.4836
Daily Ambient Temp. Range (deg. R):	19.1500
Vented Vapor Saturation Factor	
Vented Vapor Saturation Factor:	0.0510
Vapor Pressure at Daily Average Liquid Surface Temperature (psia):	2.4501
Vapor Space Outage (ft):	143.1733
Working Losses (lb):	
Working Losses (lb):	186.8833
Vapor Molecular Weight (lb/lb-mole):	90.0000
Vapor Pressure at Daily Average Liquid Surface Temperature (psia):	2.4501
Annual Net Throughput (gal/yr.):	90,000.0000
Annual Turnovers:	6.0000
Turnover Factor:	1.0000
Maximum Liquid Volume (gall):	15,000.0000
Maximum Liquid Height (ft):	25.0000
Tank Diameter (ft):	10.0000
Working Loss Product Factor:	0.7500
Total Losses (lb):	545.5209



DETAILED CALCULATIONS (CONTINUED):

Emissions Point E-4: Oil Storage Tank

**TANKS 4.0.9d
Emissions Report - Detail Format
Individual Tank Emission Totals**

Emissions Report for: Annual

**01-TK-009 Fixed Roof - Vertical Fixed Roof Tank
Fairmont, West Virginia**

Components	Losses(lbs)		
	Working Loss	Breathing Loss	Total Emissions
Crude oil (RVP 5)	196.88	348.64	545.52

Emissions Point E-6: Limo Silo

Lime Silo, 01-TK-015, will be equipped with a roof-mounted dust collector (01-F-015). When hydrated lime is pneumatically conveyed into 01-TK-015, the excess air will be vented through 01-F-015.

Dust Collector Specification	
Manufacturer	Bulk Conveyor Specialist, Inc.
Model No.	BV96-25 Bin Vent
Cloth Area	235 ft ²
Filter Fabric	16 oz. polyester felt, 4 ½” diameter x 8’ length
PM Emission (assumed)	0.01 gr/dscf (Assumes an inlet dust loading of 10 gr/dscf and 99.9% filtering efficiency.)



DETAILED CALCULATIONS (CONTINUED):

Estimated Lime Silo Operating Data	
Hydrated lime usage (lb/hr)	1,800
Annual operating hours	8,760
Annual usage (lb/year)	15,768,000
Lime added (lb/fill event)	44,000
Filling frequency (fill/year)	358
Filling duration (hours)	1.5 (based on an unloading rate of 500 lb/min)
Air flow rate (cfm)	700
Lime density (lb/ft ³)	25
Lime volume added (ft ³ /fill)	1,760
Safety factor (%)	20

Air volume through filter = 700 ft³/min x 60 min/hr x 1.5 hr/event + 1,760 ft³/event

Air volume through filter = 64,760 ft³/event

Emissions Point E-6: Limo Silo PTE

Maximum estimated hourly PM emissions =

$$64,760 \text{ ft}^3/\text{event} \times 0.01 \text{ gr/dscf} \times 1 \text{ lb}/7000 \text{ gr} \times 1 \text{ event}/1.5 \text{ hr} \times 1.20 = 0.07 \text{ lb/hr}$$

Maximum estimated annual PM emissions =

$$0.074 \text{ lb/hr} \times 1.5 \text{ hr/event} \times 358 \text{ event/yr} \times 1 \text{ ton}/2000 \text{ lb} = 0.02 \text{ tons/yr}$$



DETAILED CALCULATIONS (CONTINUED):

Emissions Point E-7: Natural Gas Fired Boiler

Boiler Specification	
Manufacturer	Cleaver-Brooks
Model No.	CB 800-300# Stm.
Serial No.	78837
Boiler output (MBH)	26,780
Horsepower	800
Maximum design steaming capacity (lb/hour)	27,600
Annual operating hours	8,760
Gas 100% firing rate (MBH)	33,057

Reference: Attachment E-7 – Cleaver-Brooks Boiler Expected Emission Data

Emissions Point E-7: Natural Gas Fired Boiler PTE

Pollutant	lb per 10⁶ btu Input	lb/hour	tons/year
CO	0.0375	1.24	5.43
NO _x	0.0700	2.31	10.14
PM	0.0056	0.19	0.81
SO ₂	0.0006	0.02	0.09
VOC	0.0036	0.12	0.52

Example calculation for CO emissions,

$$0.0375 \text{ lb} / 10^6 \text{ btu} \times 33,057,000 \text{ btu/hour} = 1.24 \text{ lb/hour}$$

$$1.24 \text{ lb/hour} \times 8,760 \text{ hours/year} / 2,000 \text{ lb/ton} = 5.43 \text{ tons/year}$$



ATTACHMENT E-1

Power Flame Incorporated Typical Flue Product Emissions Data
for Power Flame Burners

Power Flame Incorporated



Typical Flue Product Emissions Data for Power Flame Burners

Natural Gas

Carbon Monoxide - CO	.037 lb CO 10 ⁶ BTU input (50 PPM)
Sulfur Dioxide - SO ₂	(1.05) x (% Sulfur by weight in fuel) = lb SO ₂ per 10 ⁶ BTU Input
Particulate Matter	.0048 lb PM per 10 ⁶ BTU input
Hydrocarbons	.025 lb HC's per 10 ⁶ BTU input
CO ₂	9 % to 10%
Nitrogen Oxides - NO_x	
Standard Burner	.088 lb NO _x per 10 ⁶ BTU input (75 PPM)
Low NOx Burner	.029 lb NO _x per 10 ⁶ BTU input (25) PPM

Burning natural gas the VOC are estimated at 0.003 # per million BTU and SO_x are 0.0005 # per million

In instances where guarantees are required, please consult the factory with the specific application information.



ATTACHMENT E-2

AP-42, Compilation of Air Pollutant Emission Factors,
Section 1.4 Natural Gas Combustion, Tables 1.4-1. and 1.4-2.

Table 1.4-1. EMISSION FACTORS FOR NITROGEN OXIDES (NO_x) AND CARBON MONOXIDE (CO) FROM NATURAL GAS COMBUSTION^a

Combustor Type (MMBtu/hr Heat Input) [SCC]	NO _x ^b		CO	
	Emission Factor (lb/10 ⁶ scf)	Emission Factor Rating	Emission Factor (lb/10 ⁶ scf)	Emission Factor Rating
Large Wall-Fired Boilers (>100) [1-01-006-01, 1-02-006-01, 1-03-006-01]				
Uncontrolled (Pre-NSPS) ^c	280	A	84	B
Uncontrolled (Post-NSPS) ^c	190	A	84	B
Controlled - Low NO _x burners	140	A	84	B
Controlled - Flue gas recirculation	100	D	84	B
Small Boilers (<100) [1-01-006-02, 1-02-006-02, 1-03-006-02, 1-03-006-03]				
Uncontrolled	100	B	84	B
Controlled - Low NO _x burners	50	D	84	B
Controlled - Low NO _x burners/Flue gas recirculation	32	C	84	B
Tangential-Fired Boilers (All Sizes) [1-01-006-04]				
Uncontrolled	170	A	24	C
Controlled - Flue gas recirculation	76	D	98	D
Residential Furnaces (<0.3) [No SCC]				
Uncontrolled	94	B	40	B

^a Reference 11. Units are in pounds of pollutant per million standard cubic feet of natural gas fired. To convert from lb/10⁶ scf to kg/10⁶ m³, multiply by 16. Emission factors are based on an average natural gas higher heating value of 1,020 Btu/scf. To convert from lb/10⁶ scf to lb/MMBtu, divide by 1,020. The emission factors in this table may be converted to other natural gas heating values by multiplying the given emission factor by the ratio of the specified heating value to this average heating value. SCC = Source Classification Code. ND = no data. NA = not applicable.

^b Expressed as NO₂. For large and small wall fired boilers with SNCR control, apply a 24 percent reduction to the appropriate NO_x emission factor. For tangential-fired boilers with SNCR control, apply a 13 percent reduction to the appropriate NO_x emission factor.

^c NSPS=New Source Performance Standard as defined in 40 CFR 60 Subparts D and Db. Post-NSPS units are boilers with greater than 250 MMBtu/hr of heat input that commenced construction modification, or reconstruction after August 17, 1971, and units with heat input capacities between 100 and 250 MMBtu/hr that commenced construction modification, or reconstruction after June 19, 1984.

TABLE 1.4-2. EMISSION FACTORS FOR CRITERIA POLLUTANTS AND GREENHOUSE GASES FROM NATURAL GAS COMBUSTION^a

Pollutant	Emission Factor (lb/10 ⁶ scf)	Emission Factor Rating
CO ₂ ^b	120,000	A
Lead	0.0005	D
N ₂ O (Uncontrolled)	2.2	E
N ₂ O (Controlled-low-NO _x burner)	0.64	E
PM (Total) ^c	7.6	D
PM (Condensable) ^c	5.7	D
PM (Filterable) ^c	1.9	B
SO ₂ ^d	0.6	A
TOC	11	B
Methane	2.3	B
VOC	5.5	C

^a Reference 11. Units are in pounds of pollutant per million standard cubic feet of natural gas fired. Data are for all natural gas combustion sources. To convert from lb/10⁶ scf to kg/10⁶ m³, multiply by 16. To convert from lb/10⁶ scf to lb/MMBtu, divide by 1,020. The emission factors in this table may be converted to other natural gas heating values by multiplying the given emission factor by the ratio of the specified heating value to this average heating value. TOC = Total Organic Compounds. VOC = Volatile Organic Compounds.

^b Based on approximately 100% conversion of fuel carbon to CO₂. CO₂[lb/10⁶ scf] = (3.67) (CON) (C)(D), where CON = fractional conversion of fuel carbon to CO₂, C = carbon content of fuel by weight (0.76), and D = density of fuel, 4.2x10⁴ lb/10⁶ scf.

^c All PM (total, condensable, and filterable) is assumed to be less than 1.0 micrometer in diameter. Therefore, the PM emission factors presented here may be used to estimate PM₁₀, PM_{2.5} or PM₁ emissions. Total PM is the sum of the filterable PM and condensable PM. Condensable PM is the particulate matter collected using EPA Method 202 (or equivalent). Filterable PM is the particulate matter collected on, or prior to, the filter of an EPA Method 5 (or equivalent) sampling train.

^d Based on 100% conversion of fuel sulfur to SO₂. Assumes sulfur content is natural gas of 2,000 grains/10⁶ scf. The SO₂ emission factor in this table can be converted to other natural gas sulfur contents by multiplying the SO₂ emission factor by the ratio of the site-specific sulfur content (grains/10⁶ scf) to 2,000 grains/10⁶ scf.



ATTACHMENT E-7

Cleaver-Brooks Boiler Expected Emission Data

Cleaver-Brooks Boiler Expected Emission Data					
Date Author Customer City & State	Producing Steam Firing		Nat Gas		
	BACKGROUND INFORMATION			Boiler Model	CB(LE)
	02/11/16	Chris Mays	Operating Pressure (psig)	275.00	
	Nick Reuter	Virginia Beach, VA	Furnace Volume (cuft)	230.17	
			Furnace Heat Release (btu/hr/cu ft)	154,600	
			Heating Surface (sqft)	3500	
			Nox System	60	
Nat Gas		Firing Rate			
		25%	50%	75%	100%
Horsepower		200	400	600	800
Input, Btu/hr		8,398,000	16,477,000	24,739,000	33,057,000
CO	ppm	50	50	50	50
	lb/MMBtu	0.0375	0.0375	0.0375	0.0375
	lb/hr	0.31	0.62	0.93	1.24
	tpy	1.379	2.705	4.061	5.427
NOx	ppm	60	60	60	60
	lb/MMBtu	0.0700	0.0700	0.0700	0.0700
	lb/hr	0.59	1.15	1.73	2.31
	tpy	2.575	5.052	7.585	10.135
NO	ppm	51.0	51.0	51.0	51.0
	lb/MMBtu	0.060	0.060	0.060	0.060
	lb/hr	0.50	0.98	1.47	1.97
	tpy	2.06	4.04	6.07	8.11
NO ₂	ppm	9.0	9.0	9.0	9.0
	lb/MMBtu	0.011	0.011	0.011	0.011
	lb/hr	0.09	0.17	0.26	0.35
	tpy	0.51	1.01	1.52	2.03
SOx	ppm	0.34	0.34	0.34	0.34
	lb/MMBtu	0.0006	0.0006	0.0006	0.0006
	lb/hr	0.0049	0.0097	0.0146	0.0195
	tpy	0.022	0.042	0.064	0.085
VOCs (Non-Methane Only)	ppm	8	8	8	8
	lb/MMBtu	0.0036	0.0036	0.0036	0.0036
	lb/hr	0.030	0.059	0.088	0.118
	tpy	0.131	0.257	0.386	0.516
VOCs does not include any background VOC emissions.					
PM10 (Filterable)	ppm	N/A	N/A	N/A	N/A
	lb/MMBtu	0.0019	0.0019	0.0019	0.0019
	lb/hr	0.016	0.031	0.046	0.062
	tpy	0.069	0.134	0.202	0.270
PM10 (Condensable)	lb/MMBtu	0.0056	0.0056	0.0056	0.0056
	lb/hr	0.047	0.092	0.138	0.185
	tpy	0.206	0.403	0.606	0.809
PM2.5 (Filterable)	lb/MMBtu	0.0019	0.0019	0.0019	0.0019
	lb/hr	0.016	0.031	0.046	0.062
	tpy	0.069	0.134	0.202	0.270
PM2.5 (Condensable)	lb/MMBtu	0.0056	0.0056	0.0056	0.0056
	lb/hr	0.047	0.092	0.138	0.185
	tpy	0.206	0.403	0.606	0.809
Exhaust Data					
Temperature, F		426	438	449	461
Flow	ACFM	3,134	5,355	8,148	11,032
	SCFM (70 Degrees Fah.)	1,917	3,232	4,853	6,484
	DSCFM	1,733	2,870	4,309	5,758
	lb/hr	8,627	14,545	21,837	29,179
Velocity	ft/sec	16.63	28.41	43.23	58.52
	ft/min	998	1,705	2,594	3,511

Notes:

- 1) All ppm levels are corrected to dry at 3% oxygen.
- 2) Emission data based on actual boiler efficiency.
- 3) % H₂O , by volume in exhaust gas is **17.24** % O₂, by volume **2.47**
- 4) Water vapor in exhaust gas is **98.91** lbs/MMBtu of fuel fired
- 5) CO₂ produced is **116.31** lbs/MMBtu of fuel fired
- 6) Particulate is exclusive of any particulates in combustion air or other sources of residual particulates from material.
PM level indicated on this form is based on combustion air and fuel being clean and turndown up to 4:1.
- 7) Heat input is based on high heating value (HHV).
- 8.) Emission produced in tons per year (tpy) is based on 24 hours per day for 365 days = 8,760 hours per year
- 9.) Exhaust data is based on a clean and properly sealed boiler.
- 10.) Emission data is based on a burner turndown of 4 to 1, However the burner is capable of a higher turndown.

14) Fuel High Heating Value =

1000

Btu/FT³



May 17, 2016

Ms. Bev McKeone
NSR Program Manager
Division of Air Quality – Permitting Section
West Virginia Department of Environmental Protection
601 57th Street, SE
Charleston, West Virginia 25304

**Re: Permit Determination Form
Fairmont Brine Processing
Permit R13-2794**

Dear Ms. McKeone,

Enclosed for your review is West Virginia Department of Environmental Protection (WVDEP) Permit Determination Form for Fairmont Brine Processing, LLC's (FBP's) water treatment facility located at 168 AFR Drive, Fairmont, West Virginia 26554. This form is submitted in regard to Permit R13-2794. This request for determination includes the following modifications:

- Modify Source E-3: FBP plans to replace an existing heat exchanger, which will allow for an increase in plant capacity. This change will increase Emissions E-3.
- Add Source S-6: FBP plans to expand their pretreatment operations to include chemical precipitation, clarification, and effluent and sludge processing. This includes the installation of a lime silo (new Emissions E-6).
- Add Source S-7: FBP plans to install a second natural gas fueled boiler (new Emissions E-7) to provide a redundant heat source for the evaporation process.

If you have any questions, or require additional information, please contact me at (412) 680-6244 or via email at bkalt@fairmontbrine.com.

Sincerely,
Fairmont Brine Processing, LLC

A handwritten signature in blue ink that reads "B. Kalt".

Brian Kalt
President



WEST VIRGINIA
DEPARTMENT OF ENVIRONMENTAL PROTECTION
DIVISION OF AIR QUALITY
601 57th Street, SE
Charleston, WV 25304
Phone: (304) 926-0475
www.dep.wv.gov/daq

**PERMIT DETERMINATION FORM
(PDF)**

FOR AGENCY USE ONLY: PLANT I.D. # _____
PDF # _____ PERMIT WRITER: _____

1. NAME OF APPLICANT (AS REGISTERED WITH THE WV SECRETARY OF STATE'S OFFICE):

Fairmont Brine Processing

2. NAME OF FACILITY (IF DIFFERENT FROM ABOVE):

3. NORTH AMERICAN INDUSTRY CLASSIFICATION SYSTEM (NAICS) CODE:

2 1 3 1 1 2

4A. MAILING ADDRESS:

1501 Reedsdale Street, Suite 505
Pittsburgh, PA 15233

4B. PHYSICAL ADDRESS:

168 AFR Drive, Fairmont, WV 26554

5A. DIRECTIONS TO FACILITY (PLEASE PROVIDE MAP AS ATTACHMENT A):

From I-79, take exit 137. Merge onto WV-310 N toward Downtown/Fairmont. Stay straight to go onto Speedway Avenue/Old WV-73. Continue to follow Speedway Avenue. Turn left onto CR-7/22/Suncrest Boulevard. Turn slight left onto Montana Road/CR-7/24. Turn slight right onto CR-7/24. Turn slight right onto Hoult Road/Suncrest Boulevard. Turn left to stay on Hoult Road/Suncrest Boulevard. Turn slight left onto AFR Drive.

5B. NEAREST ROAD:

AFR Drive

5C. NEAREST CITY OR TOWN:

Fairmont

5D. COUNTY:

Marion

5E. UTM NORTHING (KM):

4,373.5

5F. UTM EASTING (KM):

575.2

5G. UTM ZONE:

17

6A. INDIVIDUAL TO CONTACT IF MORE INFORMATION IS REQUIRED:

Brian Kalt

6B. TITLE:

President

6C. TELEPHONE:

(412) 680-6244

6D. FAX:

6E. E-MAIL:

BKalt@fairmontbrine.com

7A. DAQ PLANT I.D. NO. (FOR AN EXISTING FACILITY ONLY):

0 4 9 - 0 0 1 3 0

7B. PLEASE LIST ALL CURRENT 45CSR13, 45CSR14, 45CSR19 AND/OR TITLE V (45CSR30) PERMIT NUMBERS ASSOCIATED WITH THIS PROCESS (FOR AN EXISTING FACILITY ONLY):

R13-2794

7C. IS THIS PDF BEING SUBMITTED AS THE RESULT OF AN ENFORCEMENT ACTION? IF YES, PLEASE LIST:

No

8A. TYPE OF EMISSION SOURCE (CHECK ONE):

- NEW SOURCE ADMINISTRATIVE UPDATE
 MODIFICATION OTHER (PLEASE EXPLAIN IN 11B)

8B. IF ADMINISTRATIVE UPDATE, DOES DAQ HAVE THE APPLICANT'S CONSENT TO UPDATE THE EXISTING PERMIT WITH THE INFORMATION CONTAINED HEREIN?

- YES NO

9. IS DEMOLITION OR PHYSICAL RENOVATION AT AN EXISTING FACILITY INVOLVED?

- YES NO

10A. DATE OF ANTICIPATED INSTALLATION OR CHANGE:

06 / 28 /2016 .

10B. DATE OF ANTICIPATED START-UP:

09 / 16 /2016 .

11A. PLEASE PROVIDE A DETAILED PROCESS FLOW DIAGRAM SHOWING EACH PROPOSED OR MODIFIED PROCESS EMISSION POINT AS ATTACHMENT B.

11B. PLEASE PROVIDE A DETAILED PROCESS DESCRIPTION AS ATTACHMENT C.

12. PLEASE PROVIDE MATERIAL SAFETY DATA SHEETS (MSDS) FOR ALL MATERIALS PROCESSED, USED OR PRODUCED AS ATTACHMENT D. FOR CHEMICAL PROCESSES, PLEASE PROVIDE A MSDS FOR EACH COMPOUND EMITTED TO AIR.

13A. REGULATED AIR POLLUTANT EMISSIONS:

⇒ **FOR A NEW FACILITY**, PLEASE PROVIDE PLANT WIDE EMISSIONS BASED ON THE POTENTIAL TO EMIT (PTE) FOR THE FOLLOWING AIR POLLUTANTS INCLUDING ALL PROCESSES.

⇒ **FOR AN EXISTING FACILITY**, PLEASE PROVIDE THE PROPOSED CHANGE IN EMISSIONS BASED ON THE PTE OF ALL PROCESS CHANGES FOR THE FOLLOWING AIR POLLUTANTS.

PTE FOR A GIVEN POLLUTANT IS TYPICALLY BEFORE AIR POLLUTION CONTROL DEVICES AND IS COLLECTED BASED ON THE MAXIMUM DESIGN CAPACITY OF PROCESS EQUIPMENT.

POLLUTANT	HOURLY PTE (LB/HR)	YEARLY PTE (TON/YR)
	Proposed Emissions (Change from Current Permit Limits)	(HOURLY PTE MULTIPLIED BY 8760 HR/YR) DIVIDED BY 2000 LB/TON Proposed Emissions (Change from Current Permit Limits)
PM	0.47 (+0.14)	1.76 (+0.32)
PM ₁₀	0.47 (+0.14)	1.76 (+0.32)
VOCs	0.48 (+0.03)	2.09 (+0.15)
CO	2.98 (-0.56)	13.03 (-2.47)
NO _x	3.81 (-0.29)	16.70 (-1.27)
SO ₂	0.04 (+0.02)	0.18 (+0.08)
Pb	0.004 (not included)	0.02 (not included)
HAPs (AGGREGATE AMOUNT)	0.05 (-0.10*)	0.23 (-0.43*)
TAPs (INDIVIDUALLY)*	0.03 (not included)	0.12 (not included)
OTHER (INDIVIDUALLY)*	NA	NA

* ATTACH ADDITIONAL PAGES AS NEEDED *Based on emission of VOCs and total HAPs from Evaporator (E-3) not to exceed 0.15 lb/hour.

13B. PLEASE PROVIDE ALL SUPPORTING CALCULATIONS AS ATTACHMENT E.

CALCULATE AN HOURLY AND YEARLY PTE OF EACH PROCESS EMISSION POINT (SHOWN IN YOUR DETAILED PROCESS FLOW DIAGRAM) FOR ALL AIR POLLUTANTS LISTED ABOVE INCLUDING INDIVIDUAL HAP'S (LISTED IN SECTION 112[b] OF THE 1990 CAAA), TAP'S (LISTED IN 45CSR27), AND OTHER AIR POLLUTANTS (E.G. POLLUTANTS LISTED IN TABLE 45-13A OF 45CSR13, MINERAL ACIDS PER 45CSR7, ETC.).

14. CERTIFICATION OF DATA

I, Brian Kalt (TYPE NAME) ATTEST THAT ALL THE REPRESENTATIONS CONTAINED IN THIS APPLICATION, OR APPENDED HERETO, ARE TRUE, ACCURATE, AND COMPLETE TO THE BEST OF MY KNOWLEDGE BASED ON INFORMATION AND BELIEF AFTER REASONABLE INQUIRY, AND THAT I AM A **RESPONSIBLE OFFICIAL**** (PRESIDENT, VICE PRESIDENT, SECRETARY OR TREASURER, GENERAL PARTNER OR SOLE PROPRIETOR) OF THE APPLICANT.

SIGNATURE OF RESPONSIBLE OFFICIAL: B. Kalt

TITLE: President, Fairmont Brine Processing DATE: 5 / 17 / 2016

**THE DEFINITION OF THE PHRASE 'RESPONSIBLE OFFICIAL' CAN BE FOUND AT 45CSR13, SECTION 2.23.

NOTE: PLEASE CHECK ENCLOSED ATTACHMENTS:
 ATTACHMENT A ATTACHMENT B ATTACHMENT C ATTACHMENT D ATTACHMENT E

RECORDS ON ALL CHANGES ARE REQUIRED TO BE KEPT AND MAINTAINED ON-SITE FOR TWO (2) YEARS.
 THE PERMIT DETERMINATION FORM WITH THE INSTRUCTIONS CAN BE FOUND ON DAQ'S PERMITTING SECTION WEB SITE:
www.dep.wv.gov/daq



ATTACHMENT A

SITE LOCATION MAP



ATTACHMENT A – SITE LOCATION MAP

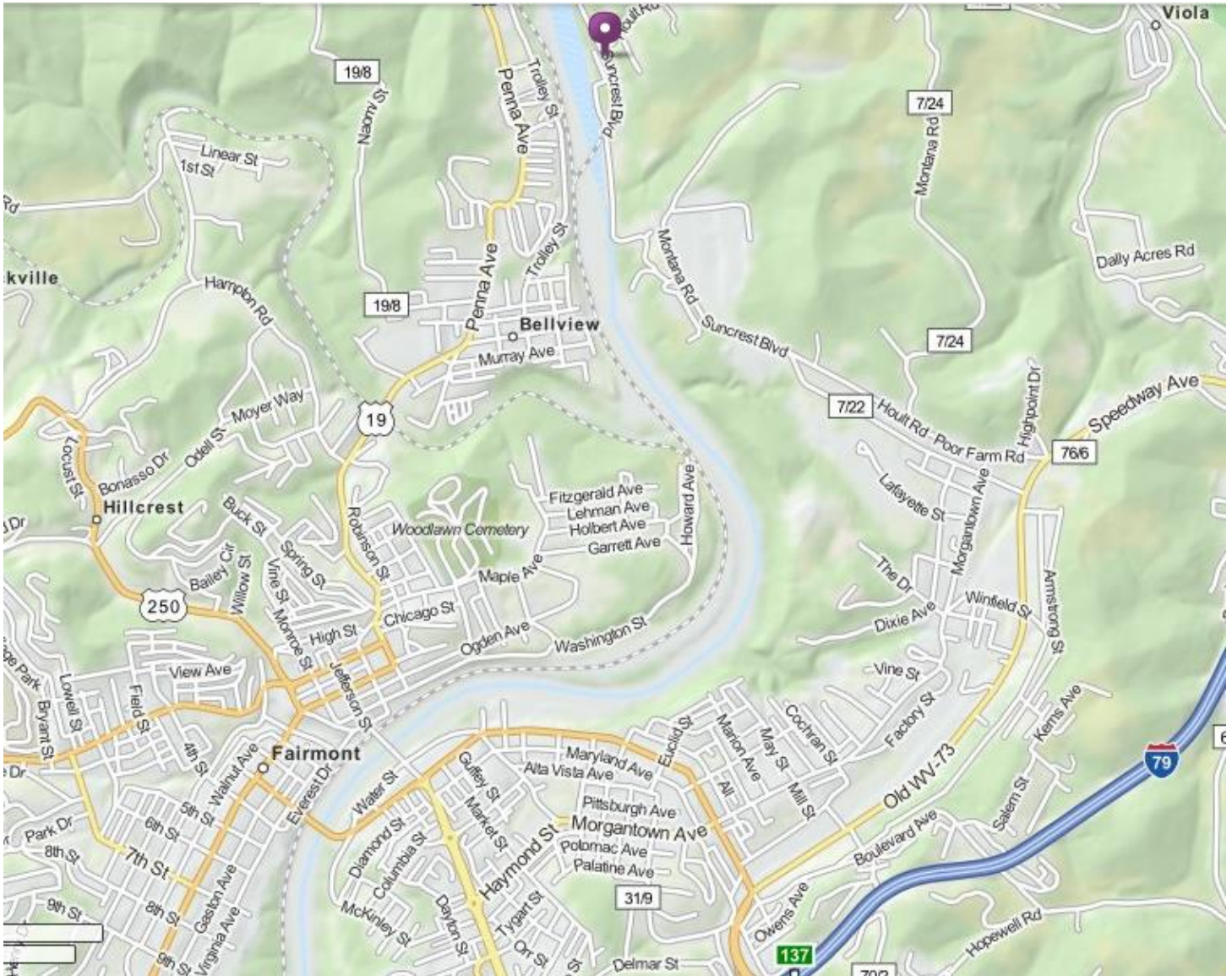



ATTACHMENT B

DETAILED PROCESS FLOW DIAGRAMS

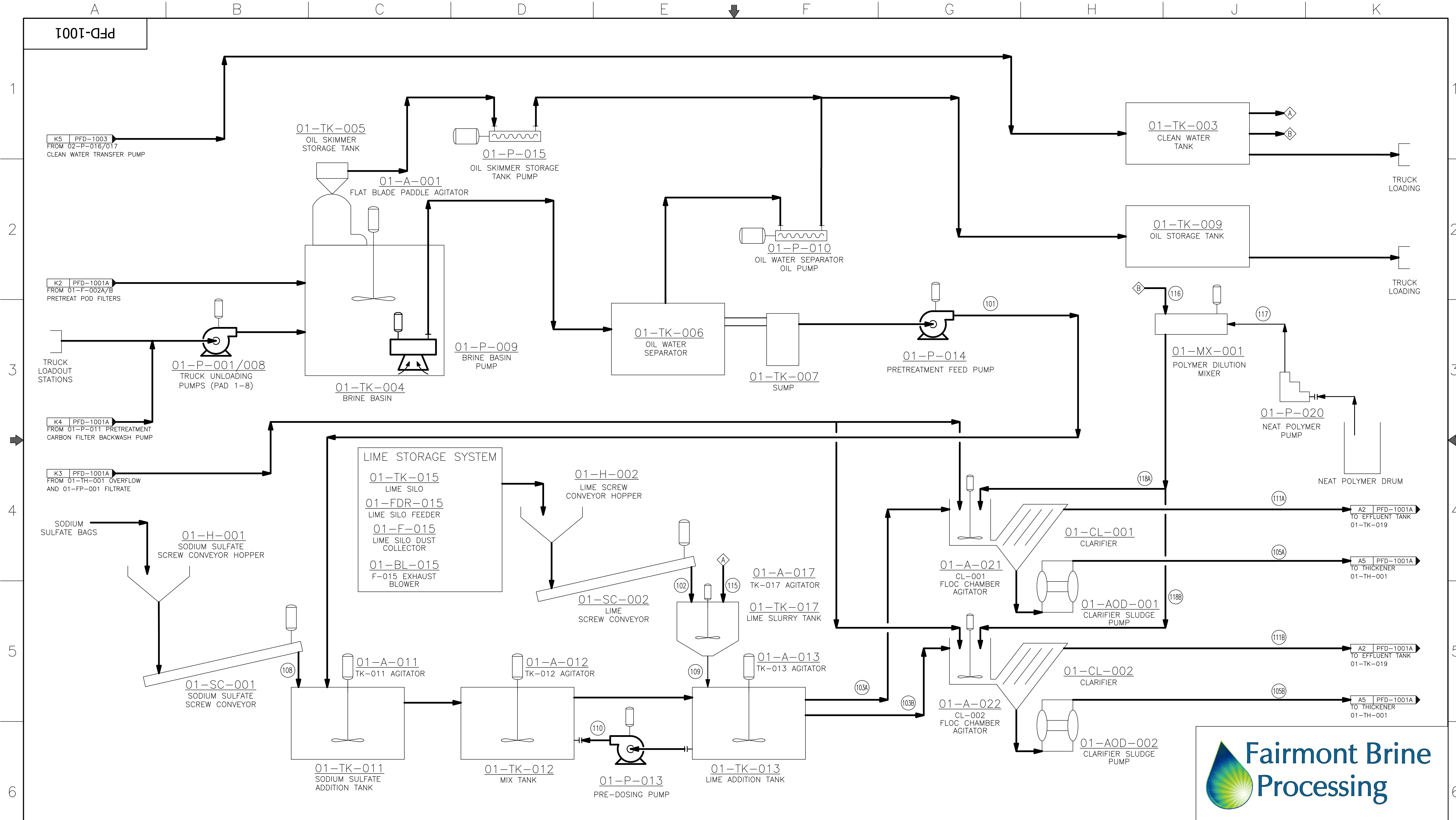

Venture Engineering & Construction

CONTRACT C12-1110-00 Pittsburgh, PA

FAIRMONT BRINE PROCESSING
FAIRMONT, WV
BRINE PROCESSING PLANT
BRINE PROCESSING
PRE-TREATMENT FLOW DIAGRAM

DRAWING NUMBER **PFD-1001** REV. **B**

RELEASED FOR REVIEW AND COMMENT

THE DESIGN AND PRINT ARE THE INTELLECTUAL PROPERTY OF VENTURE ENGINEERING & CONSTRUCTION, INC. IT MUST BE RETURNED WITH THE QUOTATION OR UPON DELIVERY OF MATERIAL AND EQUIPMENT AND MUST NOT BE USED IN MANUFACTURING FOR OTHERS EXCEPT BY PERMISSION OF OWNERS.



REVISION						REVISION						DESIGNED/DWN BY	PC	DATE	10/16/15	
NO.	REVISION	DWN	CHK	ENG	PM	DATE	NO.	REVISION	DWN	CHK	ENG					PM
B	REVISED FOR PRETREAT EXPANSION								JSH	RA	PEV		4/11/16			
A	FOR REVIEW & COMMENT								PC	LK	PEV					

SCALE NONE

PFD-1001A

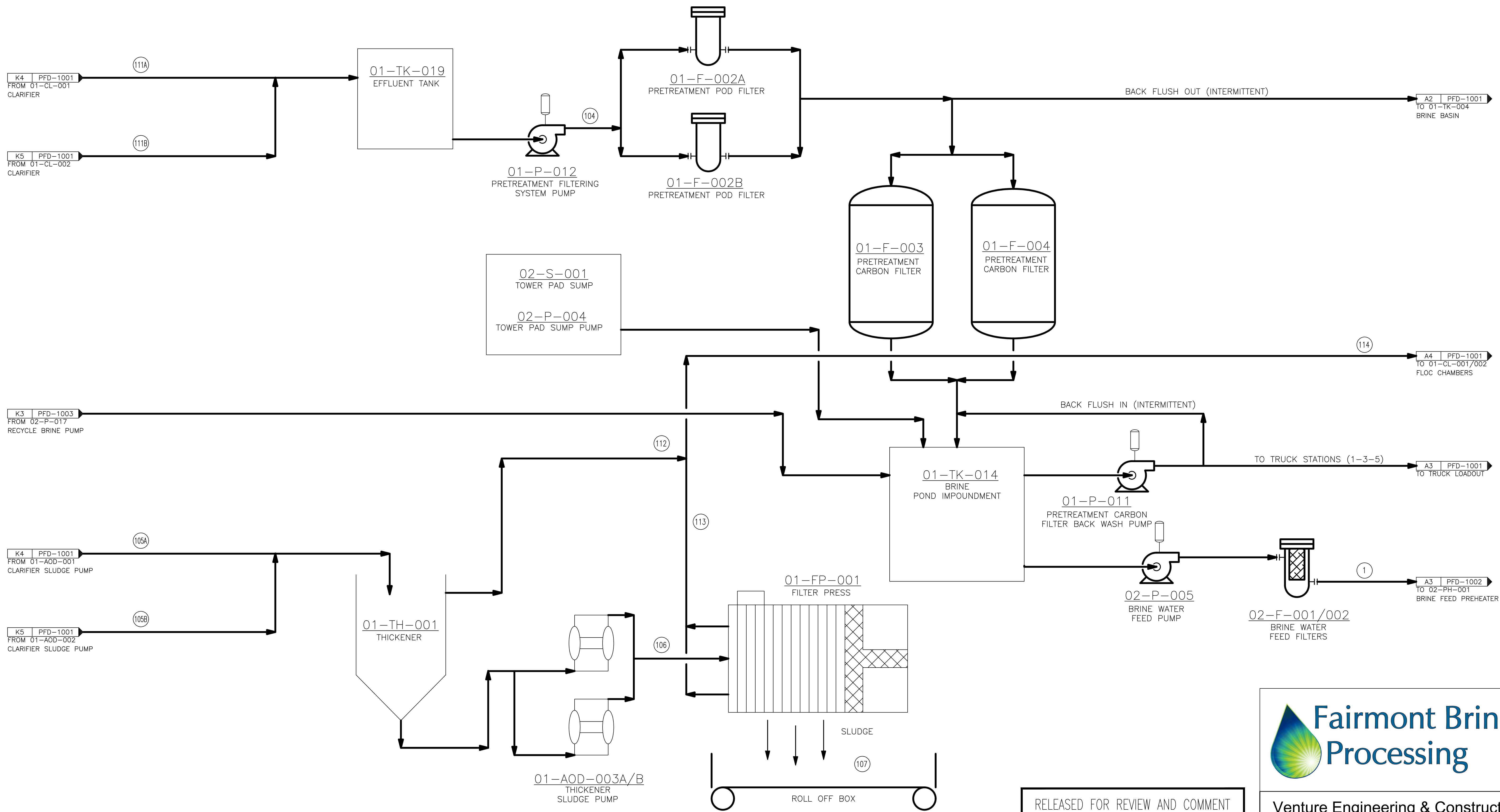

RELEASED FOR REVIEW AND COMMENT



Venture Engineering & Construction

CONTRACT C12-1110-00 Pittsburgh, PA

FAIRMONT BRINE PROCESSING
FAIRMONT, WV
BRINE PROCESSING PLANT
BRINE PROCESSING
FLOW DIAGRAM

DRAWING NUMBER PFD-1001A REV. B

NO.	REVISION	DWN	CHK	ENG	PM	DATE	NO.	REVISION	DWN	CHK	ENG	PM	DATE	DESIGNED/DWN BY	PC	DATE	10/16/15
B	REVISED FOR PRETREATMENT EXPANSION								JSH	RA	PEV		4/11/16				
A	FOR REVIEW & COMMENT								PC	LK	PEV						

THE DESIGN AND PRINT ARE THE INTELLECTUAL PROPERTY OF VENTURE ENGINEERING & CONSTRUCTION, INC. IT MUST BE RETURNED WITH THE QUOTATION OR UPON DELIVERY OF MATERIAL AND EQUIPMENT AND MUST NOT BE USED IN MANUFACTURING FOR OTHERS EXCEPT BY PERMISSION OF OWNERS.

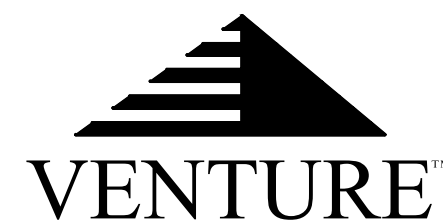

VENTURE

PFD-1001MB

Fairmont Brine Processing PFD-1001/1A Mass Balance	
Project No.:	C15-1205-04
Project Name:	FBP - D&I - Pretreatment Expansion
Rev.:	B
Rev. Date:	4/11/2016

Stream No.	1	101	102	103A/B	104	105A/B (BATCH)	106 (BATCH)	107 (BATCH)	108	109	110	111A/B	112	113	114	115	116	117	118A/B
ChemCAD Ref.	54	-	-	-	-	-	-	-	-	-	-	-	-	-	-	-	-	-	-
Stream Name	Feed to 02-PH-001	Pretreatment Feed	Dry Hydrated Lime	Feed to Clarifier	Treated Brine	Clarifier Sludge	Thickner Sludge	Pressed Sludge	Dry Sodium Sulfate	Lime Slurry	Reactor Tank Pre-Dosing	Clarifier Effluent	Thickener Overflow	Filter Press Filtrate	Overflow & Filtrate Return	CW to Lime Slurry	CW to Polymer Dilution	Neat Polymer	Diluted Polymer to CL
Temp F	50.82	50	50	50	50	50	50	50	50	55	55	55	55	55	55	55	55	55	55
Pres psia	185.00	45	15	15	56	35	45	15	15	15	27	15	15	30	15	60	60	-	60
Enth MMBtu/hr	-552.69	-	-	-	-	-	-	-	-	-	-	-	-	-	-	-	-	-	-
Vapor mole frac.	0.00	-	-	-	-	-	-	-	-	-	-	-	-	-	-	-	-	-	-
pH value	7.03	4.5-6.5	N/A	11	11	11	11	11	4.5-6.5	12	11	11	11	11	11	7	7	-	-
Ionic str. Molal	4.37	-	-	-	-	-	-	-	-	-	-	-	-	-	-	-	-	-	-
Total lbmol/hr	4582.69	-	-	-	-	-	-	-	-	-	-	-	-	-	-	-	-	-	-
Total lb/hr	89275.00	234,683	1,800	122,118	240,192	3,037	6,074	3,037	552	9,000	86,371	119,081	0	3,037	3,037	7,200	477	1.11E-04	477
Total std L gpm	156.75	400	N/A	200	400	4.60	9.19	3.68	-	15	150	195	0	5	5	14	1	0	15
Total std V scfh	1739031.38	-	-	-	-	-	-	-	-	-	-	-	-	-	-	-	-	-	-
Liquid Flow in lb/hr																			
Water	73475.81	199,680	0	103,440	203,251	1,814	3,629	1,037	0	7,200	77,580	101,626	0	2,592	2,592	7,200	477	0	477
OH-	0.00	-	0	64	126	1	2.25	0.64	0	826	48	63	0.00	1.61	2	0	0	0	0
Cl-	9748.20	20,092	0	10,046	19,740	176	352	101	0	0	7,535	9,870	0	252	252	0	0	0	0
Ca++	1836.74	3,405	0	2,189	4,302	38	77	22	0	974	1,642	2,151	0	55	55	0	0	0	0
SO4--	-	0	0	43	84	1	1	0	0	0	32	42	0	1	1	0	0	0	0
Na+	4214.24	10,014	0	5,096	10,014	89	179	51	0	0	3,822	5,007	0	128	128	0	0	0	0
Sr++	-	802	0	321	630	6	11	3	0	0	241	315	0	8	8	0	0	0	0
Ba++	-	160	0	0	0	0	0	0	0	0	0	0	0	0	0	0	0	0	0
Mg++	-	500	0	8	15	0	0	0	0	0	6	7	0	0	0	0	0	0	0
Fe++	-	30	0	0	0	0	0	0	0	0	0	0	0	0	0	0	0	0	0
Total lb/hr	89275.00	234,683	0	121,207	238,162	2,126	4,252	1,215	0	9,000	90,905	119,081	0	3,037	3,037	7,200	477	0	477
Solids Flow in lb/hr																			
Na2SO4	-	0	0	0	0	0	0	0	552	0	0	0	0	0	0	0	0	0	0
BaSO4	-	0	0	136	0	136	272	272	0	0	51	0	0	0	0	0	0	0	0
SrSO4	-	0	0	168	0	168	336	336	0	0	63	0	0	0	0	0	0	0	0
Ca(OH)2	-	0	1,800	0	0	0	0	0	0	0	0	0	0	0	0	0	0	0	0
Mg(OH)2	-	0	0	583	0	583	1,166	1,166	0	0	219	0	0	0	0	0	0	0	0
Fe(OH)2	-	0	0	24	0	24	48	48	0	0	9	0	0	0	0	0	0	0	0
Total lb/hr	-	0	1,800	911	0	911	1,822	1,822	552	0	342	0	0	0	0	0	0	0	0

Assumptions:
 Basis for all elemental values come from the analytical results from treatability report unless otherwise noted.
 Raw Brine flow: 400 gpm
 Ca: 17,000ppm
 Cl: 100,000ppm
 Na: 50,000ppm
 Sr: 4,000ppm (assumed 20% removal as SrSO4)
 Ba: 800ppm (assumed 100% removal as BaSO4)
 Mg: 2,500ppm (assumed 97% removal as Mg(OH)2 - based on removal efficiency required to meet ASTM specification for CaCl2 product)
 Fe: 150ppm (assumed 100% removal as Fe(OH)2)
 OH: Based only on the addition of lime.
 Hydrated Lime: 30lb/min (dosing recommendation from treatability study)
 Sodium Sulfate: 9.2lb/min (dosing recommendation from treatability study)
 Stream 105 is based on 30% solids sludge (estimate) and is a batch process.
 Stream 106 is based on 30% solids sludge (estimate) and is a batch process.
 Stream 107 is based on 60% solids sludge (from Evoqua filter press report) and is a batch process.
 Constituents not listed are trace elements that do not make a significant impact on mass flow calculations.
 100% efficiency of the sulfate and hydroxide precipitation.

RELEASED FOR REVIEW AND COMMENT



Venture Engineering & Construction
 CONTRACT C12-1110-00 Pittsburgh, PA

FAIRMONT BRINE PROCESSING
 FAIRMONT, WV
 BRINE PROCESSING PLANT
 BRINE PROCESSING
 PRE-TREATMENT MASS BALANCE

DRAWING NUMBER **PFD-1001MB** REV. **B**

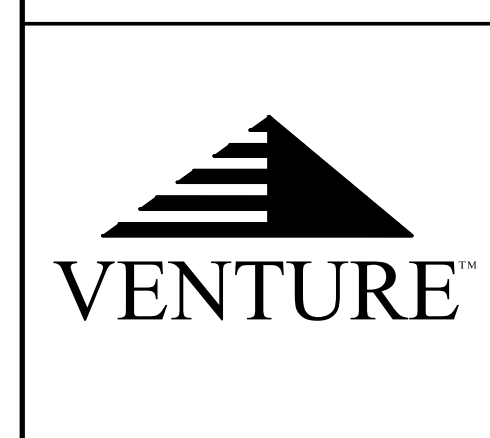

NO.	REVISION	DWN	CHK	ENG	PM	DATE	NO.	REVISION	DWN	CHK	ENG	PM	DATE	DESIGNED/DWN BY	LK/PC	DATE	10/23/15
														CHECKED BY	-	DATE	-
														CHECKED BY ENGR	-	DATE	-
														APPROVED BY PM	-	DATE	-
														APPROVED BY MANAGER OF ENGR	-	DATE	-
							B	REVISED FOR PRETREAT EXPANSION	JSH	RA	PEV		4/11/16				
							A	FOR REVIEW & COMMENT	PC	LK	PEV						
														SCALE	NONE		

THE DESIGN AND PRINT ARE THE INTELLECTUAL PROPERTY OF VENTURE ENGINEERING & CONSTRUCTION, INC. IT MUST BE RETURNED WITH THE QUOTATION OR UPON DELIVERY OF MATERIAL AND EQUIPMENT AND MUST NOT BE USED IN MANUFACTURING FOR OTHERS EXCEPT BY PERMISSION OF OWNERS.

2001-D11

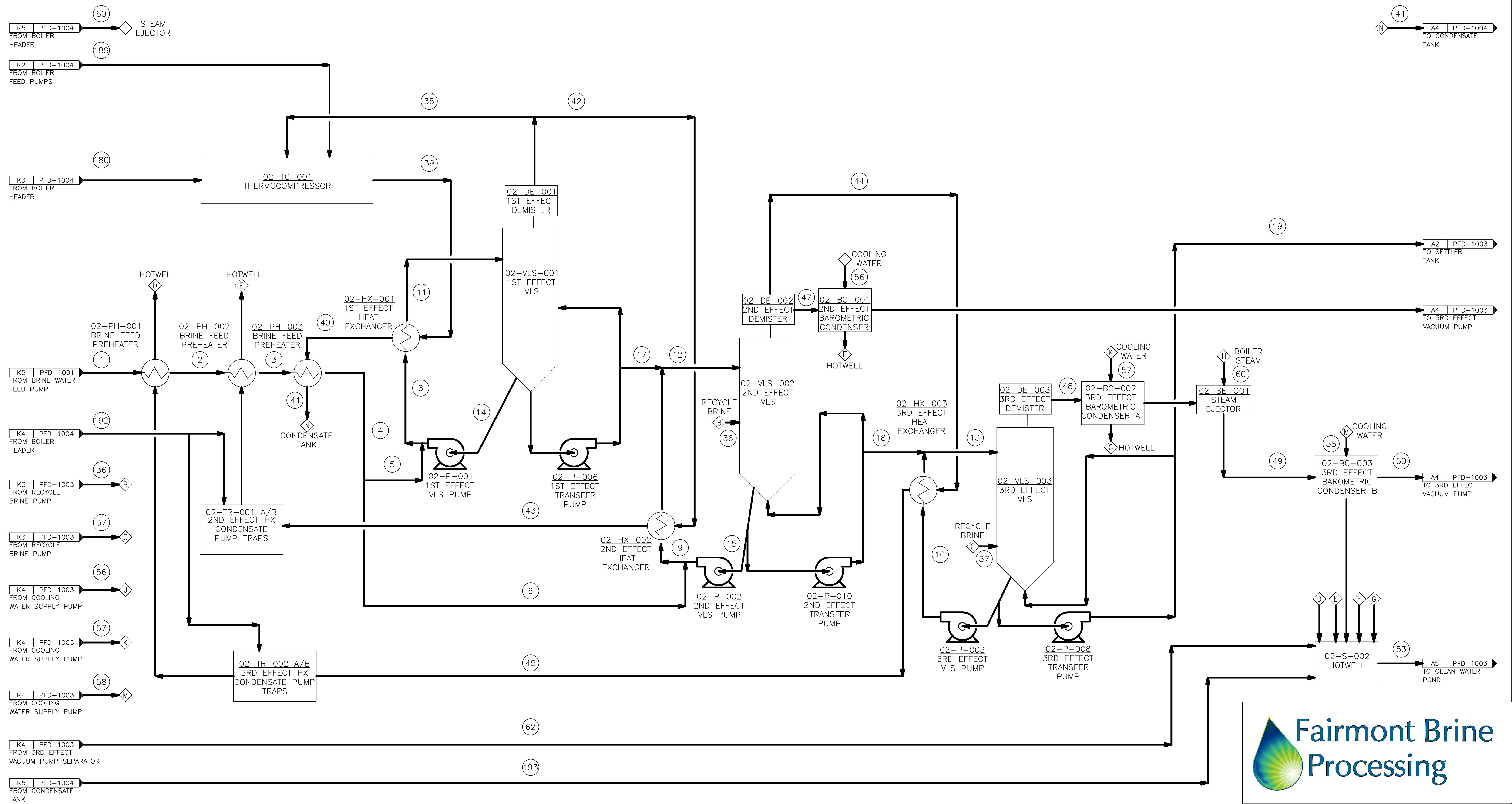

RELEASED FOR REVIEW AND COMMENT



Venture Engineering & Construction
 CONTRACT C12-1110-00 Pittsburgh, PA

FAIRMONT BRINE PROCESSING
 FAIRMONT, WV
 BRINE PROCESSING PLANT
 BRINE PROCESSING
 FLOW DIAGRAM

DRAWING NUMBER **PFD-1002** REV. **C**

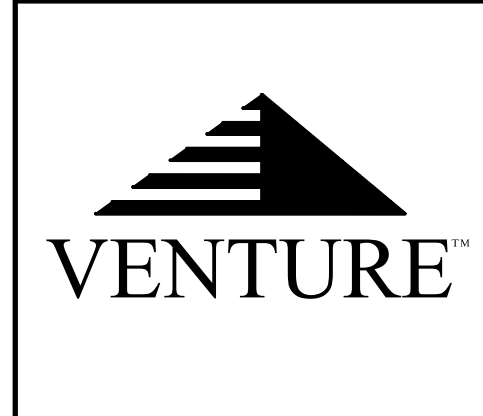

NO.	REVISION	DWN	CHK	ENG	PM	DATE	NO.	REVISION	DWN	CHK	ENG	PM	DATE	DESIGNED/DWN BY	RC	DATE	08/14/14
														CHECKED BY	RK	DATE	08/14/14
														CHECKED BY ENGR	RK	DATE	08/14/14
														APPROVED BY PM	PEV	DATE	08/14/14
														APPROVED BY MANAGER OF ENGR	KZ	DATE	08/14/14
														SCALE	-		
							C	REVISED FOR C15120500 PROJECTS	JSH	LK	PEV		04/11/16				
							B	REVISED FOR C15120500 PROJECTS	JSH	LK	PEV		03/10/16				
							A	FOR REVIEW & COMMENT	RC	RK	KZ	PEV	08/14/14				

THE DESIGN AND PRINT ARE THE INTELLECTUAL PROPERTY OF VENTURE ENGINEERING & CONSTRUCTION, INC. IT MUST BE RETURNED WITH THE QUOTATION OR UPON DELIVERY OF MATERIAL AND EQUIPMENT AND MUST NOT BE USED IN MANUFACTURING FOR OTHERS EXCEPT BY PERMISSION OF OWNERS.

PFD-1003

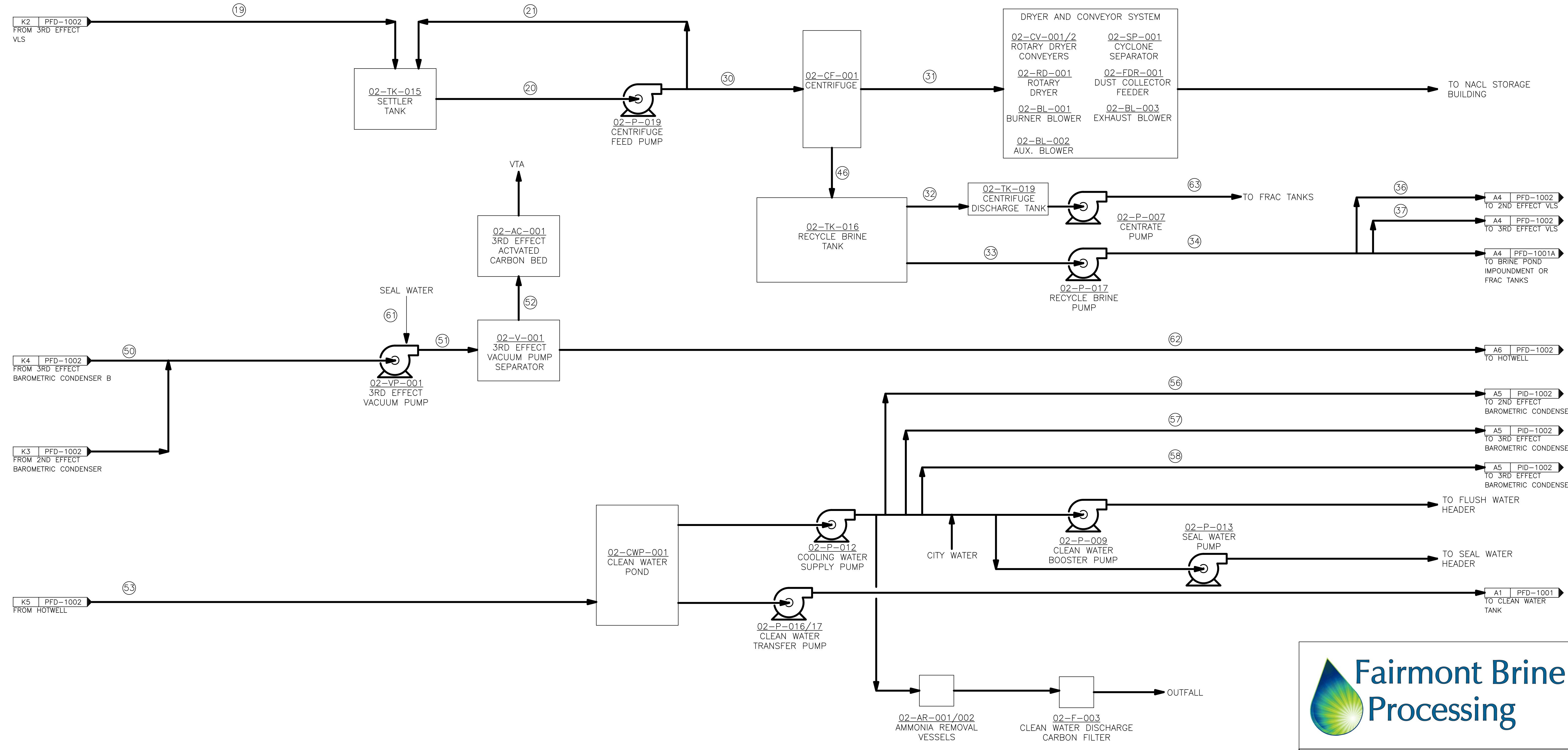

RELEASED FOR REVIEW AND COMMENT



Venture Engineering & Construction
 CONTRACT C12-1110-00 Pittsburgh, PA

FAIRMONT BRINE PROCESSING
 FAIRMONT, WV
 BRINE PROCESSING PLANT
 BRINE PROCESSING
 FLOW DIAGRAM

DRAWING NUMBER **PFD-1003** REV. **C**



NO.	REVISION	DWN	CHK	ENG	PM	DATE	NO.	REVISION	DWN	CHK	ENG	PM	DATE	DESIGNED/DWN BY	RC	DATE	08/14/14
														CHECKED BY	RK	DATE	08/14/14
														CHECKED BY ENGR	RK	DATE	08/14/14
														APPROVED BY PM	PEV	DATE	08/14/14
														APPROVED BY MANAGER OF ENGR	KZ	DATE	08/14/14
														APPROVED BY	PEV	DATE	04/11/16
														APPROVED BY	PEV	DATE	03/10/16
														APPROVED BY	PEV	DATE	08/14/14
														SCALE	-		

THE DESIGN AND PRINT ARE THE INTELLECTUAL PROPERTY OF VENTURE ENGINEERING & CONSTRUCTION, INC. IT MUST BE RETURNED WITH THE QUOTATION OR UPON DELIVERY OF MATERIAL AND EQUIPMENT AND MUST NOT BE USED IN MANUFACTURING FOR OTHERS EXCEPT BY PERMISSION OF OWNERS.

PFD-1003MB

Fairmont Brine Processing PFD-1003 Mass Balance	
Project No.:	C15-1205-00
Project Name:	FBP - Debottlenecking and Improvements
Rev.:	D
Rev. Date:	4/11/2016

Stream No.	19	20	21	30	31	32	33	34	36	37	46	50	51	52	53	56	57	58	61	62	63	
ChemCad Ref. No.	36	64	66	67	72	70	71	16	49	50	68	83	85	87	-	41	53	78	82	86	74	
Stream Name	02-VLS-003 Transfer/Feed to 02-TK-015	02-TK-015 Discharge/Feed to 02-P-019	Recirculation to 02-TK-015	Feed to 02-CF- 001	Feed to 02-RD- 001	02-TK-016 Discharge/ Overflow to 02- TK-019	02-TK-016 Discharge/Feed to 02-P-017	02-P-017 Discharge	Recycle to 02-VLS- 002	Recycle to 02-VLS- 003	02-CF-001 to 02- TK-016	02-BC-003 to 02- VP-001	02-VP-001 to 02-V- 001	02-V-001 to 02-AC- 001	Hotwell Discharge	02-P-012 to 02-BC- 001	02-P-012 to 02-BC- 002	02-P-012 to 02-BC- 003	Seal Water to 02- VP-001	02-V-001 to Hotwell	To Frac Tanks or Brine Impoundment	
Temp F	149.29	120.00	120.03	120.03	120.03	120.03	120.03	120.16	120.16	120.16	120.03	122.17	90.18	90.93	92.00	90.00	90.00	90.00	90.00	90.00	90.93	120.17
Pres psia	65.00	14.70	25.00	25.00	25.00	14.70	14.70	45.00	45.00	45.00	25.00	14.70	16.70	16.70	14.70	73.60	73.60	73.60	15.00	16.70	16.70	45.00
Enth MMBtu/hr	-289.57	-1150.00	-859.49	-290.49	-45.01	-83.28	-162.20	-162.20	-26.86	-135.34	-245.48	-0.04	-37.49	-0.01	-	-5957.90	-5957.90	-85.11	-37.45	-37.48	-83.27	
Vapor mole frac.	0.00	0.00	0.00	0.00	0.00	0.00	0.00	0.00	0.00	0.00	0.00	1.00	0.00	1.00	0.00	0.00	0.00	0.00	0.00	0.00	0.00	
pH value	7.13	7.35	7.35	7.35	7.35	7.35	7.35	7.35	7.35	7.35	7.35	0.00	6.88	0.00	6.88	6.88	6.88	6.88	6.88	6.88	6.88	7.35
Ionic str. Molal	18.46	18.48	18.48	18.48	18.48	18.48	18.48	18.48	18.49	18.49	18.48	0.00	0.00	0.00	0.00	0.00	0.00	0.00	0.00	0.00	0.00	
Total lbmol/hr	2300.25	9100.27	6801.50	2298.78	290.18	681.38	1327.21	1327.21	219.77	1107.38	2008.59	2.97	308.30	2.72	-	48575.25	48575.25	693.93	305.33	305.58	681.38	
Total lb/hr	58599.45	231980.52	173381.08	58599.46	12908.12	15500.00	30191.34	30191.34	5000.00	25193.83	45691.34	81.66	5582.18	77.11	1828778.91	875083.00	875083.00	12501.19	5500.52	5505.07	15500.00	
Total std L gpm	78.96	312.46	233.53	78.93	14.20	21.98	42.82	42.82	7.09	35.72	64.80	0.46	11.46	0.45	-	1750.00	1750.00	25.00	11.00	11.01	21.98	
Total std V scfh	872897.00	3453357.50	2581022.75	872336.00	110117.79	258569.41	503648.75	503648.75	83399.02	420228.16	762218.19	1127.66	116993.91	1032.66	-	18433268.00	18433268.00	263332.41	115866.26	115961.26	258569.41	
Flow rates in lb/hr																						
Water	28634.67	113264.80	84653.54	28611.27	1530.12	9186.81	17894.33	17894.33	2962.54	14927.57	27081.14	6.55	5507.08	2.11	1828755.64	875083.00	875083.00	12501.19	5500.52	5504.96	9186.81	
Sodium Chloride	10282.77	40880.23	30553.51	10326.50	10326.50	0.00	0.00	0.00	0.00	0.00	0.00	0.00	0.00	0.00	0.00	0.00	0.00	0.00	0.00	0.00	0.00	
Calcium Chloride	0.00	0.00	0.00	0.00	0.00	0.00	0.00	0.00	0.00	0.00	0.00	0.00	0.00	0.00	0.00	0.00	0.00	0.00	0.00	0.00	0.00	
Oxygen	0.00	0.00	0.00	0.00	0.00	0.00	0.00	0.00	0.00	0.00	0.00	16.46	16.46	16.42	5.14	0.00	0.00	0.00	0.00	0.00	0.00	
Nitrogen	0.00	0.00	0.00	0.00	0.00	0.00	0.00	0.00	0.00	0.00	0.00	58.64	58.64	58.57	17.87	0.00	0.00	0.00	0.00	0.00	0.00	
H+	0.00	0.00	0.00	0.00	0.00	0.00	0.00	0.00	0.00	0.00	0.00	0.00	0.00	0.00	0.00	0.00	0.00	0.00	0.00	0.00	0.00	
OH-	0.00	0.00	0.00	0.00	0.00	0.00	0.00	0.00	0.00	0.00	0.00	0.00	0.00	0.00	0.00	0.00	0.00	0.00	0.00	0.00	0.00	
Cl-	12546.02	49621.00	37086.58	12534.55	670.34	4024.73	7839.48	7839.48	1298.90	6544.84	11864.20	0.00	0.00	0.00	0.00	0.00	0.00	0.00	0.00	0.00	4024.73	
Ca++	6979.85	27678.17	20686.53	6991.65	373.91	2244.95	4372.78	4372.78	724.56	3650.90	6617.74	0.00	0.00	0.00	0.00	0.00	0.00	0.00	0.00	0.00	2244.95	
Na+	156.15	536.33	400.92	135.50	7.25	43.51	84.75	84.75	14.00	70.52	128.26	0.00	0.00	0.00	0.00	0.00	0.00	0.00	0.00	0.00	43.51	

Notes:
 Based on ChemCAD simulation entitled FBP - C15120500 - 160411.ccb
 PFD Stream 53 is the summation of ChemCAD Streams 29 (PH-1 to HW), 18 (PH-2 to HW), 45 (BC-1 to HW), 80 (BC-2 to HW), 81 (BC-3 to HW), and 86 (V-1 to HW) plus PFD Streams 192 (Boiler steam to Condensate Pump Traps) and 193 (Condensate Tank to HW).
 Flow rates within +/-0.1% accuracy based on allowable tolerances in ChemCAD simulation.

RELEASED FOR REVIEW AND COMMENT



Venture Engineering & Construction
 CONTRACT C12-1110-00 Pittsburgh, PA

FAIRMONT BRINE PROCESSING
 FAIRMONT, WV
 BRINE PROCESSING PLANT
 BRINE PROCESSING
 MASS BALANCE

DRAWING NUMBER: PFD-1003MB
 REV. D

THE DESIGN AND PRINT ARE THE
 INTELLECTUAL PROPERTY OF
 VENTURE ENGINEERING &
 CONSTRUCTION, INC. IT MUST BE
 RETURNED WITH THE QUOTATION
 OR UPON DELIVERY OF MATERIAL
 AND EQUIPMENT AND MUST NOT
 BE USED IN MANUFACTURING
 FOR OTHERS EXCEPT BY
 PERMISSION OF OWNERS.

NO.	REVISION	DWN	CHK	ENG	PM	DATE	NO.	REVISION	DWN	CHK	ENG	PM	DATE	DESIGNED/DWN BY	LK/JSH	DATE	03/14/16	CHECKED BY	-	DATE	-	APPROVED BY PM	-	DATE	-	APPROVED BY MANAGER OF ENGR	-	DATE	-
D	REVISED FOR C15120500 PROJECTS								JSH	LK	PEV		04/11/16																
C	FOR REVIEW & COMMENT								JSH	LK	PEV		03/14/16																

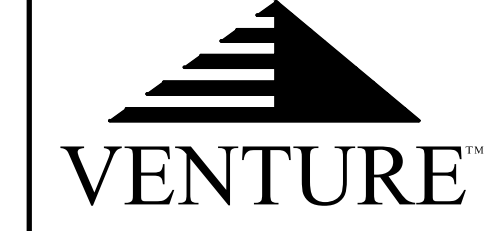

PFD-1004

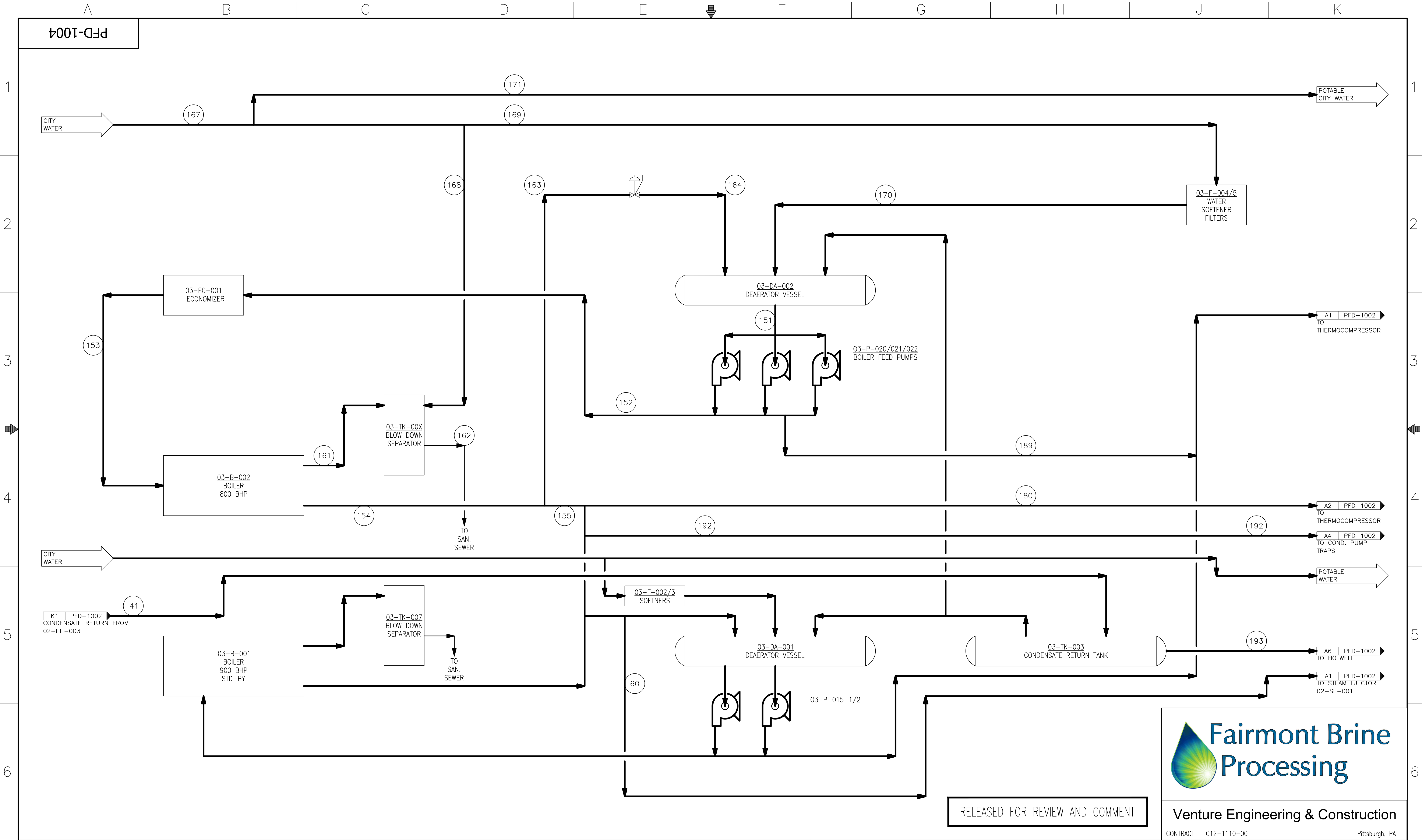

RELEASED FOR REVIEW AND COMMENT



Venture Engineering & Construction
 CONTRACT C12-1110-00 Pittsburgh, PA

FAIRMONT BRINE PROCESSING
 FAIRMONT, WV
 BRINE PROCESSING PLANT
 WATER & STEAM
 FLOW DIAGRAM

DRAWING NUMBER **PFD-1004** REV. **D**



NO.	REVISION	DWN	CHK	ENG	PM	DATE	NO.	REVISION	DWN	CHK	ENG	PM	DATE	DESIGNED/DWN BY	DATE	CHECKED BY	DATE	CHECKED BY ENGR	DATE	APPROVED BY PM	DATE	APPROVED BY MANAGER OF ENGR	DATE	SCALE
														JWR	2/10/2016	GK	3/3/2016	MLO	-	PEV	-	-	-	-
D	REVISED FOR AIR PERMIT RFD								PC		LDK		5/9/16											
C	REVISED FOR C15120503 BOILER SYSTEM RELIABILITY IMPROVEMENTS								JSH		MLO		04/12/16											
B	REVISED FOR C15120503 BOILER SYSTEM RELIABILITY IMPROVEMENTS								JSH		MLO		03/17/16											
A	FOR REVIEW & COMMENT								JWR		PC													

THE DESIGN AND PRINT ARE THE INTELLECTUAL PROPERTY OF VENTURE ENGINEERING & CONSTRUCTION, INC. IT MUST BE RETURNED WITH THE QUOTATION OR UPON DELIVERY OF MATERIAL AND EQUIPMENT AND MUST NOT BE USED IN MANUFACTURING FOR OTHERS EXCEPT BY PERMISSION OF OWNERS.

Fairmont Brine Processing PFD Mass Balance	
Project No.:	C15-1205-03
Project Name:	Fairmont Brine Processing
Rev.:	D
Rev. Date:	5/9/2016

Water and Steam New Boiler

Basis: 22,655 Steam Flow to Thermo-Compressor

Stream No.	41	60	151	152	153	154	155	161	162	163	164	167	168	169	170	171	180
Stream Name	STEAM CONDENSATE RETURN	STEAM TO THE EJECTOR	BOILER FEED WATER	BOILER FEED WATER	BOILER FEED WATER	285 PSIA STEAM	285 PSIA STEAM	BOILER BLOW DOWN	BOILER BLOW DOWN	285 PSIA STEAM	20 PSIA STEAM	CITY WATER	CITY WATER	CITY WATER	SOFTENED CITY WATER	POTABLE CITY WATER	285 PSIA STEAM
Temp F	176.79	414.2	235.0	235.0	315.0	414.2	414.2	414.2	110.0	414.2	228.0	60.0	60.0	60.0	60.0	60.0	414.2
Pres psia	47.5	289.7	19.7	314.7	295.0	289.7	289.7	289.7	1.3	289.7	19.7	0.3	0.3	0.3	0.3	0.3	289.7
Enth MMBtu/hr	-211.0	-1.08	5.2	5.1	7.1	28.4	27.6	0.5	0.7	0.8	0.8	0.6	0.2	0.0	0.0	0.1	-128.2
Total lb/hr	31,385.0	190.0	25,374.0	24,873.0	24,873.0	23,623.0	22,923.0	1,250.0	8,756.0	700.0	700.0	20,016.0	7,506.0	0.0	0.0	5,004.0	22,655.0
Total std L gpm	62.76		50.7	49.7	49.7			2.5	17.5			40.0	15.0	0.0	0.0	10.0	

Stream No.	189	192	193														
Stream Name	BOILER FEED WATER	Boiler stm to condensate pump traps	Condensate Tank to Hot well														
Temp F	235.0	414.2															
Pres psia	315.0	289.7															
Enth MMBtu/hr	0.2																
Total lb/hr	501.0	78.0	6,711.0														
Total std L gpm	1.0		13.4														

RELEASED FOR REVIEW AND COMMENT



Venture Engineering & Construction
 CONTRACT C12-1110-00 Pittsburgh, PA

FAIRMONT BRINE PROCESSING
 FAIRMONT, WV
 BRINE PROCESSING PLANT
 WATER & STEAM
 MASS BALANCE

DRAWING NUMBER **PFD-1004MB** REV. **D**



NO.	REVISION	DWN	CHK	ENG	PM	DATE	NO.	REVISION	DWN	CHK	ENG	PM	DATE	DESIGNED/DWN BY	DATE	CHECKED BY	DATE	CHECKED BY ENGR	DATE	APPROVED BY PM	DATE	APPROVED BY MANAGER OF ENGR	DATE	SCALE
														JWR	2/10/2016	GK	3/3/2016	MLO	-	PEV	-	-	-	NONE
D	REVISED FOR AIR PERMIT RFD								PC		LDK		5-9-16											
C	REVISED FOR C15120503 BOILER SYSTEM RELIABILITY IMPROVEMENTS								JSH		MLO		04/11/16											
B	REVISED FOR C15120503 BOILER SYSTEM RELIABILITY IMPROVEMENTS								JSH		MLO		03/16/16											
A	FOR REVIEW & COMMENT								JWR		PC													

THE DESIGN AND PRINT ARE THE INTELLECTUAL PROPERTY OF VENTURE ENGINEERING & CONSTRUCTION, INC. IT MUST BE RETURNED WITH THE QUOTATION OR UPON DELIVERY OF MATERIAL AND EQUIPMENT AND MUST NOT BE USED IN MANUFACTURING FOR OTHERS EXCEPT BY PERMISSION OF OWNERS.



ATTACHMENT C

DETAILED PROCESS DESCRIPTION



Fairmont Brine Processing, LLC

168 AFR Drive

Fairmont, WV

Type of Business

The Fairmont Brine Processing, LLC, West Virginia Water Treatment Facility produces distilled water for use in natural gas well development. The source water used is from natural gas well development and production. The source water is pretreated at the facility to remove oil and suspended solids. Following pretreatment, the water is processed to remove dissolved solids to a concentration of less than five hundred (500) mg/L.

The treated water is sold to primarily natural gas well drilling companies. The sodium and calcium chloride salts removed from the water are sold as products.

Facility History

This facility was originally permitted by AOP-Clearwater, LLC. The original application was submitted to WVDEP in December 2008 by MSES Consultants, Inc. on behalf of AOP-Clearwater, LLC. Permit R13-2794 was issued to AOP-Clearwater, LLC on May 12, 2009. The property was transferred from AOP to Fairmont Brine Processing (FBP) on March 28, 2012 and Permit R13-2794 was transferred to FBP on April 25, 2012. The plant was idle at the time of transfer. Prior to operating under FBP, a Request for Determination (RFD) was submitted on February 5, 2014 by Venture Engineering & Construction, Inc. on behalf of FBP. Based on this submittal, WVDEP determined that a permit was not required under 45CSR13. FBP has been operating under Permit R13-2794. At this time, the following proposed process/facility changes necessitate an additional RFD:

- Modify Source E-3: FBP plans to replace the existing third effect heat exchanger, 02-HX-003, which will allow for an increase in plant capacity. This change will increase Emissions E-3.
- Add Source S-6: FBP plans to expand their pretreatment operations to include chemical precipitation, clarification, and effluent and sludge processing. This includes the installation of a lime silo, 01-TK-015 (new Emissions E-6).
- Add Source S-7: FBP plans to install a second natural gas fueled boiler, 03-B-002 (new Emissions E-7) to provide a redundant heat source for the evaporation process.

NOTE: AOP-Clearwater, LLC included an emergency generator (Emissions E-5) on the original permit application. An emergency generator was not installed and FBP has no plans at this time to install an emergency generator.



Process Description

The FBP plant consists of three main processing operations: Brine Treatment, Evaporation and Crystallization. The three processes are described below.

Brine Treatment

The facility receives untreated brine water with limited (less than 0.1%) crude oil, suspended solids, and dissolved solids by tank trucks. After arrival and before unloading (unless previously characterized), the contents of the trucks are sampled and tested for chemical composition and physical properties. The trucks are unloaded on a concrete pad with the untreated brine water transferred to a concrete lined basin. The quantity of water is stored in a computer database for further correspondence. Oil is removed by an oil skimmer from the top of the basin and stored in an oil storage tank (Emissions E-4).

The treated brine water flows from the basin to the oil/water separator for oil removal to the oil storage tank. From the oil/water separator the treated brine water is currently pumped through bag filters for solids removal and then through activated carbon filters to remove the organics. Prior to filtration, FBP proposes to chemically treat the brine water using sodium sulfate (which is currently added to the basin) and two new treatment chemicals: hydrated lime and polymer (for increased flocculation). Hydrated lime will be stored in a lime silo (Emissions E-6). With the pretreatment process upgrades, the treated brine water will be pumped from the oil/water separator through a series of new chemical addition tanks where chemical dosing will occur to enable heavy metal precipitation.

Following chemical treatment, FBP plans to clarify the brine water using two inclined-plate clarifiers operating in parallel. The clarification system will include sludge handling equipment. With these changes, the treated brine water will flow from the chemical addition tanks through the clarifiers and into a new effluent storage tank. The treated brine water will be pumped from the effluent storage tank through the existing bag and activated carbon filters. Finally, the brine water from the pretreatment process will flow into the existing 5.25 million gallon HDPE lined brine pond impoundment allowing additional mixing and capacity prior to the evaporation process.

The sludge from the clarifiers will be pumped into a new thickener vessel and then filter pressed. The overflow from the thickener and filtrate from the new filter press will be returned to the clarifiers for reprocessing.

The solid waste generated will be disposed of via landfill. The oil is stored in the oil storage tank for external sale.



Evaporation

The brine water from the brine pond impoundment is currently processed at a rate of approximately 5,000 barrels per day to remove dissolved solids. With the replacement of the third effect heat exchanger, the process rate will increase to approximately 5,400 barrels per day. The heat source for the process is steam produced by a 30 million Btu per hour natural gas fueled boiler (Emissions E-1). FBP plans to install an additional 27 million Btu per hour natural gas fueled boiler (Emissions E-7) for redundant heat sources. The boilers cannot operate concurrently.

The brine water from the brine pond impoundment is pumped through bag filters and heat exchangers to preheat the brine water for processing. The brine water feed is then pumped to vapor liquid separators (VLSs) for evaporation. In the VLSs the brine water is concentrated as the distilled water is evaporated out the top of the vessel, passing through a mist eliminator vessel. A recirculating stream is pumped through the first effect heat exchanger and heated to allow vaporization of clean water from the brine water in the VLS. The water vapors from the first effect VLS continue to the second effect heat exchanger, which heats the recirculating brine in the second effect VLS system. The second effect VLS operates in the same manner as the first effect VLS where the water vapor from the top of the second VLS flows to the third effect heat exchanger for the recirculating of brine water to the third effect VLS. The brine water is delivered to the first and second VLSs in a parallel feed flow. Hence, the FBP plant has three vapor liquid separators with two operating in parallel for the process stream and three operating in series for efficient steam energy utilization.

The distilled water vapors from this process are condensed in the downstream heat exchangers and in a barometric condenser system. The distilled water is delivered to a hot well for delivery and storage in the existing 1.25 million gallon clean water pond.

The non-condensable vapors from the barometric condenser system and from mist eliminator lines are pumped through a vacuum pump separator and an activated carbon bed to atmosphere (Emissions E-3).



Crystallization

Salt crystallization begins in the VLSs as the water is evaporated and the concentration of the remaining brine exceeds the saturation point of the brine water solution. A salt crystal bearing brine water slurry is transferred between evaporators and then removed as a single stream leaving the third effect VLS. The slurry is pumped to the settler tank where continued salt formation occurs before it is transferred to the centrifuge. The salt crystals are separated from the concentrated brine water in the centrifuge and are then fed via a conveyor to a natural gas fueled rotary dryer (Emissions E-2). The wet salt cake from the conveyor is dried in the rotary dryer and then conveyed to a storage pile to await customer distribution. The concentrated brine water from the centrifuge is returned to the second and third effect VLSs for continued processing, as well as pumped to CaCl_2 storage for external sale.



ATTACHMENT D

MATERIAL SAFETY DATA SHEETS



The following MSDSs are provided as ATTACHMENT D:

Brine Treatment

- Untreated Brine
- Sodium Sulfate
- Hydrated Lime (NEW)
- Anionic Emulsion Polymer (NEW; MSDS provided for example only. Polymer selection is pending.)
- Pretreated Brine

Evaporation

- Defoamer
- Sodium Hydroxide (Use may be discontinued once process changes to use hydrated lime are implemented.)
- ISOPLUS – Boiler treatment
- CONDEN-SAF 4675 – Condensate Treatment
- Dubois OH 50 – Alkaline Builder
- ZT-65 – Water Softener Cleaning

Crystallization

- Heavy Brine
- Process Salt

MATERIAL SAFETY DATA SHEET

UNTREATED BRINE

FILE NO.:
MSDS DATE: 10/28/2015

SECTION 1: PRODUCT AND COMPANY IDENTIFICATION

PRODUCT NAME: UNTREATED BRINE
SYNONYMS: RAW WASTEWATER, BRINE SOLUTION, PRODUCED WATER, FORMATION WATER, FRACTIONATION WATER
PRODUCT CODES: N/A

MANUFACTURER: FAIRMONT BRINE PROCESSING, LLC
DIVISION: N/A
ADDRESS: 168 AFR DRIVE | FAIRMONT, WV 26554

EMERGENCY PHONE: (412) 680-6244
CHEMTREC PHONE: (800) 424-9300 (24 HOURS)
OTHER CALLS: (304) 363-9876
FAX PHONE: (412) 231-5891

CHEMICAL NAME: BRINE SOLUTION
CHEMICAL FAMILY: MIXTURE
CHEMICAL FORMULA: MIXTURE

PRODUCT USE: EVAPORATION/ CRYSTALLIZATION
PREPARED BY: LDK

SECTION 1 NOTES: Raw wastewater from incoming trucks (various producers)

SECTION 2: COMPOSITION/INFORMATION ON INGREDIENTS

<u>INGREDIENT</u>	<u>CAS NO.</u>	<u>% WT</u>
Water	7732-18-5	80-95
Calcium chloride	10043-52-4	0-10
Potassium chloride	7447-40-7	0-10
Sodium chloride	7647-14-5	0-10
Residual metals	Various	<5
Benzene	71-43-2	<1

SECTION 3: HAZARDS IDENTIFICATION

EMERGENCY OVERVIEW: WARNING! Causes eye irritation. The product may contain benzene which may cause cancer and cause blood disorders.

ROUTES OF ENTRY: Eye contact. Skin contact. Ingestion. Inhalation.

POTENTIAL HEALTH EFFECTS

EYES: Causes eye irritation

SKIN: Prolonged or repeated skin contact may cause irritation.

INGESTION: May cause gastrointestinal irritation, nausea, vomiting and diarrhea

INHALATION: No inhalation hazard under normal conditions. If misting occurs: may cause mild mucous membrane irritation of the nose, throat, and upper respiratory tract.

ACUTE HEALTH HAZARDS: Causes eye irritation.

CHRONIC HEALTH HAZARDS: May contain benzene. Human epidemiology studies indicate that prolonged and/or repeated overexposure to benzene may cause damage to the blood-producing system and serious blood disorders, including leukemia. Animal tests suggest that prolonged and/or repeated overexposure to benzene may damage the embryo/fetus. The relevance of these animal studies to humans has not been fully established.

CARCINOGENICITY

This product is not considered to be a carcinogen by IARC, ACGIH, NTP, or OSHA.

OSHA:	Benzene (CAS 71-43-2)	Cancer hazard
ACGIH:	Benzene (CAS 71-43-2)	A1 Confirmed human carcinogen
NTP:	Benzene (CAS 71-43-2)	Known carcinogen
IARC:	Benzene (CAS 71-43-2)	1 Carcinogenic to humans

MATERIAL SAFETY DATA SHEET

UNTREATED BRINE

FILE NO.:
MSDS DATE: 10/28/2015

SECTION 4: FIRST AID MEASURES

EYES: In case of contact, immediately flush eyes with fresh water for at least 15 minutes while holding the eyelids open. Remove contact lenses if worn. Get medical attention if irritation persists.

SKIN: Remove contaminated clothing and shoes. Wash affected area with mild soap and water. Get medical attention if irritation develops and persists.

INGESTION: Rinse mouth thoroughly. Get medical attention if any discomfort occurs

INHALATION: If breathing is difficult, remove to fresh air and keep at rest in a position comfortable for breathing. Call a physician if symptoms develop or persist.

SECTION 4 NOTES: If you feel unwell, seek medical advice (show the label where possible). Ensure that medical personnel are aware of the material(s) involved, and take precautions to protect themselves.

SECTION 5: FIRE-FIGHTING MEASURES

FLAMMABLE PROPERTIES: This product is not flammable; however sufficient hydrocarbon vapors may accumulate from oil or natural gas condensate floating on the surface of the produced water to cause a flash fire. The fire should burn out fairly rapidly depending on the amount of oil and natural gas condensate floating on the surface of the produced water.

EXTINGUISHING MEDIA

SUITABLE EXTINGUISHING MEDIA: Dry chemical powder. Foam. Carbon dioxide (CO₂).

PROTECTION OF FIREFIGHTERS

PROTECTIVE EQUIPMENT AND PRECAUTIONS FOR FIREFIGHTERS: A fire would be associated with vapors related to oil or natural gas condensate floating on the surface of the produced water. Water maybe ineffective on flames and may even spread the fire but should be used to cool pressurized containers in the fire.

SPECIAL PROTECTIVE EQUIPMENT FOR FIREFIGHTERS:

Firefighters should wear appropriate protective equipment and self-contained breathing apparatus (SCBA) with full face-piece operated in positive pressure mode. Use approved gas detectors in confined spaces.

SPECIFIC METHODS: Promptly isolate the scene by removing persons from the vicinity of the incident if there is a fire. Do not extinguish flames at leak because of the possibility of a uncontrolled re-ignition exists. If it is safe to do so, cut off fuel supply and/or allow fire to burn out. The fire should burn out fairly rapidly depending on the amount of oil and natural gas condensate floating on the surface of the produced water. If leak or spill has not ignited, water spray or ventilation can be used to disperse the vapors.

HAZARDOUS COMBUSTION PRODUCTS: Sodium oxides. Carbon oxides.

SECTION 6: ACCIDENTAL RELEASE MEASURES

ACCIDENTAL RELEASE MEASURES: Recover by pumping (use an explosion-proof motor or hand pump) or by sand or other oil absorbing materials. Carefully shovel, scoop or sweep up into a waste container for reclamation or disposal. Where feasible and appropriate, remove contaminated soil or flush with fresh water. On water spills utilize absorbent material to remove oil and natural gas liquid from the surface of the water.

SECTION 6 NOTES: Avoid excess skin contact with spilled material.

SECTION 7: HANDLING AND STORAGE

HANDLING: Avoid contact with skin, eyes and clothing. Wash thoroughly after handling.

STORAGE: Keep containers in well-ventilated area away from flame, sparks, excessive temperatures and open flames. Keep the containers closed and clearly labeled. Empty product containers or vessels may contain vapors. Do not pressurize, cut, heat, weld or expose such containers to sources of ignition. Do not enter storage areas and confined spaces without adequate ventilation. Use appropriate respiratory protection if there is the potential to exceed the exposure limit(s). Vapors containing benzene may accumulate during storage and transport.

SECTION 8: EXPOSURE CONTROLS/PERSONAL PROTECTION

VENTILATION: Ensure adequate ventilation, especially in confined areas.

RESPIRATORY PROTECTION: No personal respiratory equipment normally required.

EYE PROTECTION: If eye contact is likely, safety glasses should be worn.

MATERIAL SAFETY DATA SHEET
UNTREATED BRINE

FILE NO.:
MSDS DATE: 10/28/2015

SECTION 8: EXPOSURE CONTROLS/PERSONAL PROTECTION (Continued)

SKIN PROTECTION: No special garments required. Wash contaminated clothing prior to reuse.

OTHER PROTECTIVE CLOTHING OR EQUIPMENT: No other protective clothing or equipment is needed.

WORK HYGIENIC PRACTICES: Always observe good personal hygiene measures, such as washing after handling the material and before eating, drinking, and/or smoking. Routinely wash work clothing and protective equipment to remove contaminants. Discard contaminated clothing and footwear that cannot be cleaned. Handle in accordance with good industrial hygiene and safety practice.

SECTION 9: PHYSICAL AND CHEMICAL PROPERTIES

APPEARANCE: Dirty colored liquid

ODOR: Faint hydrocarbon odor

PHYSICAL STATE: Liquid

pH AS SUPPLIED: 4.5-7.5
pH (Other):

BOILING POINT:

F: 212°

C: 100°

MELTING POINT:

F: N/A

C: N/A

FREEZING POINT:

F: < 32°

C: < 0°

VAPOR PRESSURE (mmHg): 13.6 (approx.)

@ F: 68°

C: 20°

VAPOR DENSITY (AIR = 1): <1

@ F: 68°

C: 20°

SPECIFIC GRAVITY (H₂O = 1): 1.2 (approx.)

@ F: 68°

C: 20°

EVAPORATION RATE: N/A

SOLUBILITY IN WATER: Complete

PERCENT SOLIDS BY WEIGHT: N/A

PERCENT VOLATILE: N/A

BY WT/ BY VOL @

F:

C:

VOLATILE ORGANIC COMPOUNDS (VOC): N/A

WITH WATER: LBS/GAL

WITHOUT WATER: LBS/GAL

MOLECULAR WEIGHT: N/A

SECTION 10: STABILITY AND REACTIVITY

STABILITY: Stable

CONDITIONS TO AVOID (STABILITY): Keep away from heat, sparks, and open flame.

HAZARDOUS DECOMPOSITION OR BY-PRODUCTS: Carbon dioxide. Water vapor. May produce oxides of sulfur. Carbon monoxide via incomplete combustion.

HAZARDOUS POLYMERIZATION: Does not occur.

MATERIAL SAFETY DATA SHEET

UNTREATED BRINE

CONDITIONS TO AVOID (POLYMERIZATION): N/A

FILE NO.:

MSDS DATE: 10/28/2015

SECTION 11: TOXICOLOGICAL INFORMATION

TOXICOLOGICAL INFORMATION: This product may contain detectable but varying quantities of the naturally occurring radioactive substance Radium 226/228. Due to the long half life of Radium 226/228 (1600yr/5.75yr), there should not be significant radiation. The solution may cause eye and skin irritation.

SECTION 12: ECOLOGICAL INFORMATION

ECOLOGICAL INFORMATION: An environmental hazard cannot be excluded in the event of unprofessional handling or disposal.

SECTION 12 NOTES: To be expected to be harmful to aquatic organisms.

SECTION 13: DISPOSAL CONSIDERATIONS

WASTE DISPOSAL METHOD: Reuse or recycle if possible. All disposal practices must be in compliance with all Federal, State/Provincial and local laws and regulations. Regulations may vary in different locations. Waste characterizations and compliance with applicable laws are the responsibility solely of the waste generator. AS YOUR SUPPLIER, WE HAVE NO CONTROL OVER THE MANAGEMENT PRACTICES OR MANUFACTURING PROCESSES OF PARTIES HANDLING OR USING THIS MATERIAL. THE INFORMATION PRESENTED HERE PERTAINS ONLY TO THE PRODUCT AS SHIPPED IN ITS INTENDED CONDITION AS DESCRIBED IN MSDS SECTION: Composition Information. FOR UNUSED & UNCONTAMINATED PRODUCT, the preferred options include sending to a licensed, permitted: Reclaimer. Waste water treatment system.

SECTION 14: TRANSPORT INFORMATION

U.S. DOT 49 CFR 172.101:

Status: Not regulated

CANADIAN TRANSPORTATION OF DANGEROUS GOODS:

Status: Not regulated

OTHER AGENCIES:

SECTION 15: REGULATORY INFORMATION

U.S. REGULATIONS

OSHA REGULATORY STATUS: This material is considered hazardous by the OSHA Hazard Communication Standard (29 CFR 1910.1200)

CERCLA SECTIONS 102a/103 HAZARDOUS SUBSTANCES (40 CFR 302.4): Not regulated.

EPCRA EXTREMELY HAZARDOUS SUBSTANCES (40 CFR 355.30): Not regulated.

EPCRA SECTIONS 311/312 HAZARD CATEGORIES (40 CFR 370.10): Acute Health Hazard

EPCRA SECTION 313 (40 CFR 372.65): To the best of our knowledge, this product does not contain chemicals at levels which require reporting under this statute.

OSHA PROCESS SAFETY (PSM) (29 CFR 1910.119): Not regulated.

STATE REGULATIONS:

INTERNATIONAL REGULATIONS:

SECTION 16: OTHER INFORMATION

IMPORTANT:

The information presented herein, while not guaranteed, was prepared by technical personnel and is true and accurate to the best of our knowledge. **NO WARRANTY OF MERCHANTABILITY OR OF FITNESS FOR A PARTICULAR PURPOSE, OR WARRANTY OR GUARANTY OF ANY OTHER KIND, EXPRESS OR IMPLIED, IS MADE REGARDING PERFORMANCE, SAFETY, SUITABILITY, STABILITY OR OTHERWISE.** This information is not intended to be all-inclusive as to the manner and conditions of use, handling, storage, disposal and other factors that may involve other or additional legal, environmental, safety or performance considerations, and OxyChem assumes no liability whatsoever for the use of or reliance upon this information. While our technical personnel will be happy to respond to questions, safe handling and use of the product remains the responsibility of the customer. No suggestions for use are intended as, and nothing herein shall be construed as, a recommendation to infringe any existing patents or to violate any Federal, State, local or foreign laws. OSHA Standard 29 CFR 1910.1200 requires that information be provided to employees regarding the hazards of chemicals by means of a hazard communication program including labeling, safety data sheets, training and access to written records. We request that you, and it is your legal duty to, make all information in this Safety Data Sheet available to your employees.

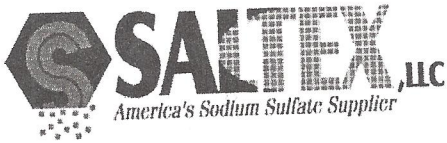

Saltex, LLC
7755 Bellaire South
Ft. Worth, TX 76132
USA Tel:
877-872-5839

MATERIAL SAFETY DATA SHEET
SODIUM SULFATE ANHYDROUS
January 1, 2013

SECTION I: CHEMICAL PRODUCT AND COMPANY INFORMATION

Product Name: Sodium Sulfate
General Use:
Common Synonyms: Sodium sulfate, Anhydrous; Sulfuric Acid, Disodium Salt;
Disodium Sulfate
Chemical Family: Neutral Salts
Formula: Na₂SO₄
Formula Weight: 142.04
CAS No.: 7757-82-6
Manufacturer: Saltex, LLC

SECTION II: COMPOSITION/INFORMATION ON INGREDIENTS

<u>Component</u>	<u>WEIGHT %</u>	<u>CAS #</u>
Sodium Sulfate, Anhydrous	99 - 100	7757-82-6

<u>Component</u>	<u>Hazard</u>	<u>OSHA STEL</u>	<u>OSHA PEL</u>	<u>ACGIH TLV</u>
Sodium Sulfate, Anhydrous	Irritant	N/E	N/E	N/E

EXTENDED INFORMATION

SECTION III: HAZARDS IDENTIFICATION

EMERGENCY OVERVIEW

CAUTION! MAY CAUSE IRRITATION. MAY BE HARMFUL IF SWALLOWED OR INHALED. HYGROSCOPIC. During use avoid contact with eyes, skin or clothing. Wash thoroughly after handling. When not in use, keep in tightly closed container.

POTENTIAL HEALTH EFFECTS

EYE CONTACT: Irritation
SKIN CONTACT: Irritation
INGESTION: Gastrointestinal irritation
INHALATION: Irritation of the upper respiratory tract.
CHRONIC: None identified
TARGET ORGANS: Respiratory system, lungs.

Sodium Sulfate

Primary routes of entry:

Inhalation

Ingestion

Skin Contact

Eye Contact

MEDICAL CONDITIONS AGGRAVATED BY EXPOSURE: None identified

SECTION III: FIRST AID MEASURES

EYE CONTACT:

In case of eye contact, immediately flush with plenty of water for at least 15 minutes.

SKIN CONTACT:

In case of contact, immediately wash skin with plenty of soap and water for at least 15 minutes.

INGESTION:

If swallowed and the person is conscious, immediately give large amounts of water. Get medical attention.

INHALATION:

If a person breathers in large amounts, move the exposed person to fresh air.

NOTES TO PHYSICIAN: None

SECTION V: FIRE FIGHTING INFORMATION

Flashpoint (Degrees C) and Method: N/A
Auto ignition Temperature (Degrees C): N/A

FLAMMABLE LIMITS:

Components

Upper Explosive Limit

Lower Explosive Limit

Sodium Sulfate, Anhydrous

N/A

N/A

GENERAL HAZARD:

Unusual Fire and Explosion Hazards:

None Identified.

FIRE FIGHTING INSTRUCTIONS:

Use extinguishing media appropriate for surrounding fire.

FIRE FIGHTING EQUIPMENT:

Firefighters should wear proper protective equipment and self-contained breathing Apparatus with full facepiece operated in positive pressure mode.

EXTINGUISHING MEDIA:

Foam

Alcohol Foam

CO2

Dry Chemical

Water

Other

Sodium Sulfate

HAZARDOUS COMBUSTION PRODUCTS:
Combustion may release sulfur dioxide.

NATIONAL FIRE PROTECTION ASSOCIATION (NFPA):
NFPA Hazard Rating: 0 – Insignificant 1 – Slight 2 – Moderate
 3 - High 4 – Extreme 5 – Unknown
 *- No Information

Health :0
Flammability :0
Reactivity :0

SPECIAL INFORMATION:

Contact Hazard:	Slight (1)
Explosion Data – Sensitivity to Mechanical Impact:	None Identified
Explosion Data - Sensitivity to Static Discharge:	None Identified

SECTION VI: ACCIDENTAL RELEASE MEASURES

LAND SPILL:
Wear suitable protective clothing. Sweep up and remove.

SECTION VII: HANDLING AND STORAGE

GENERAL STORAGE CONDITIONS:
Keep container tightly closed. Keep from contact with oxidizing materials. Isolate from incompatible materials.
Special Precautions: material is hygroscopic.

SECTION VIII: EXPOSURE CONTROLS/PERSONAL PROTECTION

ENGINEERING CONTROLS:
Use adequate general or local exhaust ventilation to keep fume or dust levels as low as possible.

PERSONAL PROTECTION:

RESPIRATOR:
None required where adequate ventilation conditions exist. If airborne concentration is high, use an appropriate respirator or dust mask.

PROTECTIVE CLOTHING:
Safety goggles, rubber gloves recommended.

SECTION VIII: PHYSICAL AND CHEMICAL PROPERTIES

Vapor Pressure (mmHg): N/A Solubility in Water: Appreciable
Specific Gravity (water=1): 2.68 pH: 6-10

Sodium Sulfate

Boiling Point (Degrees C): N/A Physical State: Sol.id
Freezing Point (Degrees C): 884 Vapor Density (air=1): N/A
Evaporation Rate (BuAc=1): N/A Percent Volatile by Volume:0
Viscosity: Odor: Odorless
Appearance: White crystals or powder

SECTION X: STABILITY AND REACTIVITY

GENERAL:

STABILITY:

Stable:

Unstable:

HAZARDOUS POLYMERIZATION:

Will Not Occur:

Will Occur:

INCOMPATIBLE MATERIALS:

Strong oxidizing agents.

CONDITIONS TO AVOID:

Moisture

HAZARDOUS DECOMPOSITION PRODUCTS:

Oxides of sulfur.

SECTION XI: TOXICOLOGICAL INFORMATION

GENERAL:

Sodium Sulfate, Anhydrous:

5989 mg/kg oral mouse LD50

Carcinogenicity: None identified

Reproductive Effects: None identified

CARCINOGENIC INFORMATION:

Component	CAS#	Weight%	IARC	NTP	OSHA	ACGIH	Other
Sodium Sulfate Anhydrous	7757-82-6	99-100	No	No	No	No	No

SECTION XII: ECOLOGICAL INFORMATION

Environmental Fate:

When released into the soil, this material is expected to leach into groundwater. This material is not expected to significantly bioaccumulate.

Environmental Toxicity:

This material is not expected to be toxic to aquatic life. The LC50/96-hour values for fish are over 100 mg/l. The EC50/48-hour values for daphnia are over 100 mg/l.

SECTION XIII: DISPOSAL CONSIDERATION

RCRA Hazard Class: None

METHOD OF DISPOSAL:

Sodium Sulfate

Dispose of in accordance with all applicable federal, state and local environmental regulations.

SECTION XIII: TRANSPORTATION INFORMATION

DOT (Department of Transportation)

Proper Shipping Name: Chemicals, n.o.s. (non-regulated)
Hazard Class: None
Identification Number: None / No UN Number assigned

SECTION XV: REGULATORY INFORMATION

TSCA (Toxic Substances Control Act):

In TSCA Inventory? Yes No

CERCLA (Comprehensive Environmental Response Compensation, and Liability Act):
Classified as a Hazardous Substance? Yes No

SARA TITLE III (Superfund Amendments and Reauthorization Act):

311/312 Hazard Categories:

Acute Chronic Flammability Pressure Reactivity None

313 Reportable Ingredients: None

CALIFORNIA PROPOSITION 65: Not Listed

SECTION XVI: OTHER INFORMATION

Saltex, LLC provides the information contained herein in good faith but makes no representation as to its comprehensiveness or accuracy. This document is intended only as a guide to the appropriate precautionary handling of the material by a properly trained person using this product. Individuals receiving the information must exercise their independent judgment in determining its appropriateness for a particular purpose.

SALTEX, LLC MAKES NO REPRESENTATIONS, OR WARRANTIES, EITHER EXPRESS OR IMPLIED, INCLUDING WITHOUT LIMITATION ANY WARRANTIES OF MERCHANTABILITY, OR FITNESS FOR A PARTICULAR PURPOSE WITH RESPECT TO THE INFORMATION SET FORTH HEREIN OR THE PRODUCT TO WHICH THE INFORMATION REFERS. ACCORDINGLY, SALTEX, LLC WILL NOT BE RESPONSIBLE FOR DAMAGES RESULTING FROM USE OF OR RELIANCE UPON THIS INFORMATION.

N/A: Not Available, Not Applicable

N/D: Not Determined

N/E: Not Established

Sodium Sulfate

Safety Data Sheet

Issue Date: 27-Jan-2012

Revision Date: 20-July-2015

Version 1

1. IDENTIFICATION

Product Identifier

Product Name Hydrated Lime

Other means of identification

SDS # WKM-002

Recommended use of the chemical and restrictions on use

Recommended Use Water Treatment, Flue Gas Desulfurization, pH Adjustment, Construction

Details of the supplier of the safety data sheet

Manufacturer Address

Mid-Ohio Valley Lime
16360 State Route Seven South
Marietta, OH 45750

Emergency Telephone Number

Company Phone Number 1-888-847-3090
Emergency Telephone (24 hr) INFOTRAC 1-352-323-3500 (International)
1-800-535-5053 (North America)

2. HAZARDS IDENTIFICATION

Appearance White or grayish-white solid powder

Physical State solid

Odor Odorless

Classification

Skin corrosion/irritation	Category 2
Serious eye damage/eye irritation	Category 1
Carcinogenicity	Category 1A
Specific Target Organ Toxicity – Single Exposure	Category 3

Signal Word

Danger

Hazard Statements

Causes severe skin burns and eye damage
May cause respiratory irritation
May cause cancer through inhalation



Precautionary Statements - Prevention

Obtain special instructions before use
 Do not handle until all safety precautions have been read and understood
 Use personal protective equipment as required
 Do not breathe dust
 Wash face, hands and any exposed skin thoroughly after handling

Precautionary Statements - Response

Immediately call a poison center or doctor/physician
 IF IN EYES: Rinse cautiously with water for several minutes. Remove contact lenses, if present and easy to do. Continue rinsing
 IF ON SKIN (or hair): Remove/Take off immediately all contaminated clothing. Rinse skin with water/shower
 Wash contaminated clothing before reuse
 IF INHALED: Remove victim to fresh air and keep at rest in a position comfortable for breathing
 IF SWALLOWED: Rinse mouth. Do NOT induce vomiting

Precautionary Statements - Storage

Store locked up

Precautionary Statements - Disposal

Dispose of contents/container to an approved waste disposal plant

3. COMPOSITION/INFORMATION ON INGREDIENTS

Chemical Name	CAS No	Weight-%
Calcium Hydroxide	1305-62-0	>85
Quartz	14808-60-7	<1

If Chemical Name/CAS No is "proprietary" and/or Weight-% is listed as a range, the specific chemical identity and/or percentage of composition has been withheld as a trade secret.

4. FIRST-AID MEASURES

First Aid Measures

General Advice	Immediately call a poison center or doctor/physician. Provide this SDS to medical personnel for treatment.
Eye Contact	IF IN EYES: Rinse generously with water for several minutes. Remove contact lenses, if present and easy to do. Pull back the eyelid to ensure that all lime dust has been washed out. Seek medical attention immediately. Do not rub eyes.
Skin Contact	IF ON SKIN (or hair): Remove/Take off immediately all contaminated clothing. Rinse skin with water/shower. Wash contaminated clothing before reuse.
Inhalation	IF INHALED: Remove victim to fresh air and keep at rest in a position comfortable for breathing.
Ingestion	IF SWALLOWED: Rinse mouth. Do NOT induce vomiting.

Most important symptoms and effects

Symptoms	Causes severe skin burns and eye damage. May cause cancer. Contact may aggravate disorders of the eyes, skin, gastrointestinal tract, and respiratory system.
-----------------	---------------------------------------------------------------------------------------------------------------------------------------------------------------

Indication of any immediate medical attention and special treatment needed

Notes to Physician	Treat symptomatically.
---------------------------	------------------------

5. FIRE-FIGHTING MEASURES

Suitable Extinguishing Media

Use dry chemical fire extinguisher.

Unsuitable Extinguishing Media Do not use water or halogenated compounds. Only use large amounts of water that can be used to deluge small quantities of this product.

Specific Hazards Arising from the Chemical

Hydrated Lime is not combustible or flammable. However, it reacts vigorously with acids, and may release heat sufficient to ignite combustible materials in specific instances. Hydrated Lime is not considered to be an explosion hazard, although reaction with acids or other incompatible materials may rupture containers. When Hydrated Lime becomes wet, it can be slippery and can result in a slip hazard.

Hazardous Combustion Products Smoke, fumes or vapors, and oxides of carbon.

Protective equipment and precautions for firefighters

Keep personnel away from and upwind of fire. Avoid skin contact or inhalation of dust. Wear full fire-fighting turn-out gear (full Bunker gear), and respiratory protection (self-contained breathing apparatus).

6. ACCIDENTAL RELEASE MEASURES

Personal precautions, protective equipment and emergency procedures

Personal Precautions Use personal protective equipment as required.

Other Information Spill Procedures: Do not use water on bulk materials spills. Use proper protective equipment. Use personal protective equipment (eyes, skin, and inhalation). Use copious amounts of water to dilute. Follow proper drainage and disposal procedure.
 Small Spills: Do not clean up with compressed air. Store collected materials in sealed plastic or non-aluminum containers. Residue on surfaces may be water washed.
 Large Spills: Evacuate area downwind of clean-up operations to minimize dust exposure. Store spilled materials in sealed plastic or non-aluminum containers.

Environmental Precautions See Section 12 for additional Ecological Information.

Methods and material for containment and cleaning up

Methods for Containment Minimize dust generation and prevent bulk release to sewers or waterways.

Methods for Clean-Up Residual amounts of material can be flushed with large amounts of water. Avoid dry sweeping. Equipment can be washed with either a mild vinegar and water solution, or detergent and water. Dispose according to federal, provincial/ state and local environmental regulations.

7. HANDLING AND STORAGE

Precautions for safe handling

Advice on Safe Handling Handle in accordance with good industrial hygiene and safety practice. Obtain special instructions before use. Do not handle until all safety precautions have been read and understood. Use personal protective equipment as required. Avoid generating airborne dust. Do not breathe dust. Wash face, hands, and any exposed skin thoroughly after handling. Wash contaminated clothing before reuse.

Conditions for safe storage, including any incompatibilities

Storage Conditions	Store in cool, dry, and well-ventilated locations. Keep in tightly closed containers. Do not store near acids or other incompatible materials. Keep away from moisture. Do not store or ship in aluminum containers.
Packaging Materials	Do not store or ship in aluminum containers.
Incompatible Materials	Acids; reactive fluoridated, brominated or phosphorous compounds; aluminum (may form hydrogen gas), reactive powdered metals; organic acid anhydrides; nitro-organic compounds; interhalogenated compounds.

8. EXPOSURE CONTROLS/PERSONAL PROTECTION

Exposure Guidelines

Chemical Name	ACGIH TLV	OSHA PEL	NIOSH IDLH
Calcium Hydroxide 1305-62-0	TWA: 5 mg/m ³	TWA: 15 mg/m ³ total dust TWA: 5 mg/m ³ respirable fraction (vacated) TWA: 5 mg/m ³ not in effect as a result of reconsideration	TWA: 5 mg/m ³
Quartz 14808-60-7	TWA: 0.025 mg/m ³ respirable fraction	(vacated) TWA: 0.1 mg/m ³ respirable dust : (30)/(%SiO ₂ + 2) mg/m ³ TWA total dust : (250)/(%SiO ₂ + 5) mppcf TWA respirable fraction : (10)/(%SiO ₂ + 2) mg/m ³ TWA respirable fraction	IDLH: 50 mg/m ³ respirable dust TWA: 0.05 mg/m ³ respirable dust

Appropriate engineering controls

Engineering Controls	Apply technical measures to comply with the occupational exposure limits. Use with local exhaust ventilation. Eye wash and safety showers should be immediately available.
-----------------------------	----------------------------------------------------------------------------------------------------------------------------------------------------------------------------

Individual protection measures, such as personal protective equipment

Eye/Face Protection	Eye protection (chemical goggles, safety glasses with side shields) should be worn where there is risk of airborne dust. Contact lenses should not be worn when working with this product.
Skin and Body Protection	Use appropriate gloves and footwear to prevent skin contact. Clothing should fully cover arms and legs. Should hydrated lime get inside clothing, gloves, or contact skin, remove the clothing and hydrated lime promptly.
Respiratory Protection	Use NIOSH/MSHA approved respirators if airborne concentration exceeds PEL.

General Hygiene Considerations Handle in accordance with good industrial hygiene and safety practice.

9. PHYSICAL AND CHEMICAL PROPERTIES

Information on basic physical and chemical properties

Physical State	solid	Odor	Odorless
Appearance	White or grayish-white liquid powder	Odor Threshold	Not established
Color	White or grayish-white		
Property	Values	Remarks • Method	
pH	12.4	@ 25 °C (77 °F)	
Melting Point/Freezing Point	580 °C / 1076 °F		
Boiling Point/Boiling Range	2850 °C / 5162 °F		
Flash Point	Not flammable		

Evaporation Rate	Similar to water
Flammability (Solid, Gas)	Not applicable- liquid
Upper Flammability Limits	Not flammable
Lower Flammability Limit	Not flammable
Vapor Pressure	Non volatile
Vapor Density	Non volatile
Specific Gravity	1.1-1.4
Water Solubility	Slightly soluble in water: .2% @ 0 °C. Soluble in acids, glycerin, and sugar solutions.
Solubility in other solvents	Soluble in acids, glycerol and sugar solutions
Partition Coefficient	Not determined
Auto-ignition Temperature	Not determined
Decomposition Temperature	Not determined
Kinematic Viscosity	Not determined
Dynamic Viscosity	Not determined
Explosive Properties	Not determined
Oxidizing Properties	Not determined
Molecular weight	74.093 g/mol

10. STABILITY AND REACTIVITY

Reactivity

Reacts with acids to form calcium salts while generating heat. Reacts with carbon dioxide in air to form calcium carbonate.

Chemical Stability

Stable under recommended storage conditions.

Possibility of Hazardous Reactions

None under normal processing.

Hazardous Polymerization Hazardous polymerization does not occur.

Conditions to Avoid

Incompatible Materials.

Incompatible Materials

Acids; reactive fluoridated, brominated or phosphorous compounds; aluminum (may form hydrogen gas), reactive powdered metals; organic acid anhydrides; nitro-organic compounds; interhalogenated compounds.

Hazardous Decomposition Products

Smoke, fumes or vapors, and oxides of carbon.

11. TOXICOLOGICAL INFORMATION

Information on likely routes of exposure

Product Information

Eye Contact	Causes serious eye damage.
Skin Contact	Causes severe skin burns.
Inhalation	Causes severe irritation of the respiratory system.
Ingestion	Causes severe irritation or burning of gastrointestinal tract if swallowed.

Component Information

Chemical Name	Oral LD50	Dermal LD50	Inhalation LC50
Calcium Hydroxide 1305-62-0	= 7340 mg/kg (Rat)	-	-
Quartz 14808-60-7	= 500 mg/kg (Rat)	-	-

Information on physical, chemical and toxicological effects

Symptoms Please see section 4 of this SDS for symptoms.

Delayed and immediate effects as well as chronic effects from short and long-term exposure

Carcinogenicity Hydrated Lime is not listed by MSHA, OSHA, or IARC as a carcinogen, but this product may contain trace amounts of crystalline silica, which has been classified by IARC as carcinogenic to humans when inhaled in the form of quartz crystobalite.

Chemical Name	ACGIH	IARC	NTP	OSHA
Quartz 14808-60-7	A2	Group 1	Known	X

Numerical measures of toxicity

The following toxicological characteristics apply:

LD50: 7,340 mg/kg (oral, rat)

LD50: 7,300 mg/kg (oral, mouse)

12. ECOLOGICAL INFORMATION

Ecotoxicity

The product is not classified as environmentally hazardous. However, this does not exclude the possibility that large or frequent spills can have a harmful or damaging effect on the environment.

Chemical Name	Algae/aquatic plants	Fish	Toxicity to microorganisms	Crustacea
Calcium Hydroxide 1305-62-0		160: 96 h Gambusia affinis mg/L LC50 static		

Persistence/Degradability

Not determined.

Bioaccumulation

Not determined.

Mobility

Not determined

Other Adverse Effects

Not determined

13. DISPOSAL CONSIDERATIONS

Waste Treatment Methods

Disposal of Wastes Disposal should be in accordance with applicable regional, national and local laws and regulations.

Contaminated Packaging Disposal should be in accordance with applicable regional, national and local laws and regulations.

California Hazardous Waste Status This product contains one or more substances that are listed with the State of California as a hazardous waste

Chemical Name	California Hazardous Waste Status
Calcium Hydroxide 1305-62-0	Corrosive

14. TRANSPORT INFORMATION

Note Please see current shipping paper for most up to date shipping information, including exemptions and special circumstances.

DOT Not regulated

IATA Not regulated

IMDG Not regulated

15. REGULATORY INFORMATION

International Inventories

Chemical Name	TSCA	DSL	NDSL	EINECS	ELINCS	ENCS	IECSC	KECL	PICCS	AICS
Calcium Hydroxide	Present	X		Present		Present	X	Present	X	X
Quartz	Present	X		Present		Present	X	Present	X	X

Legend:

TSCA - United States Toxic Substances Control Act Section 8(b) Inventory

DSL/NDSL - Canadian Domestic Substances List/Non-Domestic Substances List

EINECS/ELINCS - European Inventory of Existing Chemical Substances/European List of Notified Chemical Substances

ENCS - Japan Existing and New Chemical Substances

IECSC - China Inventory of Existing Chemical Substances

KECL - Korean Existing and Evaluated Chemical Substances

PICCS - Philippines Inventory of Chemicals and Chemical Substances

AICS - Australian Inventory of Chemical Substances

US Federal Regulations

SARA 313

Section 313 of Title III of the Superfund Amendments and Reauthorization Act of 1986 (SARA). This product does not contain any chemicals which are subject to the reporting requirements of the Act and Title 40 of the Code of Federal Regulations, Part 372

CWA (Clean Water Act)

This product does not contain any substances regulated as pollutants pursuant to the Clean Water Act (40 CFR 122.21 and 40 CFR 122.42)

US State Regulations

California Proposition 65

This product contains the following Proposition 65 chemicals.

Chemical Name	California Proposition 65
Quartz - 14808-60-7	Carcinogen

U.S. State Right-to-Know Regulations

Chemical Name	New Jersey	Massachusetts	Pennsylvania
Calcium Hydroxide 1305-62-0	X	X	X

Quartz 14808-60-7	X	X	X
----------------------	---	---	---

16. OTHER INFORMATION

<u>NFPA</u>	Health Hazards	Flammability	Instability	Special Hazards
	1	0	0	-
<u>HMIS</u>	Health Hazards	Flammability	Physical Hazards	Personal Protection
	2	0	0	E

Issue Date: 27-Jan-2012
 Revision Date: 13-Apr-2015
 Revision Note: New format

Disclaimer

The information provided in this Safety Data Sheet is correct to the best of our knowledge, information and belief at the date of its publication. The information given is designed only as a guidance for safe handling, use, processing, storage, transportation, disposal and release and is not to be considered a warranty or quality specification. The information relates only to the specific material designated and may not be valid for such material used in combination with any other materials or in any process, unless specified in the text.

End of Safety Data Sheet

SAFETY DATA SHEET

According to Federal Regulation 29 CFR 1910.1200

SECTION 1. Identification of the substance/mixture and of the company/undertaking

1.1. Product identifier

Product names: TRAMFLOC® 100 to 199 Series Anionic Emulsion polymers

Type of product: Mixture

1.2. Relevant identified uses of the substance or mixture and uses advised against

Identified uses: Processing aid for industrial applications.

Uses advised against: none

1.3. Details of the supplier of the safety data sheet

Company: Tramfloc, Inc.
6046 FM 2920 Rd. #615
Spring, TX 77379-2542
Telephone: 888-929-8973
Telefax: 480-383-6895
E-mail address: water@tramfloc.com

1.4 Emergency telephone number:

24-hour emergency number: 800-424-9300 CHEMTREC (CCN 20412), Outside US 703-527-3887

SECTION 2. Hazards identification

2.1. Classification of the substance or mixture

Classification according to paragraph (d) of Regulation 29 CFR 1910.1200:

Not classified.

2.2. Label elements

Labelling according to paragraph (f) of Regulation 29 CFR 1910.1200:

Hazard symbol(s): none
Signal word: none
Hazard statement(s): none
Precautionary statement(s): none

2.3. Other hazards

Aqueous solutions or powders that become wet render surfaces extremely slippery.

SECTION 3. Composition/information on ingredients

3.1 Substances

Not applicable, this product is not a substance.

3.2 Mixtures

Hazardous components

Distillates (petroleum), hydrotreated light

Concentration/ gamme : 20-45%

CAS Number: 64742-47-8

Classification according to paragraph

(d) of Regulation 29 CFR 1910.1200: Asp. Tox. 1: H304

Notes:

Does not result in classification of the mixture if the kinematic viscosity is greater than 20.5 mm²/s measured at 40°C.

Poly(oxy-1,2-ethanediyl), a-tridecyl-w-hydroxy-, branched

Concentration/ gamme : < 3%

CAS Number: 69011-36-5

Classification according to paragraph

(d) of Regulation 29 CFR 1910.1200: Acute Tox.4; H302, Eye Dam. 1; H318

For explanation of abbreviations see section 16

SECTION 4. First aid measures

4.1. Description of first aid measures

Inhalation:

Move to fresh air. No hazards which require special first aid measures.

Skin contact:

Wash off immediately with soap and plenty of water while removing all contaminated clothes and shoes. In case of persistent skin irritation, consult a physician.

Eye contact:

Rinse immediately with plenty of water, also under the eyelids, for at least 15 minutes. Alternatively, rinse immediately with Diphoterine®. Get prompt medical attention.

Ingestion:

Rinse mouth with water. Do NOT induce vomiting. Call a physician or poison control centre immediately.

4.2. Most important symptoms and effects, both acute and delayed

None under normal use.

4.3. Indication of any immediate medical attention and special treatment needed.

None reasonably foreseeable.

Other information:

None.

SECTION 5. Fire-fighting measures

5.1. Extinguishing media

Suitable extinguishing media:

Water. Water spray. Foam. Carbon dioxide (CO₂). Dry powder.

Unsuitable extinguishing media:

None.

5.2. Special hazards arising from the substance or mixture

Hazardous decomposition products:

Carbon oxides (CO_x). Nitrogen oxides (NO_x). Hydrogen cyanide (hydrocyanic acid) may be produced in the event of combustion in an oxygen deficient atmosphere.

5.3. Advice for fire-fighters

Protective measures:

Wear self-contained breathing apparatus and protective suit.

Other information:

Spills produce extremely slippery surfaces.

SECTION 6: Accidental release measures

6.1. Personal precautions, protective equipment and emergency procedures

Personal precautions:

Do not touch or walk through spilled material. Spills produce extremely slippery surfaces.

Protective equipment:

Wear suitable protective clothing, gloves and eye/face protection.

Emergency procedures:

Keep people away from spill/leak.

6.2. Environmental precautions

As with all chemical products, do not flush into surface water.

6.3. Methods and material for containment and cleaning up

Small spills:

Do not flush with water. Soak up with inert absorbent material. Sweep up and shovel into suitable containers for disposal.

Large spills:

Do not flush with water. Dam up. Clean up promptly by scoop or vacuum.

Residues:

Soak up with inert absorbent material. After cleaning, flush away traces with water.

6.4. Reference to other sections

SECTION 8: Exposure controls/personal protection; SECTION 13: Disposal considerations; SECTION 7: Handling and storage;

SECTION 7. Handling and storage

7.1. Precautions for safe handling

Avoid contact with skin and eyes. Renders surfaces extremely slippery when spilled. When using, do not eat, drink or smoke.

7.2. Conditions for safe storage, including any incompatibilities.

Keep away from heat and sources of ignition. Freezing will affect the physical condition and may damage the material. Incompatible with oxidizing agents.

7.3. Specific end use(s)

None.

SECTION 8. Exposure controls/personal protection

8.1. Control parameters

Occupational exposure limits:

Distillates (petroleum), hydrotreated light

ACGIH: 200 mg/m³ (8-hour)

8.2. Exposure controls

Appropriate engineering controls:

Use local exhaust if dusting occurs. Natural ventilation is adequate in absence of dusts.

Individual protection measures, such as personal protective equipment:

Eye/face protection: Safety glasses with side-shields.

Skin protection: Wear coveralls and/or chemical apron and rubber footwear where physical contact can occur.

Hand protection: PVC or other plastic material gloves.

Respiratory protection: No personal respiratory protective equipment normally required.

Additional advice: Wash hands before breaks and at the end of workday. Handle in accordance with good industrial hygiene and safety practice. Wash hands and face before breaks and immediately after handling the product.

Environmental exposure controls: Do not allow uncontrolled discharge of product into the environment.

SECTION 9. Physical and chemical properties

9.1. Information on basic physical and chemical properties

Appearance: Viscous liquid, Milky.

Odor: Aliphatic

Odor Threshold: Not applicable.

pH: 5 - 8 @ 5 g/L

Melting point/freezing point: > 5°C

Initial boiling point and boiling range: > 100°C

Flash point: Not applicable.

Evaporation rate:	Not applicable.
Flammability (solid, gas):	No data available.
Upper/lower flammability or explosive limits:	Not expected to create explosive atmospheres.
Vapour pressure:	2.3 kPa @ 20°C
Relative density:	1.0 – 1.2
Solubility(ies):	Completely miscible.
Partition coefficient:	Not applicable.
Autoignition temperature:	No data available.
Decomposition temperature:	> 150°C
Viscosity:	> 20.5 mm ² /s @ 40°C
Explosive properties:	Not expected to be explosive based on the chemical structure.
Oxidizing properties:	Not expected to be oxidizing based on the chemical structure.

9.2. Other information

None.

SECTION 10. Stability and reactivity

10.1. Reactivity

Stable under recommended storage conditions.

10.2. Chemical stability

Stable under recommended storage conditions.

10.3. Possibility of hazardous reactions

None known.

10.4. Conditions to avoid

Protect from frost, heat and sunlight.

10.5. Incompatible materials

Incompatible with oxidizing agents.

10.6. Hazardous decomposition products

Thermal decomposition may produce: nitrogen oxides (NO_x), carbon oxides (CO_x). Hydrogen cyanide (hydrocyanic acid) may be produced in the event of combustion in an oxygen deficient atmosphere.

SECTION 11. Toxicological information

11.1. Information on toxicological effects

Information on the product as supplied:

Acute oral toxicity:	LD50/oral/rat > 5000 mg/kg
Acute dermal toxicity:	LD50/dermal/rat > 5000 mg/kg
Acute inhalation toxicity:	The product is not expected to be toxic by inhalation.
Skin corrosion/irritation:	Not irritating.

Serious eye damage/eye irritation: Slightly irritating.

Respiratory/skin sensitization: Not sensitizing.

Mutagenicity: Not mutagenic.

Carcinogenicity: Not carcinogenic.

Reproductive toxicity: Not toxic for reproduction.

STOT - single exposure: No known effects.

STOT - repeated exposure: No known effects.

Aspiration hazard: Due to the viscosity, this product does not present an aspiration hazard.

Relevant information on the hazardous components:

Distillates (petroleum), hydrotreated light

Acute oral toxicity: LD50/oral/rat > 5000 mg/kg (OECD 401)

Acute dermal toxicity: LD50/dermal/rabbit > 5000 mg/kg (OECD 402)

Acute inhalation toxicity: LC50/inhalation/4 h/rat = 4951 mg/m³ (OECD 403)

Skin corrosion/irritation: Not irritating. (OECD 404)

Repeated exposure may cause skin dryness or cracking.

Serious eye damage/eye irritation: Not irritating. (OECD 405)

Respiratory/skin sensitisation: By analogy with similar products, this product is not expected to be sensitizing. (OECD 406)

Mutagenicity: Not mutagenic. (OECD 471, 473, 474, 476, 478, 479)

Carcinogenicity: Carcinogenicity study in rats (OECD 451): Negative

Reproductive toxicity: By analogy with similar substances, this substance is not expected to be toxic for reproduction. NOAEL/rat = 300 ppm (OECD 421)

STOT - single exposure: No known effects.

STOT - repeated exposure: NOAEL/oral/rat/90 days >= 3000 mg/kg/day (OECD 408) (Based on results obtained from tests on analogous products.).

Aspiration hazard: May be fatal if swallowed and enters airways.

Poly(oxy-1,2-ethanediyl), n-tridecyl-w-hydroxy-, branched

Acute oral toxicity: LD50/oral/rat = 200 - 300 mg/kg

Acute dermal toxicity: LD50/dermal/rabbit > 2000 mg/kg

Acute inhalation toxicity: No data available.

Skin corrosion/irritation: Not irritating.

Serious eye damage/eye irritation: Causes serious eye irritation.

Respiratory/skin sensitisation: The results of testing on guinea pigs showed this material to be non-sensitizing.

Mutagenicity: Not mutagenic.

Carcinogenicity: Not carcinogenic.

Reproductive toxicity: Two-Generation Reproduction Toxicity (OECD 416)
NOAEL/rat > 250 mg/kg/day
Prenatal Development Toxicity Study (OECD 414)
NOAEL/Maternal toxicity/rat > 50 mg/kg/day
NOAEL/Developmental toxicity/rat > 50 mg/kg/day

STOT - single exposure: No known effects.

STOT - repeated exposure: NOAEL/oral/rat/600 days = 50 mg/kg/day

Aspiration hazard: No known effects.

SECTION 12. Ecological information

12.1. Toxicity

Information on the product as supplied:

Acute toxicity to fish: LC50/Fish/96 hours > 100 mg/L

Acute toxicity to invertebrates: EC50/Daphnia/48 hours > 100 mg/L

Acute toxicity to algae: IC50/Algae/72 hours > 100 mg/L

Chronic toxicity to fish: No data available.

Chronic toxicity to invertebrates: No data available.

Toxicity to microorganisms: No data available.

Effects on terrestrial organisms: No data available.

Sediment toxicity: No data available.

Relevant information on the hazardous components:

Distillates (petroleum), hydrotreated light

Acute toxicity to fish: LC0/Oncorhynchus mykiss/96 hours > 1000 mg/L (OECD 203)

Acute toxicity to invertebrates: EC0/Daphnia magna/48 hours > 1000 mg/L (OECD 202)

Acute toxicity to algae: IC0/Pseudokirchneriella subcapitata/72 hours > 1000 mg/L (OECD 201)

Chronic toxicity to fish: NOEC/Oncorhynchus mykiss/28 days > 1000 mg/L

Chronic toxicity to invertebrates: NOEC/Daphnia magna/21 days > 1000 mg/L

Toxicity to microorganisms: EC50/Tetrahymena pyriformis/ 48h > 1000 mg/L

Effects on terrestrial organisms: No data available.

Sediment toxicity: No data available. Readily biodegradable, exposure to sediment is unlikely.

Poly(oxy-1,2-ethanediyl), a-tridecyl-w-hydroxy-, branched

Acute toxicity to fish: LC50/Cyprinus carpio/96 hours = 1 - 10 mg/L (OECD 203)

Acute toxicity to invertebrates: EC50/Daphnia/48 hours = 1 - 10 mg/L (OECD 202)

Acute toxicity to algae: IC50/Desmodesmus subspicatus/72 hours = 1 - 10 mg/L (OECD 201)

Chronic toxicity to fish: No data available.

Chronic toxicity to invertebrates: No data available.

Toxicity to microorganisms: EC10/activated sludge/17 h > 10000 mg/L (DIN 38412-8)

Effects on terrestrial organisms: No data available.

Sediment toxicity: No data available.

12.2. Persistence and degradability

Information on the product as supplied:

Degradation: Not readily biodegradable.

Hydrolysis: Does not hydrolyze.

Photolysis: No data available.

Relevant information on the hazardous components:

Distillates (petroleum), hydrotreated light

Degradation: Readily biodegradable.

Hydrolysis: Does not hydrolyse.

Photolysis: No data available.

Poly(oxy-1,2-ethanediyl), a-tridecyl-w-hydroxy-, branched

Degradation: Readily biodegradable. > 60% / 28 days (OECD 301 B)

Hydrolysis: Does not hydrolyse.

Photolysis: No data available.

12.3. Bioaccumulative potential

Information on the product as supplied:

Not bioaccumulating.

Partition co-efficient (Log Pow): -2

Bioconcentration factor (BCF): ~0

Relevant information on the hazardous components:

Distillates (petroleum), hydrotreated light

Partition co-efficient (Log Pow): 3-6

Bioconcentration factor (BCF): No data available.

Poly(oxy-1,2-ethanediyl), a-tridecyl-w-hydroxy-, branched

Partition co-efficient (Log Pow): > 3

Bioconcentration factor (BCF): No data available.

12.4. Mobility in soil

Information on the product as supplied:

No data available.

Relevant information on the hazardous components:

Distillates (petroleum), hydrotreated light

Koc: No data available.

Poly(oxy-1,2-ethanediyl), a-tridecyl-w-hydroxy-, branched

Koc: > 5000 12.5. Other adverse effects

None.

12.5. Other adverse effects

None known.

SECTION 13. Disposal considerations

13.1. Waste treatment methods

Waste from residues / unused products:

Dispose of in accordance with local regulations.

Contaminated packaging:

If recycling is not practicable, dispose of in compliance with local regulations.

Recycling:

The product and its packaging are not suitable for recycling.

SECTION 14. Transport information

Land transport (DOT)

Not classified.

Sea transport (IMDG)

Not classified.

Air transport (IATA)

Not classified.

SECTION 15. Regulatory information

15.1. Safety, health and environmental regulations/legislation specific for the substance or mixture

Information on the product as supplied: TSCA Chemical Substances Inventory:

All components of this product are either listed on the inventory or are exempt from listing.

US SARA Reporting Requirements: SARA (Section 311/312) hazard class:

Not concerned.

RCRA status :

Not RCRA hazardous.

California Proposition 65 Information:

WARNING! This product contains a chemical known to the State of California to cause cancer and birth defects or other reproductive harm, acrylamide.

SECTION 16. Other information

NFPA and HMIS Ratings: NFPA:

Health: 0

Flammability: 1

Instability: 0



HMIS:

Health: 0

Flammability: 1

Physical Hazard: 0

PPE Code: B

This data sheet contains changes from the previous version in section(s):

SECTION 1. Identification of the substance/mixture and of the company/undertaking, SECTION 2. Hazards identification, SECTION 3. Composition/information on ingredients, SECTION 4. First aid measures, SECTION 5. Fire-fighting measures, SECTION 6. Accidental release measures, SECTION 7. Handling and storage, SECTION 8. Exposure controls/personal protection, SECTION 9. Physical and chemical properties, SECTION 10. Stability and reactivity, SECTION 11. Toxicological information, SECTION 12. Ecological information, SECTION 13. Disposal considerations, SECTION 14. Transport information, SECTION 15. Regulatory information, SECTION 16. Other Information.

Key or legend to abbreviations and acronyms used in the safety data sheet:

Abbreviations

Acute Tox. 4 = Acute toxicity Category Code 4

Asp. Tox. 1 = Aspiration hazard Category Code 1

Eye Dam 1 = Serious eye damage/eye irritation Category Code 1

H-Phrases

H302 - Harmful if swallowed

H304 - May be fatal if swallowed and enters airways

H318 - Causes serious eye damage

This SDS was prepared in accordance with the following:

Federal Regulation 29 CFR 1910.1200

The information contained herein is to the best of our knowledge and belief accurate. However, since the conditions of handling and use are beyond our control, Tramfloc, Inc. makes no guarantee for results obtained, and assumes no responsibility for damages incurred by use of this product. It is the responsibility of the user to comply with all federal, state, and local laws and regulations.

MATERIAL SAFETY DATA SHEET

PRETREATED BRINE

FILE NO.:
MSDS DATE: 10/8/2015

SECTION 1: PRODUCT AND COMPANY IDENTIFICATION

PRODUCT NAME: PRETREATED BRINE
SYNONYMS: BRINE SOLUTION, PRODUCED WATER, FORMATION WATER, FRACTIONATION WATER
PRODUCT CODES: N/A

MANUFACTURER: FAIRMONT BRINE PROCESSING, LLC
DIVISION: N/A
ADDRESS: 168 AFR DRIVE | FAIRMONT, WV 26554

EMERGENCY PHONE: (412) 680-6244
CHEMTREC PHONE: (800) 424-9300 (24 HOURS)
OTHER CALLS: (304) 363-9876
FAX PHONE: (412) 231-5891

CHEMICAL NAME: BRINE SOLUTION
CHEMICAL FAMILY: MIXTURE
CHEMICAL FORMULA: MIXTURE

PRODUCT USE: EVAPORATION/ CRYSTALLIZATION
PREPARED BY: LDK

SECTION 1 NOTES: Discharge from pretreatment process (after oil removal, chemical precipitation, clarification, and filtration)

SECTION 2: COMPOSITION/INFORMATION ON INGREDIENTS

<u>INGREDIENT</u>	<u>CAS NO.</u>	<u>% WT</u>
Water	7732-18-5	80-95
Calcium chloride	10043-52-4	0-10
Potassium chloride	7447-40-7	0-10
Sodium chloride	7647-14-5	0-10
Residual metals	Various	<1
Benzene	71-43-2	<0.01

SECTION 3: HAZARDS IDENTIFICATION

EMERGENCY OVERVIEW: WARNING! Causes eye irritation. The product may contain benzene which may cause cancer and cause blood disorders.

ROUTES OF ENTRY: Eye contact. Skin contact. Ingestion. Inhalation.

POTENTIAL HEALTH EFFECTS

EYES: Causes eye irritation

SKIN: Prolonged or repeated skin contact may cause irritation.

INGESTION: May cause gastrointestinal irritation, nausea, vomiting and diarrhea

INHALATION: No inhalation hazard under normal conditions. If misting occurs: may cause mild mucous membrane irritation of the nose, throat, and upper respiratory tract.

ACUTE HEALTH HAZARDS: Causes eye irritation.

CHRONIC HEALTH HAZARDS: May contain benzene. Human epidemiology studies indicate that prolonged and/or repeated overexposure to benzene may cause damage to the blood-producing system and serious blood disorders, including leukemia. Animal tests suggest that prolonged and/or repeated overexposure to benzene may damage the embryo/fetus. The relevance of these animal studies to humans has not been fully established.

CARCINOGENICITY

This product is not considered to be a carcinogen by IARC, ACGIH, NTP, or OSHA.

OSHA:	Benzene (CAS 71-43-2)	Cancer hazard
ACGIH:	Benzene (CAS 71-43-2)	A1 Confirmed human carcinogen
NTP:	Benzene (CAS 71-43-2)	Known carcinogen
IARC:	Benzene (CAS 71-43-2)	1 Carcinogenic to humans

MATERIAL SAFETY DATA SHEET

PRETREATED BRINE

FILE NO.:
MSDS DATE: 10/8/2015

SECTION 4: FIRST AID MEASURES

EYES: In case of contact, immediately flush eyes with fresh water for at least 15 minutes while holding the eyelids open. Remove contact lenses if worn. Get medical attention if irritation persists.

SKIN: Remove contaminated clothing and shoes. Wash affected area with mild soap and water. Get medical attention if irritation develops and persists.

INGESTION: Rinse mouth thoroughly. Get medical attention if any discomfort occurs

INHALATION: If breathing is difficult, remove to fresh air and keep at rest in a position comfortable for breathing. Call a physician if symptoms develop or persist.

SECTION 4 NOTES: If you feel unwell, seek medical advice (show the label where possible). Ensure that medical personnel are aware of the material(s) involved, and take precautions to protect themselves.

SECTION 5: FIRE-FIGHTING MEASURES

FLAMMABLE PROPERTIES: This product is not flammable; however sufficient hydrocarbon vapors may accumulate from oil or natural gas condensate floating on the surface of the produced water to cause a flash fire. The fire should burn out fairly rapidly depending on the amount of oil and natural gas condensate floating on the surface of the produced water.

EXTINGUISHING MEDIA

SUITABLE EXTINGUISHING MEDIA: Dry chemical powder. Foam. Carbon dioxide (CO₂).

PROTECTION OF FIREFIGHTERS

PROTECTIVE EQUIPMENT AND PRECAUTIONS FOR FIREFIGHTERS: A fire would be associated with vapors related to oil or natural gas condensate floating on the surface of the produced water. Water maybe ineffective on flames and may even spread the fire but should be used to cool pressurized containers in the fire.

SPECIAL PROTECTIVE EQUIPMENT FOR FIREFIGHTERS:

Firefighters should wear appropriate protective equipment and self-contained breathing apparatus (SCBA) with full face-piece operated in positive pressure mode. Use approved gas detectors in confined spaces.

SPECIFIC METHODS: Promptly isolate the scene by removing persons from the vicinity of the incident if there is a fire. Do not extinguish flames at leak because of the possibility of a uncontrolled re-ignition exists. If it is safe to do so, cut off fuel supply and/or allow fire to burn out. The fire should burn out fairly rapidly depending on the amount of oil and natural gas condensate floating on the surface of the produced water. If leak or spill has not ignited, water spray or ventilation can be used to disperse the vapors.

HAZARDOUS COMBUSTION PRODUCTS: Sodium oxides. Carbon oxides.

SECTION 6: ACCIDENTAL RELEASE MEASURES

ACCIDENTAL RELEASE MEASURES: Recover by pumping (use an explosion-proof motor or hand pump) or by sand or other oil absorbing materials. Carefully shovel, scoop or sweep up into a waste container for reclamation or disposal. Where feasible and appropriate, remove contaminated soil or flush with fresh water. On water spills utilize absorbent material to remove oil and natural gas liquid from the surface of the water.

SECTION 6 NOTES: Avoid excess skin contact with spilled material.

SECTION 7: HANDLING AND STORAGE

HANDLING: Avoid contact with skin, eyes and clothing. Wash thoroughly after handling.

STORAGE: Keep containers in well-ventilated area away from flame, sparks, excessive temperatures and open flames. Keep the containers closed and clearly labeled. Empty product containers or vessels may contain vapors. Do not pressurize, cut, heat, weld or expose such containers to sources of ignition. Do not enter storage areas and confined spaces without adequate ventilation. Use appropriate respiratory protection if there is the potential to exceed the exposure limit(s). Vapors containing benzene may accumulate during storage and transport.

SECTION 8: EXPOSURE CONTROLS/PERSONAL PROTECTION

VENTILATION: Ensure adequate ventilation, especially in confined areas.

RESPIRATORY PROTECTION: No personal respiratory equipment normally required.

EYE PROTECTION: If eye contact is likely, safety glasses should be worn.

MATERIAL SAFETY DATA SHEET
PRETREATED BRINE

FILE NO.:
MSDS DATE: 10/8/2015

SECTION 8: EXPOSURE CONTROLS/PERSONAL PROTECTION (Continued)

SKIN PROTECTION: No special garments required. Wash contaminated clothing prior to reuse.

OTHER PROTECTIVE CLOTHING OR EQUIPMENT: No other protective clothing or equipment is needed.

WORK HYGIENIC PRACTICES: Always observe good personal hygiene measures, such as washing after handling the material and before eating, drinking, and/or smoking. Routinely wash work clothing and protective equipment to remove contaminants. Discard contaminated clothing and footwear that cannot be cleaned. Handle in accordance with good industrial hygiene and safety practice.

SECTION 9: PHYSICAL AND CHEMICAL PROPERTIES

APPEARANCE: Dirty colored liquid

ODOR: Faint hydrocarbon odor

PHYSICAL STATE: Liquid

pH AS SUPPLIED: 4.5-7.5
pH (Other):

BOILING POINT:

F: 212°
C: 100°

MELTING POINT:

F: N/A
C: N/A

FREEZING POINT:

F: < 32°
C: < 0°

VAPOR PRESSURE (mmHg): 13.6 (approx.)

@ F: 68°
C: 20°

VAPOR DENSITY (AIR = 1): <1

@ F: 68°
C: 20°

SPECIFIC GRAVITY (H₂O = 1): 1.2 (approx.)

@ F: 68°
C: 20°

EVAPORATION RATE: N/A

SOLUBILITY IN WATER: Complete

PERCENT SOLIDS BY WEIGHT: N/A

PERCENT VOLATILE: N/A

BY WT/ BY VOL @

F:
C:

VOLATILE ORGANIC COMPOUNDS (VOC): N/A

WITH WATER: LBS/GAL

WITHOUT WATER: LBS/GAL

MOLECULAR WEIGHT: N/A

SECTION 10: STABILITY AND REACTIVITY

STABILITY: Stable

CONDITIONS TO AVOID (STABILITY): Keep away from heat, sparks, and open flame.

HAZARDOUS DECOMPOSITION OR BY-PRODUCTS: Carbon dioxide. Water vapor. May produce oxides of sulfur. Carbon monoxide via incomplete combustion.

HAZARDOUS POLYMERIZATION: Does not occur.

CONDITIONS TO AVOID (POLYMERIZATION): N/A

MATERIAL SAFETY DATA SHEET
PRETREATED BRINE

FILE NO.:
MSDS DATE: 10/8/2015

SECTION 11: TOXICOLOGICAL INFORMATION

TOXICOLOGICAL INFORMATION: This product may contain detectable but varying quantities of the naturally occurring radioactive substance Radium 226/228. Due to the long half life of Radium 226/228 (1600yr/5.75yr), there should not be significant radiation. The solution may cause eye and skin irritation.

SECTION 12: ECOLOGICAL INFORMATION

ECOLOGICAL INFORMATION: An environmental hazard cannot be excluded in the event of unprofessional handling or disposal.

SECTION 12 NOTES: To be expected to be harmful to aquatic organisms.

SECTION 13: DISPOSAL CONSIDERATIONS

WASTE DISPOSAL METHOD: Reuse or recycle if possible. All disposal practices must be in compliance with all Federal, State/Provincial and local laws and regulations. Regulations may vary in different locations. Waste characterizations and compliance with applicable laws are the responsibility solely of the waste generator. AS YOUR SUPPLIER, WE HAVE NO CONTROL OVER THE MANAGEMENT PRACTICES OR MANUFACTURING PROCESSES OF PARTIES HANDLING OR USING THIS MATERIAL. THE INFORMATION PRESENTED HERE PERTAINS ONLY TO THE PRODUCT AS SHIPPED IN ITS INTENDED CONDITION AS DESCRIBED IN MSDS SECTION: Composition Information. FOR UNUSED & UNCONTAMINATED PRODUCT, the preferred options include sending to a licensed, permitted: Reclaimer. Waste water treatment system.

SECTION 14: TRANSPORT INFORMATION

U.S. DOT 49 CFR 172.101:

Status: Not regulated

CANADIAN TRANSPORTATION OF DANGEROUS GOODS:

Status: Not regulated

OTHER AGENCIES:

SECTION 15: REGULATORY INFORMATION

U.S. REGULATIONS

OSHA REGULATORY STATUS: This material is considered hazardous by the OSHA Hazard Communication Standard (29 CFR 1910.1200)

CERCLA SECTIONS 102a/103 HAZARDOUS SUBSTANCES (40 CFR 302.4): Not regulated.

EPCRA EXTREMELY HAZARDOUS SUBSTANCES (40 CFR 355.30): Not regulated.

EPCRA SECTIONS 311/312 HAZARD CATEGORIES (40 CFR 370.10): Acute Health Hazard

EPCRA SECTION 313 (40 CFR 372.65): To the best of our knowledge, this product does not contain chemicals at levels which require reporting under this statute.

OSHA PROCESS SAFETY (PSM) (29 CFR 1910.119): Not regulated.

STATE REGULATIONS:

INTERNATIONAL REGULATIONS:

SECTION 16: OTHER INFORMATION

IMPORTANT:

The information presented herein, while not guaranteed, was prepared by technical personnel and is true and accurate to the best of our knowledge. **NO WARRANTY OF MERCHANTABILITY OR OF FITNESS FOR A PARTICULAR PURPOSE, OR WARRANTY OR GUARANTY OF ANY OTHER KIND, EXPRESS OR IMPLIED, IS MADE REGARDING PERFORMANCE, SAFETY, SUITABILITY, STABILITY OR OTHERWISE.** This information is not intended to be all-inclusive as to the manner and conditions of use, handling, storage, disposal and other factors that may involve other or additional legal, environmental, safety or performance considerations, and OxyChem assumes no liability whatsoever for the use of or reliance upon this information. While our technical personnel will be happy to respond to questions, safe handling and use of the product remains the responsibility of the customer. No suggestions for use are intended as, and nothing herein shall be construed as, a recommendation to infringe any existing patents or to violate any Federal, State, local or foreign laws. OSHA Standard 29 CFR 1910.1200 requires that information be provided to employees regarding the hazards of chemicals by means of a hazard communication program including labeling, safety data sheets, training and access to written records. We request that you, and it is your legal duty to, make all information in this Safety Data Sheet available to your employees.



SAFETY DATA SHEET

Page 1 of 4
Revision Date: 05/26/15

1. IDENTIFICATION

Product Name: **HW 7**

Company: **Henwil Corporation**
P.O. Box 358
Newell, PA 15466
Phone: 724-938-3610 Fax: 724-938-3639

Emergency telephone number: 724-938-3610

Product Use: Silicone-based defoamer

2. HAZARDS IDENTIFICATION



Warning! May cause eye irritation. Prolonged or repeated contact with the undiluted product can cause skin dryness or irritation. Swallowing this product may cause gastrointestinal irritation, diarrhea, nausea, and vomiting.

Precautions – Do not eat, drink or smoke when using this product. Avoid contact with eyes, skin and clothing. Wear protective rubber gloves, safety goggles and protective clothing when handling. Use in well-ventilated area. Avoid breathing mist or vapor. Wash thoroughly after handling. Keep containers closed when not in use.

HMIS & NFPA Ratings:	<u>HMIS</u>	<u>NFPA</u>
Health:	0	-
Flammability:	0	-
Reactivity:	0	-
Additional information:	B	

Product Name:

HW 7

Revision Date: 05/26/2015

EFFECTS OF OVEREXPOSURE

ACUTE OVEREXPOSURE: Possible skin and eye irritation.

CHRONIC OVEREXPOSURE: None known

3. COMPOSITION / INFORMATION ON INGREDIENTS

INGREDIENTS	CAS NO.	WEIGHT%	PEL	TLV
None	-	-	-	-

Listed carcinogen by: IARC: no NTP: no OSHA: no ACGIH: no

Legend: PEL: OSHA Permissible Exposure Limit TLV: ACGIH Threshold Limit
 TD: Total dust RF: Respirable fraction
 TWA: Time Weighted Average, 8-hr NTES: None Established

4. FIRST-AID MEASURES

EYES: Immediately flush with plenty of water for at least 15 minutes, holding eyelids apart to ensure flushing of the entire surface. Washing within one minute is essential to achieve maximum effectiveness. Seek medical attention.

SKIN: Wash thoroughly with soap and water, remove contaminated clothing and footwear. Wash clothing before reuse. Get medical attention immediately.

INHALATION: Remove victim from contaminated area to fresh air immediately. Get immediate medical attention. If breathing is difficult, give oxygen. Avoid mouth-to-mouth resuscitation.

INGESTION: NA

5. FIRE-FIGHTING MEASURES

FLASH POINT: > 200 °F (TCC)

AUTOIGNITION TEMPERATURE: NA

LOWER FLAMMABILITY LIMIT: NA

UPPER FLAMMABILITY LIMIT: NA

EXTINGUISHING MEDIA: Product will not burn until water is driven off; however, use extinguishing media as appropriate for the materials in the surrounding fire. On large fires, use dry chemical, foam, or water spray

FIRE FIGHTING PROCEDURES: Water spray should be used to keep drums cool if they are involved in a fire since heat will cause the product to expand and possibly cause the drums to explode from internal pressure.

Product Name: HW 7Revision Date: 05/26/2015**6. ACCIDENTAL RELEASE MEASURES**

Contain spill and salvage as much material as possible by pumping to a salvage tank or drum. Pick up remaining material with a suitable absorbent.

7. HANDLING AND STORAGE

Store at normal temperatures and conditions of warehousing. Keep container closed when not in use. Avoid allowing product to freeze. Wash contaminated clothing before re-wearing.

8. EXPOSURE CONTROLS / PERSONAL PROTECTION

COMPONENT	OSHA PEL	ACGIH TLV
None	-	-

VENTILATION REQUIREMENTS: Local exhaust, general mechanical.

EYE PROTECTION: Chemical splash goggles and/or face shield

SKIN PROTECTION: Wear appropriate personal protective clothing, including rubber gloves, to prevent skin contact

RESPIRATORY PROTECTION: Not normally required

OTHER REQUIRED EQUIPMENT: Standard work clothing and work shoes. Safety shower and eye wash located in immediate area

9. PHYSICAL AND CHEMICAL PROPERTIES

Appearance:	Milky white, liquid emulsion
Odor:	Slight
Odor threshold:	NA
Upper/lower flammability or explosive limits:	NA
Boiling point:	212° F
Melting point/freezing point	NA
Flammability (solid, gas):	NA
Flash point:	NA
Vapor pressure:	NA
Solubility in water:	Translucent emulsion
Vapor density (air = 1):	NA
Specific gravity (water):	0.95 – 1.05
Evaporation rate:	NA
pH:	6 - 8 (neat)
Partition coefficient (n-octanol/water):	NA
Autoignition temperature:	NA
Decomposition temperature:	NA
Viscosity:	< 100 cps

Product Name:

HW 7

Revision Date: 05/26/2015

10. STABILITY AND REACTIVITY

STABLE:	Yes. Acids will cause product to become very low in viscosity which will result in separation of the product.
HAZARDOUS POLYMERIZATION:	No
CONDITIONS TO AVOID:	NA
INCOMPATIBLE MATERIALS:	Strong oxidizers. Acids will cause product to become very low in viscosity which will result in separation of the product.
DECOMPOSITION PRODUCTS:	Carbon dioxide, carbon monoxide, and various hydrocarbons may be released during a fire.

11. TOXICOLOGICAL INFORMATION

PRINCIPAL ROUTES OF EXPOSURE: Skin, eyes and respiratory tract.

Ingestion: May cause gastrointestinal irritation, nausea, vomiting and diarrhea.

Inhalation: NA

Skin Contact: Prolonged or repeated contact with the undiluted product can cause skin dryness or irritation.

Eye Contact: Product is expected to cause eye irritation.

CARCINOGENICITY STATUS: Product does not contain any components in concentrations greater than or equal to 0.1% that are listed as known or suspected carcinogens by NTP, IARC, ACGIH or OSHA.

MUTAGENICITY/GENOTOXICITY/TERATOGENICITY: NA

ACUTE TOXICITY: NA

12. ECOLOGICAL INFORMATION

Acute Toxicity

Toxicity to fish:	N / A
Toxicity to daphnia:	LC ₅₀ / Daphnia (Ceriodaphnia dubia) / 48hr = 1649.4 mg / L
Toxicity to algae:	N / A

13. DISPOSAL CONSIDERATIONS

Dispose in accordance with all applicable federal, state and local regulations. Empty containers should be taken for local recycling, recovery or waste disposal.

14. TRANSPORT INFORMATION

Not subject to DOT, IMDG, IATA regulations

Product Name: HW 7Revision Date: 05/26/2015

15. REGULATORY INFORMATION

NA

16. OTHER INFORMATION

Person to contact: Product Manager

Legend:

NA = Not available

NAPL: Not Applicable

NTES = None Established

The information provided in this Safety Data Sheet is correct to the best of our knowledge, information and belief at the date of its publication. The information given is designed only as a guide for safe handling, use, processing, storage, transportation, disposal and release, and is not to be considered a warranty or quality specification. The information relates only to the specific material designated and may not be valid for such material used in combination with any other materials or in any process unless specified in the text

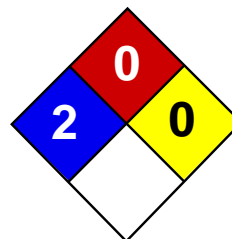

Health	2
Fire	0
Reactivity	0
Personal Protection	

Material Safety Data Sheet

Sodium Hydroxide, 25% MSDS

Section 1: Chemical Product and Company Identification

Product Name: Sodium Hydroxide, 25%

Catalog Codes: SLS4210

CAS#: Mixture.

RTECS: Not applicable.

TSCA: TSCA 8(b) inventory: Sodium hydroxide; Water

CI#: Not applicable.

Synonym:

Chemical Name: Not applicable.

Chemical Formula: Not applicable.

Contact Information:

Sciencelab.com, Inc.

14025 Smith Rd.

Houston, Texas 77396

US Sales: **1-800-901-7247**

International Sales: **1-281-441-4400**

Order Online: ScienceLab.com

CHEMTREC (24HR Emergency Telephone), call:

1-800-424-9300

International CHEMTREC, call: 1-703-527-3887

For non-emergency assistance, call: 1-281-441-4400

Section 2: Composition and Information on Ingredients

Composition:

Name	CAS #	% by Weight
Sodium hydroxide	1310-73-2	25
Water	7732-18-5	75

Toxicological Data on Ingredients: Sodium hydroxide LD50: Not available. LC50: Not available.

Section 3: Hazards Identification

Potential Acute Health Effects:

Very hazardous in case of skin contact (corrosive, irritant), of eye contact (irritant), of ingestion. Hazardous in case of inhalation. Liquid or spray mist may produce tissue damage particularly on mucous membranes of eyes, mouth and respiratory tract. Skin contact may produce burns. Inhalation of the spray mist may produce severe irritation of respiratory tract, characterized by coughing, choking, or shortness of breath. Inflammation of the eye is characterized by redness, watering, and itching. Skin inflammation is characterized by itching, scaling, reddening, or, occasionally, blistering.

Potential Chronic Health Effects:

Non-corrosive for skin. Non-irritant for skin. Non-sensitizer for skin. Non-permeator by skin. Non-irritating to the eyes. Non-hazardous in case of ingestion. Non-hazardous in case of inhalation. CARCINOGENIC EFFECTS: Not available. MUTAGENIC EFFECTS: Not available. TERATOGENIC EFFECTS: Not available. DEVELOPMENTAL TOXICITY: Not available. The substance is toxic to lungs, mucous membranes. Repeated or prolonged exposure to the substance can produce target organs damage. Repeated or prolonged contact with spray mist may produce chronic eye irritation and severe

skin irritation. Repeated or prolonged exposure to spray mist may produce respiratory tract irritation leading to frequent attacks of bronchial infection.

Section 4: First Aid Measures

Eye Contact:

Check for and remove any contact lenses. Immediately flush eyes with running water for at least 15 minutes, keeping eyelids open. Finish by rinsing thoroughly with running water to avoid a possible infection. Cold water may be used.

Skin Contact:

If the chemical got onto the clothed portion of the body, remove the contaminated clothes as quickly as possible, protecting your own hands and body. Place the victim under a deluge shower. If the chemical got on the victim's exposed skin, such as the hands : Gently and thoroughly wash the contaminated skin with running water and non-abrasive soap. Be particularly careful to clean folds, crevices, creases and groin. Cold water may be used. If irritation persists, seek medical attention. Wash contaminated clothing before reusing.

Serious Skin Contact:

Wash with a disinfectant soap and cover the contaminated skin with an anti-bacterial cream. Seek medical attention.

Inhalation: Allow the victim to rest in a well ventilated area. Seek immediate medical attention.

Serious Inhalation:

Evacuate the victim to a safe area as soon as possible. Loosen tight clothing such as a collar, tie, belt or waistband. If breathing is difficult, administer oxygen. If the victim is not breathing, perform mouth-to-mouth resuscitation. **WARNING:** It may be hazardous to the person providing aid to give mouth-to-mouth resuscitation when the inhaled material is toxic, infectious or corrosive. Seek immediate medical attention.

Ingestion:

Do not induce vomiting. Loosen tight clothing such as a collar, tie, belt or waistband. If the victim is not breathing, perform mouth-to-mouth resuscitation. Seek immediate medical attention.

Serious Ingestion: Not available.

Section 5: Fire and Explosion Data

Flammability of the Product: Non-flammable.

Auto-Ignition Temperature: Not applicable.

Flash Points: Not applicable.

Flammable Limits: Not applicable.

Products of Combustion: Not available.

Fire Hazards in Presence of Various Substances: Not applicable.

Explosion Hazards in Presence of Various Substances:

Risks of explosion of the product in presence of mechanical impact: Not available. Risks of explosion of the product in presence of static discharge: Not available.

Fire Fighting Media and Instructions: Not applicable.

Special Remarks on Fire Hazards: Not available.

Special Remarks on Explosion Hazards: Not available.

Section 6: Accidental Release Measures

Small Spill:

Dilute with water and mop up, or absorb with an inert dry material and place in an appropriate waste disposal container. If necessary: Neutralize the residue with a dilute solution of acetic acid.

Large Spill:

Corrosive liquid. Stop leak if without risk. Absorb with DRY earth, sand or other non-combustible material. Do not get water inside container. Do not touch spilled material. Use water spray curtain to divert vapor drift. Prevent entry into sewers, basements or confined areas; dike if needed. Call for assistance on disposal. Neutralize the residue with a dilute solution of acetic acid. Be careful that the product is not present at a concentration level above TLV. Check TLV on the MSDS and with local authorities.

Section 7: Handling and Storage

Precautions:

Keep container dry. Do not breathe gas/fumes/ vapour/spray. Never add water to this product In case of insufficient ventilation, wear suitable respiratory equipment If you feel unwell, seek medical attention and show the label when possible. Avoid contact with skin and eyes Keep away from incompatibles such as acids.

Storage:

Alkalis may be stored in heavy duty gauge steel containers. Corrosive materials should be stored in a separate safety storage cabinet or room.

Section 8: Exposure Controls/Personal Protection

Engineering Controls:

Provide exhaust ventilation or other engineering controls to keep the airborne concentrations of vapors below their respective threshold limit value.

Personal Protection:

Face shield. Full suit. Vapor respirator. Be sure to use an approved/certified respirator or equivalent. Gloves. Boots.

Personal Protection in Case of a Large Spill:

Splash goggles. Full suit. Vapor respirator. Boots. Gloves. A self contained breathing apparatus should be used to avoid inhalation of the product. Suggested protective clothing might not be sufficient; consult a specialist BEFORE handling this product.

Exposure Limits:

Sodium hydroxide CEIL: 2 (mg/m3) from ACGIH [1995] Consult local authorities for acceptable exposure limits.

Section 9: Physical and Chemical Properties

Physical state and appearance: Liquid.

Odor: Odorless.

Taste: Alkaline. Bitter. (Strong.)

Molecular Weight: Not applicable.

Color: Clear Colorless.

pH (1% soln/water): Basic.

Boiling Point: The lowest known value is 100°C (212°F) (Water).

Melting Point: Not available.

Critical Temperature: Not available.

Specific Gravity: Weighted average: 1.15 (Water = 1)

Vapor Pressure: The highest known value is 17.535 mm of Hg (@ 20°C) (Water).

Vapor Density: The highest known value is 0.62 (Air = 1) (Water).

Volatility: Not available.

Odor Threshold: Not available.

Water/Oil Dist. Coeff.: Not available.

Ionicity (in Water): Not available.

Dispersion Properties: See solubility in water.

Solubility: Easily soluble in cold water.

Section 10: Stability and Reactivity Data

Stability: The product is stable.

Instability Temperature: Not available.

Conditions of Instability: Not available.

Incompatibility with various substances: Extremely reactive or incompatible with acids.

Corrosivity:

Highly corrosive in presence of aluminum. Slightly corrosive to corrosive in presence of glass.

Special Remarks on Reactivity: Not available.

Special Remarks on Corrosivity: Not available.

Polymerization: No.

Section 11: Toxicological Information

Routes of Entry: Eye contact. Inhalation. Ingestion.

Toxicity to Animals:

LD50: Not available. LC50: Not available.

Chronic Effects on Humans: The substance is toxic to lungs, mucous membranes.

Other Toxic Effects on Humans:

Very hazardous in case of skin contact (corrosive, irritant), of ingestion. Hazardous in case of inhalation.

Special Remarks on Toxicity to Animals: Not available.

Special Remarks on Chronic Effects on Humans: Not available.

Special Remarks on other Toxic Effects on Humans: Not available.

Section 12: Ecological Information

Ecotoxicity: Not available.

BOD5 and COD: Not available.

Products of Biodegradation:

Possibly hazardous short term degradation products are not likely. However, long term degradation products may arise.

Toxicity of the Products of Biodegradation: The product itself and its products of degradation are not toxic.

Special Remarks on the Products of Biodegradation: Not available.

Section 13: Disposal Considerations

Waste Disposal:

Section 14: Transport Information

DOT Classification: CLASS 8: Corrosive liquid.

Identification: : Sodium hydroxide, solution (Sodium hydroxide) : UN1824 PG: II

Special Provisions for Transport: Not available.

Section 15: Other Regulatory Information

Federal and State Regulations:

Pennsylvania RTK: Sodium hydroxide Massachusetts RTK: Sodium hydroxide TSCA 8(b) inventory: Sodium hydroxide; Water

Other Regulations: OSHA: Hazardous by definition of Hazard Communication Standard (29 CFR 1910.1200).

Other Classifications:

WHMIS (Canada):

CLASS D-2A: Material causing other toxic effects (VERY TOXIC). CLASS E: Corrosive liquid.

DSCL (EEC): R35- Causes severe burns.

HMIS (U.S.A.):

Health Hazard: 2

Fire Hazard: 0

Reactivity: 0

Personal Protection:

National Fire Protection Association (U.S.A.):

Health: 2

Flammability: 0

Reactivity: 0

Specific hazard:

Protective Equipment:

Gloves. Full suit. Vapor respirator. Be sure to use an approved/certified respirator or equivalent. Wear appropriate respirator when ventilation is inadequate. Face shield.

Section 16: Other Information

References: Not available.

Other Special Considerations: Not available.

Created: 10/10/2005 12:05 PM

Last Updated: 05/21/2013 12:00 PM

The information above is believed to be accurate and represents the best information currently available to us. However, we make no warranty of merchantability or any other warranty, express or implied, with respect to such information, and we assume

no liability resulting from its use. Users should make their own investigations to determine the suitability of the information for their particular purposes. In no event shall ScienceLab.com be liable for any claims, losses, or damages of any third party or for lost profits or any special, indirect, incidental, consequential or exemplary damages, howsoever arising, even if ScienceLab.com has been advised of the possibility of such damages.

ISOPLUS

MSDS ID: 02450

I. CHEMICAL PRODUCT AND COMPANY IDENTIFICATION

Product Name: ISOPLUS

Product Descriptor: BOILER TREATMENT COMPOUND

MANUFACTURER: DUBOIS CHEMICALS, INC.

EMERGENCY PHONE NUMBER: (866) 923-4919

3630 E. KEMPER ROAD

CINCINNATI, OH. 45241

II. HAZARDOUS COMPONENTS

Component Name	CAS Number	%	Exposure Limits	Units
POTASSIUM METABISULFITE	16731-55-8	5 - 15%	None established	
POTASSIUM SULFITE	10117-38-7	5 - 15%	None established	
SODIUM METABISULFITE	7681-57-4	5 - 15%	TLV 5	MG/M3
SODIUM SULFITE (7757-83-7)		5 - 15%	None established	

III. HAZARDS IDENTIFICATION

EMERGENCY OVERVIEW:

WARNING - Contains chemicals that cause irritation to eyes and skin. May be harmful if swallowed. Wear eye protection, clothing and rubber gloves to prevent prolonged skin contact. Wash after handling.

POSSIBLE ROUTES OF ENTRY: Inhalation and ingestion.

SIGNS AND SYMPTOMS OF OVEREXPOSURE

ACUTE: EYES: Causes eye irritation. SKIN: Causes skin irritation.

INGESTION: If swallowed, may cause gastric distress, diarrhea, vomiting and possible depression of the central nervous system (CNS). INHALATION: May cause irritation of respiratory tract.

CHRONIC: Same as acute effects.

MEDICAL CONDITIONS GENERALLY AGGRAVATED BY EXPOSURE: Dermatitis, sensitive skin, pulmonary function and asthma.

TARGET ORGAN(S) OF CHEMICAL HAZARD(S): Eyes, skin, respiratory tract, and gastrointestinal tract.

IV. FIRST AID MEASURES

EYES: Immediately flush eyes with plenty of water for 15 minutes. Get medical attention.

SKIN: Flush skin with plenty of water and wash with mild soap. If irritation develops, get medical attention.

INGESTION: If swallowed, rinse mouth with water. Dilute by drinking several glasses of water. DO NOT induce vomiting. If patient vomits, rerinse mouth. Get immediate medical attention. NOTE: Never give fluids by mouth to an unconscious person.

INHALATION: Remove to fresh air and seek medical attention.

ISOPLUS

MSDS ID: 02450

V. FIRE FIGHTING MEASURES

FLASH POINT (degrees F): NONE FLAME EXTENSION: N/A
FLAMMABLE LIMITS IN AIR BY VOLUME: LEL: NONE UEL: NONE
UNUSUAL FIRE OR EXPLOSIVE HAZARDS: Toxic fumes or vapor may form during fire.
EXTINGUISHING MEDIA: Water, water spray, CO2, foam or dry powder.
FIRE FIGHTING INSTRUCTIONS: Wear full protective gear and positive pressure breathing apparatus (SCBA) in fire area.
SPECIAL INSTRUCTIONS: Spilled product may cause slippery surface and fall hazard.

VI. ACCIDENTAL RELEASE MEASURES

IF MATERIAL IS RELEASED OR SPILLED:
Flush small amounts to drain. Collect and return large amounts to container.
This product does not contain a reportable quantity (RQ) under CERCLA.

VII. HANDLING AND STORAGE

HANDLING AND STORAGE PRECAUTIONS: Store in a cool, dry area, keep away from acids. Keep container closed when not in use. Wear protective gear when handling or using. Do not pressurize container to empty.

VIII. EXPOSURE CONTROLS/PERSONAL PROTECTION

EYE/FACE PROTECTION: Safety glasses with side shields. Chemical goggles if contact or splash hazard exists.
PROTECTIVE GLOVES: Liquid proof gloves.
RESPIRATORY PROTECTION: Product does not have any established exposure limits. NIOSH/MSHA approved respirator recommended in enclosed or confined spaces where high air concentration or long exposure may occur.
OTHER PROTECTIVE CLOTHING/EQUIPMENT: Chemical apron.
ENGINEERING CONTROLS:
VENTILATION: Good general ventilation should be sufficient to control airborne levels.

IX. PHYSICAL AND CHEMICAL PROPERTIES

APPEARANCE AND ODOR: Clear liquid, mild odor.

BOILING POINT (DEG F): 215 FREEZING POINT: 20 F
SPECIFIC GRAVITY/BULK DENSITY: 1.25
pH: 7.3 pH 1% SOLUTION: 7.0
VOLATILE BY VOLUME: 72
SOLUBILITY IN WATER: Soluble
VAPOR PRESSURE(mmHg): 17.5 at 20 C VAPOR DENSITY: 17.3

ISOPLUS

MSDS ID: 02450

X. STABILITY AND REACTIVITY

CHEMICAL STABILITY: STABLE

INCOMPATIBILITY WITH OTHER MATERIALS: Acids

HAZARDOUS DECOMPOSITION PRODUCTS: Incomplete combustion forms; oxides of sulfur; oxides of carbon

HAZARDOUS POLYMERIZATION: None known.

XI. TOXICOLOGICAL INFORMATION

TOXICOLOGICAL TESTING: Toxicological testing has not been performed on the product. Listed below is the available toxicology test data for components of the product.

TOXICITY TEST DATA:

Sodium Metabisulfite:

Oral LD50	(rat)	>2 gm/kg
Dermal LD50	(rat)	>2 gm/kg
Intravenous LD50	(rat)	115 mg/kg
Parenteral LD50	(rat)	910 mg/kg

XII. ECOLOGICAL INFORMATION

Toxicological testing has not been performed on the product. Listed below is the available toxicology test data for components of the product.

ECOTOXICITY TEST DATA:

Sodium Metabisulfite:

LC50 (96 hr) (Gambusia affinis) 120 mg/l

ENVIRONMENTAL FATE: No data available.

XIII. DISPOSAL CONSIDERATIONS

RCRA REGULATED: Not Regulated.

Discharge diluted product to industrial sewer in accordance with discharge permit or local POTW regulations. Use product in container until empty. Rinse container with water. Recycle or dispose of container according to product labeling or governmental regulations.

XIV. TRANSPORT INFORMATION

Please refer to the Bill of Lading/receiving documents for up to date shipping information.

XV. REGULATORY INFORMATION

U.S. Federal Regulations:

TSCA: All ingredients in this product are on TSCA inventory.

HAPS: NONE

VOC CONTENT (EPA Method 24A): % VOC: 0 Lb/Gal VOC: 0

CERCLA/EPCRA:

Section 313 Toxic Chemicals:

NONE

SARA Section 311/312:

ISOPLUS

MSDS ID: 02450

XV. REGULATORY INFORMATION (Cont.)

ACUTE: YES CHRONIC: NO FIRE: NO REACTIVITY: NO
SUDDEN RELEASE OF PRESSURE: NO

LISTED CARCINOGEN: NONE

NTP: NO IARC: NO OSHA: NO

HMIS RATINGS: HEALTH: 2 FIRE: 0 REACTIVITY: 0

PERSONAL PROTECTIVE EQUIPMENT: C

NFPA RATING: HEALTH: 2 FIRE: 0 REACTIVITY: 0 SPECIAL: IRRITANT

STATE RIGHT-TO-KNOW INFORMATION:

SODIUM SULFITE - CAS #7757-83-7

WATER - CAS #7732-18-5

POTASSIUM SULFITE - CAS #10117-38-1

SODIUM METABISULFITE - CAS #7681-57-4

POTASSIUM METABISULFITE - CAS #16731-55-8

CALIFORNIA PROPOSITION 65:

None of the ingredients are on the California proposition 65 list.

XVI. OTHER INFORMATION

Disclaimer: The information contained in this material safety data sheet is based on the knowledge of this specific product and current national legislation. It applies to the product as sold, use dilutions may be less hazardous. It may not be valid for this material if used in combination with any other materials or in a process. It is the user's responsibility to evaluate the handling, and use.



CONDEN-SAF 4675

HMIS		NFPA	Personal protective equipment		
Health	3	3	  		
Fire Hazard	2	2			
Reactivity	0	0			

Version Number: 2

Preparation date: 2008-12-01

1. PRODUCT AND COMPANY IDENTIFICATION

Product name: CONDEN-SAF 4675
MSDS #: MS0100823
Product Code: 00632070, 00632150, 00632470
Recommended use: Condensate line corrosion inhibitor .

Manufacturer, importer, supplier:
 DuBois Chemicals, Inc. Canadian Headquarters
 3630 E. Kemper Rd. DuBois Chemicals Canada, Inc.
 Cincinnati, OH 45241 3450 Ridgeway Drive, Unit 2
 Phone: 1-800-438-2647 Mississauga, Ontario L5L 0A2
 Phone: 1-866-861-3603

Emergency telephone number: 1-866-923-4919 (US and Canada); 01-651-523-0314 (Int'l and México)

2. HAZARDS IDENTIFICATION

EMERGENCY OVERVIEW

DANGER. CORROSIVE. CAUSES SKIN AND EYE BURNS. HARMFUL OR FATAL IF SWALLOWED. COMBUSTIBLE LIQUID AND VAPOR.

Principle routes of exposure: Eye contact. Skin contact. Inhalation. Ingestion.
Eye contact: Corrosive. Causes permanent eye damage, including blindness.
Skin contact: Corrosive. Causes permanent damage.
Inhalation: May cause irritation and corrosive effects to nose, throat and respiratory tract.
Ingestion: Corrosive. Causes burns to mouth, throat and stomach.

3. COMPOSITION/INFORMATION ON INGREDIENTS

Hazardous ingredients

Ingredient(s)	CAS #	Weight %	LD50 Oral - Rat (mg/kg)	LD50 Dermal - Rabbit	LC50 Inhalation - Rat
Morpholine	110-91-8	10 - 20%	1050	=310 mg/kg	8000 ppm (8h)
Diethylaminoethanol	100-37-8	10 - 20%	1300	=1260 mg/kg	Not available
Cyclohexylamine	108-91-8	10 - 20%	11	=208 mg/kg	>0.7 mg/L (4 h) >1.5 mg/L (1 h)

4. FIRST AID MEASURES

Eye contact: Immediately flush eyes with running water for at least 15-20 minutes, keeping eyelids open. Get medical attention immediately.
Skin contact: Flush immediately with plenty of water for at least 15-20 minutes. Get medical attention immediately.
Inhalation: If breathing is affected, remove to fresh air. Get medical attention immediately.
Ingestion: If swallowed, give a cupful of water or milk. THEN IMMEDIATELY CONTACT A PHYSICIAN OR POISON CENTER. DO NOT induce vomiting unless directed to do so by medical personnel. Never give anything by mouth to an unconscious person.
Aggravated Medical Conditions: Individuals with chronic respiratory disorders such as asthma, chronic bronchitis, emphysema, etc., may be more susceptible to irritating effects.

5. FIRE-FIGHTING MEASURES

Suitable extinguishing media: Dry chemical, water spray, foam, carbon dioxide.
Specific hazards: Keep product and empty container away from heat and sources of ignition.
Unusual hazards: None known
Specific methods: No special methods required

5. FIRE-FIGHTING MEASURES

Special protective equipment for firefighters: As in any fire, wear self-contained breathing apparatus pressure-demand, MSHA/NIOSH (approved or equivalent) and full protective gear

Extinguishing media which must not be used for safety reasons: No information available

6. ACCIDENTAL RELEASE MEASURES

Personal precautions:

Contaminated surfaces will be extremely slippery. Use personal protective equipment.

Environmental precautions and clean-up methods:

Clean-up methods - large spillage. Prevent product from entering drains. Absorb spill with inert material (e.g. dry sand or earth), then place in a chemical waste container. Use a water rinse for final clean-up.

7. HANDLING AND STORAGE

Handling:

Avoid contact with skin, eyes and clothing. Do not taste or swallow. Avoid breathing vapors or mists. Use only with adequate ventilation. Remove and wash contaminated clothing and footwear before re-use. Wash thoroughly after handling. Product residue may remain on/in empty containers. All precautions for handling the product must be used in handling the empty container and residue. FOR COMMERCIAL AND INDUSTRIAL USE ONLY.

Storage:

Protect from freezing. Keep tightly closed in a dry, cool and well-ventilated place. Keep away from heat. KEEP OUT OF REACH OF CHILDREN.

8. EXPOSURE CONTROLS / PERSONAL PROTECTION

Engineering measures to reduce exposure:

Good general ventilation should be sufficient to control airborne levels.

Personal Protective Equipment

Eye protection:

Chemical-splash goggles.

Hand protection:

Chemical-resistant gloves

Skin and body protection:

Protective footwear. If major exposure is possible, wear suitable protective clothing and footwear.

Respiratory protection:

In case of insufficient ventilation wear suitable respiratory equipment. A respiratory protection program that meets OSHA's 29 CFR 1910.134 and ANSI Z88.2 requirements must be followed whenever workplace conditions warrant a respirator's use.

Hygiene measures:

Handle in accordance with good industrial hygiene and safety practice

Ingredient(s)	CAS #	ACGIH	OSHA	Mexico
Morpholine	110-91-8	20 ppm (TWA)	Skin 20 ppm (TWA) 70 mg/m ³ (TWA)	105 mg/m ³ (STEL) 30 ppm (STEL) 70 mg/m ³ (TWA) 20 ppm (TWA)
Diethylaminoethanol	100-37-8	2 ppm (TWA)	Skin 10 ppm (TWA) 50 mg/m ³ (TWA)	10 ppm (TWA) 50 mg/m ³ (TWA)
Cyclohexylamine	108-91-8	10 ppm (TWA)		40 mg/m ³ (TWA) 10 ppm (TWA)

9. PHYSICAL AND CHEMICAL PROPERTIES

Physical State: Liquid

pH: 12

Appearance: Liquid

Color: Clear

Odor: Amine

Specific gravity: 0.995 g/mL

Density: 8.3 lbs/gal

VOC: 40% *

Flash point: 145°F 97.5°C

Solubility: completely soluble

Viscosity: No information available

Bulk density: No information available

Dilution pH: 10.9

Vapor density: No information available

Evaporation Rate: No information available

Boiling point/range: <200°F >100°C

Melting point/range: Not determined

Decomposition temperature: Not determined

Autoignition temperature: No information available

Partition coefficient (n-octanol/water): No information available

Solubility in other solvents: No information available

Elemental Phosphorus: 0 %P

* - Title 17, California Code of Regulations, Division 3, Chapter 1, Subchapter 8.5, Article 2, Consumer Products, Sections 94508

10. STABILITY AND REACTIVITY

Stability:

Stable.

Polymerization:

Hazardous polymerization does not occur

Hazardous decomposition products:

None reasonably foreseeable.

11. TOXICOLOGICAL INFORMATION

11. TOXICOLOGICAL INFORMATION

Acute toxicity:	Oral LD50 estimated to be between 500 - 2000 mg/kg. Corrosive.
Component Information:	See Section 3
Chronic toxicity:	None known
Specific effects	
Carcinogenic effects:	None known
Mutagenic effects:	None known
Reproductive toxicity:	None known
Target organ effects:	None known

Hazardous ingredients

Ingredient(s)	CAS #	NTP	IARC	OSHA
Cyclohexylamine	108-91-8		3	

12. ECOLOGICAL INFORMATION

Environmental Information: No data available

13. DISPOSAL CONSIDERATIONS

Waste from residues / unused products:

Undiluted product is regulated under environmental and transportation laws as a corrosive waste. Dispose of according to all federal, state and local applicable regulations.

RCRA Hazard Class: D002

14. TRANSPORT INFORMATION

DOT/TDG: Please refer to the Bill of Lading/receiving documents for up to date shipping information

15. REGULATORY INFORMATION

International Inventories

All components of this product are listed on the following inventories: U.S.A. (TSCA), Canada (DSL/NDSL), Europe (EINECS/ELINCS/NLP), Australia (AICS), Korea (ECL), Japan (ENCS), Philippines (PICCS), New Zealand (NZIoC), China (IECSC).

U.S. Regulations

California Proposition 65: This product is not subject to the reporting requirements under California's Proposition 65

STATE RIGHT TO KNOW

Ingredient(s)	CAS #	MARTK:	NJRTK:	PARTK:	RIRTK:
Morpholine	110-91-8	X	X	X	X
Water	7732-18-5	-	-	-	-
Diethylaminoethanol	100-37-8	X	X	X	X
Cyclohexylamine	108-91-8	X	X	X	X

CERCLA/ SARA

Ingredient(s)	CAS #	Weight %	CERCLA/SARA RQ (lbs)	Section 302 TPQ (lbs)	Section 313
Cyclohexylamine	108-91-8	10 - 20%		10000	

SARA 311/312 Hazard Categories

Immediate:	X
Delayed:	-
Fire:	X
Reactivity:	-
Sudden Release of Pressure:	-

Canada

WHMIS hazard class: E Corrosive material , B3 Combustible liquid .



16. OTHER INFORMATION

Reason for revision: Not applicable
Prepared by: NAPRAC
Additional advice: None

16. OTHER INFORMATION

Notice to Reader: This document has been prepared using data from sources considered technically reliable. It does not constitute a warranty, express or implied, as to the accuracy of the information contained within. Actual conditions of use and handling are beyond seller's control. User is responsible to evaluate all available information when using product for any particular use and to comply with all Federal, State, Provincial and Local laws and regulations.

Material Safety Data Sheet



DUBOIS OH 50

1. Product and company identification

Product name : DUBOIS OH 50
Supplier/Manufacturer : DuBois Chemicals, Inc.
3630 E. Kemper Rd.
Cincinnati, OH 45241 USA
Phone: 1-800-438-2647

DuBois Chemicals Canada, Inc.
1155 North Service Road West
Unit 6
Oakville, Ontario, L6M 3E3 Canada
Phone: 1-866-861-3603

Recommended use : Industrial applications: Alkaline Cleaner ADDITIVE
MSDS # : MS0127133
Product code : 11728470, 11728300
Validation date : 12/12/2011.
Version : 1
Responsible name : Regulatory Department 1-800-438-2647
In case of emergency : 1-866-923-4919 (US and Canada)
01-651-523-0314 (Int'l and Mexico)

Hazardous Material Information System (U.S.A.)

Health	*	3
Flammability		0
Physical hazards		1

2. Hazards identification

Physical state : Liquid.
OSHA/HCS status : This material is considered hazardous by the OSHA Hazard Communication Standard (29 CFR 1910.1200).
Emergency overview : DANGER!
CORROSIVE. CAUSES DIGESTIVE TRACT, EYE AND SKIN BURNS.
Do not breathe vapor or mist. Do not ingest. Do not get in eyes or on skin or clothing. Use only with adequate ventilation. Keep container tightly closed and sealed until ready for use. Wash thoroughly after handling.
Routes of entry : Dermal contact. Eye contact. Inhalation.
Potential acute health effects
Inhalation : May give off gas, vapor or dust that is very irritating or corrosive to the respiratory system.
Ingestion : Corrosive to the digestive tract. Causes burns.
Skin : Corrosive to the skin. Causes burns.
Eyes : Corrosive to eyes. Causes burns.
Potential chronic health effects
Carcinogenicity : No known significant effects or critical hazards.
Target organs : Contains material which may cause damage to the following organs: upper respiratory tract, skin, eye, lens or cornea, stomach.

2. Hazards identification

Medical conditions aggravated by over-exposure : Pre-existing disorders involving any target organs mentioned in this MSDS as being at risk may be aggravated by over-exposure to this product.

See toxicological information (section 11)

3. Composition/information on ingredients

Name	CAS number	% by weight
sodium hydroxide	1310-73-2	40 - 50
sodium chloride	7647-14-5	1 - 5

There are no additional ingredients present which, within the current knowledge of the supplier and in the concentrations applicable, are classified as hazardous to health or the environment and hence require reporting in this section.

4. First aid measures

- Eye contact** : Check for and remove any contact lenses. Immediately flush eyes with plenty of water for at least 15 minutes, occasionally lifting the upper and lower eyelids. Get medical attention immediately.
- Skin contact** : In case of contact, immediately flush skin with plenty of water for at least 15 minutes while removing contaminated clothing and shoes. Wash clothing before reuse. Clean shoes thoroughly before reuse. Get medical attention immediately.
- Inhalation** : Move exposed person to fresh air. If not breathing, if breathing is irregular or if respiratory arrest occurs, provide artificial respiration or oxygen by trained personnel. Loosen tight clothing such as a collar, tie, belt or waistband. Get medical attention immediately.
- Ingestion** : Wash out mouth with water. Do not induce vomiting unless directed to do so by medical personnel. Never give anything by mouth to an unconscious person. Get medical attention immediately.
- Protection of first-aiders** : No action shall be taken involving any personal risk or without suitable training. If it is suspected that fumes are still present, the rescuer should wear an appropriate mask or self-contained breathing apparatus. It may be dangerous to the person providing aid to give mouth-to-mouth resuscitation. Wash contaminated clothing thoroughly with water before removing it, or wear gloves.
- Notes to physician** : No specific treatment. Treat symptomatically. Contact poison treatment specialist immediately if large quantities have been ingested or inhaled.

5. Fire-fighting measures

Flammability of the product : In a fire or if heated, a pressure increase will occur and the container may burst.

Extinguishing media

Suitable : Use an extinguishing agent suitable for the surrounding fire.

Not suitable : None known.

Special exposure hazards : Promptly isolate the scene by removing all persons from the vicinity of the incident if there is a fire. No action shall be taken involving any personal risk or without suitable training.

Hazardous thermal decomposition products : Decomposition products may include the following materials:
halogenated compounds
metal oxide/oxides

Special protective equipment for fire-fighters : Fire-fighters should wear appropriate protective equipment and self-contained breathing apparatus (SCBA) with a full face-piece operated in positive pressure mode.

6. Accidental release measures

- Personal precautions** : No action shall be taken involving any personal risk or without suitable training. Evacuate surrounding areas. Keep unnecessary and unprotected personnel from entering. Do not touch or walk through spilled material. Do not breathe vapor or mist. Provide adequate ventilation. Wear appropriate respirator when ventilation is inadequate. Put on appropriate personal protective equipment (see section 8).
- Environmental precautions** : Avoid dispersal of spilled material and runoff and contact with soil, waterways, drains and sewers. Inform the relevant authorities if the product has caused environmental pollution (sewers, waterways, soil or air).
- Methods for cleaning up**
- Small spill** : Stop leak if without risk. Move containers from spill area. Dilute with water and mop up if water-soluble. Alternatively, or if water-insoluble, absorb with an inert dry material and place in an appropriate waste disposal container. Dispose of via a licensed waste disposal contractor.
- Large spill** : Stop leak if without risk. Move containers from spill area. Approach release from upwind. Prevent entry into sewers, water courses, basements or confined areas. Wash spillages into an effluent treatment plant or proceed as follows. Contain and collect spillage with non-combustible, absorbent material e.g. sand, earth, vermiculite or diatomaceous earth and place in container for disposal according to local regulations (see section 13). Dispose of via a licensed waste disposal contractor. Contaminated absorbent material may pose the same hazard as the spilled product. Note: see section 1 for emergency contact information and section 13 for waste disposal.

7. Handling and storage

- Handling** : Put on appropriate personal protective equipment (see section 8). Eating, drinking and smoking should be prohibited in areas where this material is handled, stored and processed. Workers should wash hands and face before eating, drinking and smoking. Do not get in eyes or on skin or clothing. Do not breathe vapor or mist. Do not ingest. If during normal use the material presents a respiratory hazard, use only with adequate ventilation or wear appropriate respirator. Keep in the original container or an approved alternative made from a compatible material, kept tightly closed when not in use. Keep away from acids. Empty containers retain product residue and can be hazardous. Do not reuse container.
- Storage** : Store in accordance with local regulations. Store in original container protected from direct sunlight in a dry, cool and well-ventilated area, away from incompatible materials (see section 10) and food and drink. Separate from acids. Keep container tightly closed and sealed until ready for use. Containers that have been opened must be carefully resealed and kept upright to prevent leakage. Do not store in unlabeled containers. Use appropriate containment to avoid environmental contamination.

8. Exposure controls/personal protection

Occupational exposure limits

Ingredient	Exposure limits
sodium hydroxide	ACGIH TLV (United States, 2/2010). C: 2 mg/m ³ OSHA PEL (United States, 6/2010). TWA: 2 mg/m ³ 8 hour(s).

Consult local authorities for acceptable exposure limits.

- Recommended monitoring procedures** : If this product contains ingredients with exposure limits, personal, workplace atmosphere or biological monitoring may be required to determine the effectiveness of the ventilation or other control measures and/or the necessity to use respiratory protective equipment.
- Engineering measures** : If user operations generate dust, fumes, gas, vapor or mist, use process enclosures, local exhaust ventilation or other engineering controls to keep worker exposure to airborne contaminants below any recommended or statutory limits.

8. Exposure controls/personal protection

Hygiene measures : Wash hands, forearms and face thoroughly after handling chemical products, before eating, smoking and using the lavatory and at the end of the working period. Appropriate techniques should be used to remove potentially contaminated clothing. Wash contaminated clothing before reusing. Ensure that eyewash stations and safety showers are close to the workstation location.

Personal protection

Respiratory : Use a properly fitted, air-purifying or air-fed respirator complying with an approved standard if a risk assessment indicates this is necessary. Respirator selection must be based on known or anticipated exposure levels, the hazards of the product and the safe working limits of the selected respirator.

Hands : Chemical-resistant, impervious gloves complying with an approved standard should be worn at all times when handling chemical products if a risk assessment indicates this is necessary.

Recommended: nitrile rubber

Eyes : Safety eyewear complying with an approved standard should be used when a risk assessment indicates this is necessary to avoid exposure to liquid splashes, mists or dusts. Recommended: splash goggles

Skin : Personal protective equipment for the body should be selected based on the task being performed and the risks involved and should be approved by a specialist before handling this product.

Environmental exposure controls : Emissions from ventilation or work process equipment should be checked to ensure they comply with the requirements of environmental protection legislation. In some cases, fume scrubbers, filters or engineering modifications to the process equipment will be necessary to reduce emissions to acceptable levels.

Personal protective equipment (Pictograms) :

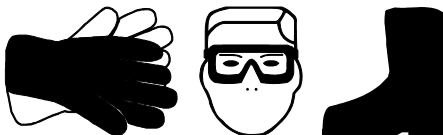

9. Physical and chemical properties

Physical state : Liquid.

Flash point : Closed cup: >93.333°C (>200°F) [Pensky-Martens.]

Color : Colorless.

Odor : Not available.

pH : >13.5

Dilution pH : >13 [Conc. (% w/w): 1%]

Boiling/condensation point : Not available.

Melting/freezing point : Not available.

Specific gravity : 1.53

Density : 12.76785 lbs/gal

Vapor pressure : Not available.

Vapor density : Not available.

Odor threshold : Not available.

Evaporation rate : Not available.

Solubility : Easily soluble in the following materials: cold water and hot water.

Elemental Phosphorus : 0 %

Octanol/water partition coefficient : Not available.

10. Stability and reactivity

- Chemical stability** : The product is stable.
- Conditions to avoid** : No specific data.
- Materials to avoid** : Reactive or incompatible with the following materials:
acids
- Hazardous decomposition products** : Under normal conditions of storage and use, hazardous decomposition products should not be produced.
- Possibility of hazardous reactions** : Under normal conditions of storage and use, hazardous reactions will not occur.

11. Toxicological information

Acute toxicity

Product/ingredient name	Result	Species	Dose	Exposure
sodium chloride	LD50 Oral	Rat	3000 mg/kg	-

Carcinogenicity

None known.

Acute toxicity estimates

Not available.

12. Ecological information

- Ecotoxicity** : No known significant effects or critical hazards.

Aquatic ecotoxicity

None known.

13. Disposal considerations

- Waste disposal** : The generation of waste should be avoided or minimized wherever possible. Empty containers or liners may retain some product residues. This material and its container must be disposed of in a safe way. Dispose of surplus and non-recyclable products via a licensed waste disposal contractor. Disposal of this product, solutions and any by-products should at all times comply with the requirements of environmental protection and waste disposal legislation and any regional local authority requirements. Avoid dispersal of spilled material and runoff and contact with soil, waterways, drains and sewers.

- RCRA classification** : D002 [corrosive]

Disposal should be in accordance with applicable regional, national and local laws and regulations.

Refer to Section 7: HANDLING AND STORAGE and Section 8: EXPOSURE CONTROLS/PERSONAL PROTECTION for additional handling information and protection of employees.

14. Transport information

IATA/IMDG/DOT/TDG: Please refer to the Bill of Lading/receiving documents for up to date shipping information.

15. Regulatory information

United States

- U.S. Federal regulations** : **TSCA 12(b) one-time export**: No products were found.
TSCA 12(b) annual export notification: No products were found.

- United States inventory (TSCA 8b)** : All components are listed or exempted.

SARA 311/312 MSDS distribution - chemical inventory - hazard identification:
DUBOIS OH 50: reactive, Immediate (acute) health hazard

SARA 302/304/311/312 extremely hazardous substances: No products were found.
CERCLA: Hazardous substances.: sodium hydroxide: 1000 lbs. (454 kg);

15. Regulatory information

SARA 313

None identified.

State regulations

- Massachusetts** : The following components are listed: SODIUM HYDROXIDE
Rhode Island : None of the components are listed.
New Jersey : The following components are listed: SODIUM HYDROXIDE; CAUSTIC SODA
Pennsylvania : The following components are listed: SODIUM HYDROXIDE (NA(OH))

California Prop. 65

None of the components are listed.

Canada

- WHMIS (Canada)** : Class D-1B: Material causing immediate and serious toxic effects (Toxic).
Class E: Corrosive material

- WHMIS (Pictograms)** :



Canadian lists

- Canadian NPRI** : None of the components are listed.
Canada inventory : All components are listed or exempted.

This product has been classified in accordance with the hazard criteria of the Controlled Products Regulations and the MSDS contains all the information required by the Controlled Products Regulations.

International regulations

- International lists** : **Australia inventory (AICS)**: All components are listed or exempted.
China inventory (IECSC): All components are listed or exempted.
Japan inventory: All components are listed or exempted.
Korea inventory: All components are listed or exempted.
New Zealand Inventory of Chemicals (NZIoC): All components are listed or exempted.
Philippines inventory (PICCS): All components are listed or exempted.
- Europe inventory** : All components are listed or exempted.

16. Other information

Hazardous Material Information System (U.S.A.) :

Health	*	3
Flammability		0
Physical hazards		1

Caution: HMIS® ratings are based on a 0-4 rating scale, with 0 representing minimal hazards or risks, and 4 representing significant hazards or risks. Although HMIS® ratings are not required on MSDSs under 29 CFR 1910.1200, the preparer may choose to provide them. HMIS® ratings are to be used with a fully implemented HMIS® program. HMIS® is a registered mark of the National Paint & Coatings Association (NPCA). HMIS® materials may be purchased exclusively from J. J. Keller (800) 327-6868.

The customer is responsible for determining the PPE code for this material.

- Date of issue** : 12/12/2011.
Date of previous issue : No previous validation.
Version : 1

☑ Indicates information that has changed from previously issued version.

Notice to reader

16. Other information

To the best of our knowledge, the information contained herein is accurate. However, neither the above-named supplier, nor any of its subsidiaries, assumes any liability whatsoever for the accuracy or completeness of the information contained herein.

Final determination of suitability of any material is the sole responsibility of the user. All materials may present unknown hazards and should be used with caution. Although certain hazards are described herein, we cannot guarantee that these are the only hazards that exist.

Material Safety Data Sheet

Section I			
Product Name	ZT-65		
Emergency Telephone No.	(616) 241 - 4684	Date Issued	3/27/2009
Manufacturer's Name and Address	Mitco, Inc. 1601 Steele S.W. Grand Rapids, MI 49507	Supersedes	10/27/2008
		Chemical Family	Aqueous Mixture
Hazardous Material Description, Shipping Name Hazard Class, Hazard ID No.(49 CFR 172.101)	Corrosive Liquid, Acidic, Organic, N.O.S., (Citric Acid Solution), 8, UN3265, III		

Section II – HAZARDOUS INGREDIENTS								
		Listed as Carcinogen or Potential Carcinogen						Reporting Required
Chemical Name	CAS Registry Number	National Toxicology Program	I.A.R.C. Mono- graph	OSHA	OSHA Permissible Exposure Limit	ACGIH Threshold Limit Value	Other Exposure Limit	Sec. 313 of Title III And 40CFR 372
Citric Acid	77-92-9	No	No	No	N/A	N/A	N/A	No

Section III – PHYSICAL DATA			
Boiling Point (°F)	212°F	Specific Gravity (H2O = 1)	1.2-1.3
Vapor Pressure (mm Hg)	17.5 @ 20°C	Percent, Volatile By Volume (%)	N/A
Vapor Density (AIR = 1)	1	Evaporation Rate (Water = 1)	1
Solubility in Water	Complete	pH	1.4
Appearance and Odor	Clear solution with no odor.		

Section IV – FIRE AND EXPLOSION HAZARD DATA				
Flash Point (°F)	>200	Flammable Limits	LEL	N/A
Method Used	N/A		UEL	N/A
Extinguishing Media	Carbon dioxide, dry chemical, foam or water spray.			
Special Fire Fighting Procedures	N/A			
Unusual Fire and Explosion Hazards	N/A			

Section V – HEALTH HAZARD DATA

Primary Routes of Entry	Inhalation	No	Skin Contact	Yes	Eyes	Yes
Effects of Overexposure	Acid solution. Corrosive to skin and eyes. Handle in accordance with good industrial hygiene and safety practices. These practices include avoiding unnecessary exposure and removal of the material from eyes, skin, and clothing.					
Emergency and First Aid Procedures	In case of contact with skin, wash at once with soap and water. For eyes, flush with water for at least 15 minutes and get medical attention. Wash contaminated clothing before reuse.					

Section VI – REACTIVITY DATA

Chemical Stability	Stable	Hazardous Polymerization	Will not occur
Conditions to Avoid	N/A		
Incompatibility (materials to avoid)	None known.		
Hazardous Decomposition Products	None Known		

Section VII – SPILL OR LEAK PROCEDURES

Steps to be taken in Case Material is Released or Spilled	Flush small spills to sanitary sewer with water. Contain large spills.
Waste Disposal Method	Neutralize solution carefully with alkaline material and flush to sanitary drain.

Section VIII – SPECIAL PROTECTION INFORMATION

Respiratory Protection	Not normally necessary.						
Ventilation	Not Necessary	Local Exhaust	N/A	Mechanical (General)	N/A	Special	N/A
Eye Protection	Chemical goggles						
Protective Gloves	Rubber						
Other Protective Clothing or Equipment	Rubber boots and apron if contact appears likely.						

Section IX – SPECIAL PRECAUTIONS

Precautions to be Taken in Handling and Storage	N/A
Other Precautions	N/A



Material Safety Data Sheet

SECTION 1: PRODUCT AND COMPANY IDENTIFICATION

Product Name: Heavy Brine

Synonyms: Mother Liquor, Centrate, Mixed Salt Solution

Manufacturer: Fairmont Brine Processing, LLC

Address: 168 AFR Drive
Fairmont, WV 26554

Emergency Phone: 304-363-9876

WHMIS Classification: Not Controlled

Chemical Family: H₂O, CaCl₂, NaCl, SrCl₂, MgCl₂, KCl

Product Use: De-icing, Dust Control, Drilling & Hydraulic-Fracturing

MSDS Revision Date: June 17th, 2014

Supersedes: December 6th, 2013

SECTION 2: COMPOSITION/INFORMATION ON INGREDIENTS

Composition:

Name	% by Weight	CAS #
Water	60 – 75%	7732-18-5
Calcium chloride	18-24%	10043-52-4
Sodium chloride	7-12%	7647-14-5
Strontium chloride	0-1%	10476-85-4
Magnesium chloride	0-1%	7786-30-3
Potassium chloride	0-1%	7447-40-7

SECTION 3: PHYSICAL STATE

Physical State: Liquid

Appearance/Odor: Colorless, Orange or Rust

Odor Threshold: Odorless

SECTION 4: HAZARDS IDENTIFICATION

Potential Acute Health Effects: Hazardous in case of skin contact (irritant), of eye contact (irritant), of ingestion, of inhalation. Slightly hazardous in case of skin contact (permeator).



Material Safety Data Sheet

Potential Chronic Health Effects:

CARCINOGENIC EFFECTS: Not available.
MUTAGENIC EFFECTS: Mutagenic for mammalian somatic cells. Mutagenic for bacteria and/or yeast.
TERATOGENIC EFFECTS: Not available.
DEVELOPMENTAL TOXICITY: Not available. The substance may be toxic to heart, cardiovascular system. Repeated or Prolonged exposure to the substance can produce target organs damage.

SECTION 4: FIRST AID MEASURES

Eye Contact:

Check for and remove any contact lenses. In case of contact, immediately flush eyes with plenty of water for at least 15 minutes. Cold water may be used. Get medical attention.

Skin Contact:

In case of contact, immediately flush skin with plenty of water. Cover the irritated skin with an emollient. Remove contaminated clothing and shoes. Cold water may be used. Wash clothing before reuse. Thoroughly clean shoes before reuse. Get medical attention.

Serious Skin Contact:

Wash with a disinfectant soap and cover the contaminated skin with an anti-bacterial cream. Seek immediate medical attention.

Inhalation:

If inhaled, remove to fresh air. If not breathing, give artificial respiration. If breathing is difficult, give oxygen. Get medical attention.

Ingestion:

Do NOT induce vomiting unless directed to do so by medical personnel. Never give anything by mouth to an unconscious person. If large quantities of this material are swallowed, call a physician immediately. Loosen tight clothing such as a collar, tie, belt or waistband.

SECTION 5: FIRE AND EXPLOSION DATA

Flammability of the Product:

Non-flammable.

Auto-Ignition Temperature:

Non-applicable.

Flash Points:

Not applicable.

Flammable Limits:

Not applicable.

Products of Combustion:

Not available.

Fire Hazards in Presence of Various Substances:

Not applicable.

Explosion Hazards in Presence of Various Substances:

Risks of explosion of the product in presence of mechanical impact: Not available. Risks of explosion of the product in presence of static discharge: Not available.



Material Safety Data Sheet

Fire Fighting Meida and Instructions:

Not applicable.

Special Remarks on Fire Hazards:

Not available.

Special Remarks on Explosion Hazards:

Furan-2-peroxycarboxylic acid + calcium chloride causes explosion at room temperature.

SECTION 6: ACCIDENTAL RELEASE MEASURES

Small and/or Large Spill:

Contain spilled material if possible. Absorb with materials such as sand. Use appropriate tools to put the spilled liquid in a suitable and properly labled disposal container. Finish cleaning by spreading water on the contaminated surface and dispose of according to local and regional authority requirements.

SECTION 7: HANDLING AND STORAGE

Storage Conditions:

Keep container tightly closed. Protect from atmospheric moisture.

Handling Procedures:

Avoid contact with skin, eyes and clothing. Wash thoroughly after handling.

SECTION 8: EXPOSURE CONTROLS/PERSONAL PROTECTION

Regulatory Exposure Limit(s):

Component	OSHA Final PEL TWA	OSHA Final PEL STEL	OSHA Final PEL Ceiling
Particles not otherwise regulated	TWA 15 mg/m3 (total) TWA 5 mg/m3 (respirable)	-----	-----

Non-Regulatory Exposure Limit(s):

Component	CAS #	ACGIH TWA	ACGIH STEL	ACGIH Ceiling	OSHA TWA (vacated)	OSHA STEL (vacated)	OSHA Ceiling (vacated)
Particles Not Otherwise Specified (PNOS)	-----	TWA 10 mg/m3 (inhalable) TWA 3 mg/m3 (respirable)	-----	-----	-----	-----	-----

OEL:

Occupational Exposure Limit

OSHA:

United States Occupational Safety and Health Administration

PEL:

Permissible Exposure Limit

TWA:

Time Weighted Average

STEL:

Short Term Exposure Limit



Material Safety Data Sheet

The Non-Regulatory United States Occupational Safety and Health Administration (OSHA) limits shown in the table are the Vacated 1989 PEL's (vacated by 58 FR 35338, June 30, 1993).

- The American Conference of Governmental Industrial Hygienists (ACGIH) is a voluntary organization of professional industrial hygiene personnel in government or educational institutions in the United States. The ACGIH develops and publishes recommended occupational exposure limits each year called Threshold Limit Values (TLVs) for hundreds of chemicals, physical agents, and biological exposure indices.

Engineering Controls:

Use local exhaust ventilation, or other engineering controls to maintain airborne levels below exposure limit requirements or guidelines. If there are no applicable exposure limit requirements or guidelines, general ventilation should be sufficient for most operations. Local exhaust ventilation may be necessary for some operations.

PERSONAL PROTECTIVE EQUIPMENT:

Eye Protection:

Wear chemical safety goggles.

Skin and Body Protection:

Use protective clothing chemically resistant to this material. Selection of specific items such as face shield, boots, apron, or full body suit will depend on the task. Remove contaminated clothing immediately, wash skin area with soap and water, and launder clothing before reuse or dispose of properly.

Hand Protection:

Use gloves chemically resistant to this material. If hands are cut or scratched, use gloves chemically resistant to this material even for brief exposures. Examples of preferred glove barrier materials include: Neoprene, Polyvinyl chloride ("PVC" or "vinyl"), Nitrile/butadiene rubber ("nitrile" or "NBR"). NOTICE: The selection of a specific glove for a particular application and duration of use in a workplace should also take into account all relevant workplace factors such as, but not limited to: Other chemicals which may be handled, physical requirements (cut/puncture protection, dexterity, thermal protection), potential body reactions to glove materials, as well as the instructions/specifications provided by the glove supplier. Avoid gloves made of Polyvinyl alcohol (PVA).

Respiratory Protection:

Respiratory protection should be worn when there is a potential to exceed the exposure limit requirements or guidelines. If there are no applicable exposure limit requirements or guidelines, wear respiratory protection when adverse effects, such as respiratory irritation or discomfort have been experienced, or where indicated by your risk assessment process. In dusty or misty atmospheres, use an approved particulate respirator. The following should be effective types of air-purifying respirators: High efficiency particulate air (HEPA) N95. A respiratory protection program that meets 29 CFR 1910.134 must be followed whenever workplace conditions warrant use of a respirator.

SECTION 9: PHYSICAL AND CHEMICAL PROPERTIES

Physical state and appearance:	Liquid.
Color:	Colorless to orange or rust.
Odor:	Odorless.
Boiling Point/Range:	108 C (226 F) Literature.
Freezing Point/Range:	-15 F to -35 F
Melting Point/Range:	Not applicable.
Decomposition Temperature:	Not applicable.
Vapor Pressure:	16 mmHg@ 25 C Literature.
Vapor Density (air=1):	Not applicable.
Specific Gravity (water=1):	1.219 - 1.263 Literature.
Water Solubility:	Completely miscible.
pH:	5-7.5
Flash point:	Not applicable.
Lower Flammability Level (air):	Not applicable.
Upper Flammability Level (air):	Not applicable.
Autoignition Temperature:	Not applicable.
Viscosity:	2.6 cSt @ 25 C Typical

SECTION 10: STABILITY AND REACTIVITY DATA

Stability:	This product is stable.
Conditions to Avoid:	None known.
Incompatibility with various substances:	Avoid contact with: Sulfuric acid. Flammable hydrogen may be generated from contact with metals such as: Zinc and Sodium. Reaction of bromide impurity with oxidizing materials may generate trace levels of impurities such as bromate.
Corrosivity:	Corrosive to some metals. Avoid contact with metals such as brass, ferrous metals, and mild steel.



Material Safety Data Sheet

Hazardous Decomposition Products:

Does not decompose.

Hazardous Polymerization:

Will not occur.

SECTION 11: TOXICOLOGICAL INFORMATION

Routes of Entry:

Absorbed through skin. Inhalation. Ingestion.

Toxicity to Animals:

Acute oral toxicity (LD50): 918 - 1,668 mg/kg (Rat).

Chronic Effects on Humans:

MUTAGENIC EFFECTS: Mutagenic for mammalian somatic cells. Mutagenic for bacteria and/or yeast. May cause damage to the following organs: heart, cardiovascular system.

Other Toxic Effects on Humans:

Hazardous in case of skin contact (irritant), of ingestion, of inhalation. Slightly hazardous in case of skin contact (permeator).

Special Remarks on Toxicity to Animals:

Lowest Published Lethal Dose: LDL (Rabbit) – Route: Oral; Dose: >5,000 mg/kg

Carcinogenicity:

This product is not classified as a carcinogen by NTP, IARC or OSHA.

SECTION 12: ECOLOGICAL INFORMATION

Fate and Transport:

Material is practically non-toxic to aquatic organisms on an acute basis.

Biodegradation:

Not applicable.

Bioconcentration:

No bioconcentration is expected due to relatively high water solubility. Potential for mobility in soil is very high (Koc between 0 and 50). Partitioning from water to n-octanol is not applicable.

SECTION 13: DISPOSAL CONSIDERATIONS

Disposal:

Reuse or recycle if possible. All disposal practices must be in compliance with all Federal, State/Provincial and local laws and regulations. Regulations may vary in different locations. AS YOUR SUPPLIER, WE HAVE NO CONTROL OVER THE MANAGEMENT PRACTICES OR MANUFACTURING PROCESSES OF PARTIES HANDLING OR USING THIS MATERIAL. THE INFORMATION PRESENTED HERE PERTAINS ONLY TO THE PRODUCT AS SHIPPED IN ITS INTENDED CONDITION AS DESCRIBED IN MSDS SECTION: Composition Information. FOR UNUSED & UNCONTAMINATED PRODUCT, the preferred options include sending to a licensed, permitted: Reclaimer or Waste Water Treatment System.



Material Safety Data Sheet

SECTION 14: TRANSPORT INFORMATION

U.S. Department of Transportation:	As applicable to user's operations and state or country regulations.
Department of Environmental Protection:	As applicable to user's operations and state or country regulations.
Environmental Protection Agency:	As applicable to user's operations and state or country regulations.
State and or County Regulations:	As applicable to user's operations and state or country regulations.

SECTION 15: REGULATORY INFORMATION

OSHA REGULATORY STATUS:	This material is considered hazardous by the OSHA Hazard Communication Standard (29 CFR 1910.1200). CERCLA SECTIONS 102a/103 HAZARDOUS SUBSTANCES (40 CFR 302.4): Not regulated. EPCRA EXTREMELY HAZARDOUS SUBSTANCES (40 CFR 355.30): Not regulated. EPCRA SECTIONS 311/312 HAZARD CATEGORIES (40 CFR 370.10): Acute Health Hazard EPCRA SECTION 313 (40 CFR 372.65): To the best of our knowledge, this product does not contain chemicals at levels which require reporting under this statute. OSHA PROCESS SAFETY (PSM) (29 CFR 1910.119): Not regulated.
--------------------------------	---------------------------------------------------------------------------------------------------------------------------------------------------------------------------------------------------------------------------------------------------------------------------------------------------------------------------------------------------------------------------------------------------------------------------------------------------------------------------------------------------------------------------------------------------------------------------------------------------

SECTION 16: OTHER INFORMATION

References:	Not available.
Other Special Considerations:	Not available.

The information above is believed to be accurate and represents the best information currently available to us. However, we make no warranty of merchantability or any other warranty, express or implied, with respect to such information, and we assume no liability resulting from its use. Users should make their own investigations to determine the suitability of the information for their particular purposes. In no event shall Fairmont Brine Processing, LLC be liable for any claims, losses, or damages of any third party or for lost profits or any special, indirect, incidental, consequential or exemplary damages, howsoever arising, even if Fairmont Brine Processing, LLC has been advised of the possibility of such damages. This information is not intended to be all-inclusive as to the manner and conditions of use, handling, storage, disposal and other factors that may involve other or additional legal, environmental, safety or performance considerations, and Fairmont Brine Processing, LLC assumes no liability whatsoever for the use of or reliance upon this information. While our technical personnel will be happy to respond to questions, safe handling and use of the product remains the responsibility of the customer. No suggestions for use are intended as, and nothing herein shall be construed as, a recommendation to infringe any existing patents or to violate any Federal, State, local or foreign laws. OSHA Standard 29 CFR 1910.1200 requires that information be provided to employees regarding the hazards of chemicals by means of a hazard communication program including labeling, safety data sheets, training and access to written records. Fairmont Brine Processing, LLC requests that you, and it is your legal duty to, make all information in this Material Safety Data Sheet available to your employees.

MATERIAL SAFETY DATA SHEET

Process Salt

FILE NO.: 2.0
MSDS DATE: 1/1/2014

SECTION 1: PRODUCT AND COMPANY IDENTIFICATION

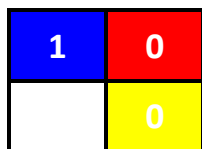

PRODUCT NAME: Process Salt
SYNONYMS: Salt, Road Salt, Rock Salt
MANUFACTURER: Fairmont Brine Processing
ADDRESS: 168 AFR Drive
Fairmont, WV 26554
EMERGENCY PHONE: 304-363-9876
WHMIS Classification: Not Controlled
CHEMICAL FAMILY: Inorganic Salt
PRODUCT USE: De-icing

SECTION 2: COMPOSITION/INFORMATION ON INGREDIENTS

<u>Components:</u>	<u>CAS NO.</u>	<u>% WT</u>
Sodium Chloride	7647-14-5	94.0% to 98%

SECTION 3: PHYSICAL DATA

Physical State:	Solid
Appearance/Odor	White to off-white crystals / odorless
Odor Threshold:	N/A
Specific Gravity:	2.165 g/cm ³
pH:	N/A
Vapor Pressure:	2.4
Solubility in Water:	317 g/L
% Volatile:	N/A
Vapor Density:	N/A

SECTION 4: FIRE AND EXPLOSION HAZARD

Flammability:	No
If yes, under what conditions:	N/A
Means of Extinguishing:	N/A
Special Procedure:	None. Product can be used to extinguish fire.
Flash Point:	N/A
Upper Explosion Limit:	N/A
Lower Explosion Limit:	N/A
Auto Ignition Temperature:	N/A
Sensitfivty to Mechanical Impact:	N/A
Sensitivity to Static Discharge:	N/A

SECTION 5: REACTIVITY DATA

Chemical Stability:	Yes
If no, under what condition:	N/A
Incompatibility With Other Substances:	Yes
If so, which ones:	Corrosive to some metals such as brass, mild steel, aluminum or ferrous metals.
Reativity Under What Conditions:	N/A
Hazardous Decomposition Products:	Chlorine fumes are given off at temperatures >1600°C

MATERIAL SAFETY DATA SHEET

Process Salt

FILE NO.: 2.0
MSDS DATE: 1/1/2014

SECTION 6: HEALTH HAZARDS

Route of Entry:	Skin contact and ingestion
Effect of Acute Exposure to Material:	Moderately toxic LD50 (oral rate): 1000 mg/Kg
Effect of Chronic Exposure to Material:	Unknown
Exposure Limit:	TW AEV for nuisance particulates 10 mg/m ³
Synergetic Material:	None
Irritancy of Material:	Minor irritant
Sensitivity of Material:	Does not occur
Carcinogenic, Reproductive Effects:	None

SECTION 7: FIRST AID MEASURES

Eye Contact:	In case of contact, immediately flush eyes with plenty of water for at least 15 minutes. Cold water may be used. Seek medical attention immediately.
Skin Contact:	Remove from skin by wiping and washing thoroughly with water.
Inhalation:	Remove victim to fresh air.
Ingestion:	If discomfort exists, induce vomiting. Seek medical attention immediately.

SECTION 8: PREVENTATIVE MEASURES

Eye Contact:	Wear safety goggles.
Skin Contact:	Wear rubber gloves, boots and long sleeve shirts.
Inhalation:	For dusty or misty conditions, wear NIOSH approved dust or mist respirator.
Engineering Controls:	Mechanical ventilation recommended in enclosed areas.
Waste Disposal:	Dispose of material in government approved landfill site in accordance with local laws.
Handling Procedures and Equipment:	Wash skin and equipment with water.
Storage Requirements:	Store in cool dry area.
Special Shipping Information:	No special shipping procedures.

SECTION 9: PREPARATION INFORMATION

Prepared By:	Fairmont Brine Processing, LLC
Telephone:	304-363-9876
Preparation Date:	January, 2014
Superseded Date:	All Previous Versions



ATTACHMENT E

SUPPORTING CALCULATIONS



TOTAL EMISSIONS SUMMARY:

E-1: Natural Gas Fired Boiler				
Pollutant	Current Permit Emission Limits		Calculated PTE	
	lb/hour	tons/year	lb/hour	tons/year
CO	3.20	14.02	1.40	6.13
NO _x	3.7	16.21	1.10	4.80
PM	0.30	1.31	0.18	0.79
SO ₂	0.02	0.10	0.02	0.09
VOC	0.21	0.91	0.11	0.50

Proposed modifications have no identified impact on Emissions E-1.

E-2: Natural Gas Fueled Rotary Dryer				
Pollutant	Current Permit Emission Limits		Calculated PTE	
	lb/hour	tons/year	lb/hour	tons/year
CO	0.34	1.48	0.34	1.48
NO _x	0.40	1.76	0.40	1.76
PM	0.03	0.13	0.03	0.13
SO ₂	Not provided	Not provided	0.002	0.01
VOC	0.02	0.10	0.02	0.10

Proposed modifications have no identified impact on Emissions E-2.



TOTAL EMISSIONS SUMMARY (CONTINUED):

E-3: Evaporator				
Pollutant	Current Permit Emission Limits		Calculated PTE <u>with Air Pollution Control Device</u>	
	lb/hour	tons/year	lb/hour	tons/year
VOC	Not provided	Not provided	0.16	0.70
HAP	Not provided	Not provided	0.05	0.23
TAP	Not provided	Not provided	0.03	0.12
Pb	Not provided	Not provided	0.004	0.02
Pollutant	lb/hour	tons/year	lb/hour	tons/year
VOC/HAP	0.15	Not provided	0.18	0.81
Maximum Process Rate of Raw Brine	8,760 gallons per hour		9,450 gallons per hour	

Proposed emissions are greater than the current permit emission limits. FBP plans to replace the existing third effect heat exchanger, 02-HX-003, which will allow for an increase in plant capacity. This change will increase Emissions E-3. Additionally, previous emissions calculations were based on very limited water analyses. These calculations are based on analytical results for ten (10) recent samples pulled from two (2) sample locations. Parameters required under NPDES Permit WV0116408 were analyzed.

E-4: Oil Storage Tank				
Pollutant	Current Permit Emission Limits		Calculated PTE	
	lb/hour	tons/year	lb/hour	tons/year
VOC	Not provided	Not provided	0.06	0.27
Pollutant	lb/year		lb/year	
VOC	546		546	

Proposed modifications have no identified impact on Emissions E-4.



TOTAL EMISSIONS SUMMARY (CONTINUED):

E-6: Lime Silo				
Pollutant	Current Permit Emission Limits		Calculated PTE	
	lb/hour	tons/year	lb/hour	tons/year
PM	NA	NA	0.07	0.02

FBP plans to expand their pretreatment operations to include chemical precipitation, clarification, and effluent and sludge processing. This includes the installation of a lime silo, 01-TK-015 (new Emissions E-6).

E-7: Natural Gas Fired Boiler				
Pollutant	Current Permit Emission Limits		Calculated PTE	
	lb/hour	tons/year	lb/hour	tons/year
CO	NA	NA	1.24	5.43
NO _x	NA	NA	2.31	10.14
PM	NA	NA	0.19	0.81
SO ₂	NA	NA	0.02	0.09
VOC	NA	NA	0.12	0.52

FBP plans to install a second natural gas fueled boiler, 03-B-002 (new Emissions E-7) to provide a redundant heat source for the evaporation process.



DETAILED CALCULATIONS:

Emissions Point E-1: Natural Gas Fired Boiler

Boiler Specification	
Manufacturer	Hurst Boiler and Welding Company Inc.
Model No.	Scotch S400-G-900-300
Serial No.	S4500-300-5
Boiler output (MBH)	30,128
Horsepower	900
Maximum design steaming capacity (lb/hour)	31,050
Annual operating hours	8,760
Burner Specification	
Manufacturer	Power Flame Incorporated
Model No.	LNICM11-G-30 (Low NO _x burner)
Serial No.	030933075
Gas high fire rate (MBH)	37,800

Reference: Attachment E-1 – Power Flame Incorporated Typical Flue Product Emissions Data for Power Flame Burners

Emissions Point E-1: Natural Gas Fired Boiler PTE

Pollutant	lb per 10⁶ btu Input	lb/hour	tons/year
CO	0.037	1.40	6.13
NO _x	0.029	1.10	4.80
PM	0.0048	0.18	0.79
SO ₂	0.000525	0.02	0.09
VOC	0.003	0.11	0.50



DETAILED CALCULATIONS (CONTINUED):

Example calculation for CO emissions,

$$0.037 \text{ lb} / 10^6 \text{ btu} \times 37,800,000 \text{ btu/hour} = 1.40 \text{ lb/hour}$$

$$1.40 \text{ lb/hour} \times 8,760 \text{ hours/year} / 2,000 \text{ lb/ton} = 6.13 \text{ tons/year}$$

Emissions Point E-2: Natural Gas Fueled Rotary Dryer

Manufacturer	Louisville Dryer Company
Model No.	Co-current Direct Fired Dryer 60" diameter x 20' long
Serial No.	CD1095
Heat Requirement (MBH)	3,200
Natural gas heating value (btu/ft ³)	1,000
Fuel usage (ft ³ /hour)	4,020
Annual operating hours	8,760

Reference: Attachment E-2 – AP-42, Compilation of Air Pollutant Emission Factors, Section 1.4 Natural Gas Combustion, Tables 1.4-1. and 1.4-2

Emissions Point E-2: Natural Gas Fueled Rotary Dryer PTE

Pollutant	AP-42 Emission Factor (lb/10 ⁶ ft ³)	lb/hour	tons/year
CO	84	0.34	1.48
NO _x	100	0.40	1.76
PM	7.6	0.03	0.13
SO ₂	0.6	0.002	0.01
VOC	5.5	0.02	0.10

Example calculation for CO emissions,

$$84 \text{ lb} / 10^6 \text{ ft}^3 \times 4,020 \text{ ft}^3/\text{hour} = 0.34 \text{ lb/hour}$$

$$0.34 \text{ lb/hour} \times 8,760 \text{ hours/year} / 2,000 \text{ lb/ton} = 1.48 \text{ tons/year}$$



DETAILED CALCULATIONS (CONTINUED):

Emissions Point E-3: Evaporator

In order to calculate VOC/HAP/TAP emissions, the analytical results for ten (10) recent samples pulled from two (2) sample locations were reviewed. Outlet 201 samples represent untreated brine sampled from incoming trucks at the loading bays. Outlet 101 samples represent pretreated brine sampled after the carbon vessels prior to the brine impoundment. The parameters required under NPDES Permit WV0116408 were analyzed. The maximum values for VOC/HAP/TAP components from these analyses are listed in the following table:

Pollutant	No. of Samples	Sample Loc. (Outlet)	mg/l
Arsenic	10	101	0.102
Benzene	10	201	0.559
Bis(2-ethylhexyl)phthalate	10	101	0.0068
Cadmium	10	101	0.0141
Chromium	10	101	0.027
Cobalt	10	101	0.052
Decane	10	101	2.13*
Dimethyl phthalate	10	201	0.0087
Lead	10	101	0.0767
Nickel	10	101	0.201
Nitrated Hydrocarbons, Total	10	201	0.0254
Octadecane	10	101	0.65
Selenium	10	101	0.054
Pollutant	No. of Samples	Sample Loc. (Outlet)	pCi/l
Gross Alpha	10	201	14,920
Gross Beta	10	201	2,440
Radium-226	10	201	8,813
Radium-228	10	201	1,483

* One data point was removed from the data set based the value being more than 1.5 interquartile ranges above the third quartile (outlier by definition).



ATTACHMENT E – SUPPORTING CALCULATIONS

DETAILED CALCULATIONS (CONTINUED):

VOC/HAP/TAP concentrations were factored by 3 to account for potential variability.

Water Process Rate = 5,400 barrels/day = 35,772 liters/hour

Emissions Point E-3: Evaporator PTE

Pollutant	VOC/HAP/TAP	mg/l	lb/hour	tons/year
Arsenic	HAP	0.306	0.024	0.11
Benzene	VOC/HAP/TAP	1.677	0.132	0.58
Bis(2-ethylhexyl)phthalate	SVOC/HAP	0.020	0.002	0.01
Cadmium	HAP	0.042	0.003	0.01
Chromium	HAP	0.081	0.006	0.03
Cobalt	HAP	0.156	0.012	0.05
Decane	SVOC	6.39	0.503	2.20
Dimethyl phthalate	SVOC	0.026	0.002	0.01
Lead	HAP	0.230	0.018	0.08
Nickel	HAP	0.603	0.047	0.21
Nitrated Hydrocarbons, Total	SVOC	0.076	0.006	0.03
Octadecane	SVOC	1.95	0.153	0.67
Selenium	HAP	0.162	0.013	0.06
VOC			0.80	3.50
HAP			0.26	1.13
TAP			0.13	0.58
Pb			0.02	0.08
TOTAL VOC/HAP			0.92	4.04

Example calculation for Arsenic emissions,

$$(0.306 \text{ mg/l} \times 35,772 \text{ liters/hour}) / (10^6 \text{ mg/kg}) \times 2.2 \text{ lb/kg} = 0.024 \text{ lb/hour}$$

$$0.024 \text{ lb/hour} \times 8,760 \text{ hours/year} / 2,000 \text{ lb/ton} = 0.11 \text{ tons/year}$$



DETAILED CALCULATIONS (CONTINUED):

The air pollution control device was manufactured by TIGG Corporation. The device is an N 1800PDB vessel filled with 1,700 lbs. of TIGG 5CC coconut based carbon. A minimum efficiency of 80% was used to determine the controlled air emissions.

Emissions Point E-3: Evaporator PTE with Air Pollution Control Device

Pollutant	lb/hour	tons/year
VOC	0.16	0.70
HAP	0.05	0.23
TAP	0.03	0.12
Pb	0.004	0.02
TOTAL VOC/HAP	0.18	0.81



DETAILED CALCULATIONS (CONTINUED):

Emissions Point E-4: Oil Storage Tank

TANKS 4.0.9d	
Emissions Report - Detail Format	
Tank Identification and Physical Characteristics	
Identification	
User Identification:	01-TK-009 Fixed Roof
City:	Fairmont
State:	West Virginia
Company:	Fairmont Brine Processing
Type of Tank:	Vertical Fixed Roof Tank
Description:	Oil Storage Tank
Tank Dimensions	
Shell Height (ft):	25.50
Diameter (ft):	10.00
Liquid Height (ft) :	25.00
Avg. Liquid Height (ft):	12.50
Volume (gallons):	15,000.00
Turnovers:	6.00
Net Throughput(gal/yr):	90,000.00
Is Tank Heated (y/n):	N
Paint Characteristics	
Shell Color/Shade:	White/White
Shell Condition:	Good
Roof Color/Shade:	White/White
Roof Condition:	Good
Roof Characteristics	
Type:	Dome
Height (ft)	26.00
Radius (ft) (Dome Roof)	10.00
Breather Vent Settings	
Vacuum Settings (psig):	-0.03
Pressure Settings (psig)	0.03
Meteorological Data used in Emissions Calculations: Pittsburgh, Pennsylvania (Avg Atmospheric Pressure = 14.11 psia)	

TANKS 4.0.9d													
Emissions Report - Detail Format													
Liquid Contents of Storage Tank													
01-TK-009 Fixed Roof - Vertical Fixed Roof Tank													
Fairmont, West Virginia													
Mixture/Component	Months	Daily Liquid Surf Temperature (deg F)			Liquid Bulk Temp (deg F)	Vapor Pressure (psi a)			Vapor Mol. Weight	Liquid Mass Fract.	Vapor Mass Fract.	Mol. Weight	Basis for Vapor Pressure Calculations
Crude oil (RVP 5)	All	Avg.	Min.	Max.	50.33	Avg.	Min.	Max.	50.0000			207.00	Option 4: RVP=5
		51.94	47.05	56.81		2.4501	2.2174	2.7022					



DETAILED CALCULATIONS (CONTINUED):

Emissions Point E-4: Oil Storage Tank

TANKS 4.0.9d
Emissions Report - Detail Format
Detail Calculations (AP-42)

01-TK-009 Fixed Roof - Vertical Fixed Roof Tank
Fairmont, West Virginia

Annual Emission Calculations

Standing Losses (lb):	348.6377
Vapor Space Volume (cu ft):	11,244.8073
Vapor Density (lb/cu ft):	0.0223
Vapor Space Expansion Factor:	0.0746
Vented Vapor Saturation Factor:	0.0510
Tank Vapor Space Volume:	
Vapor Space Volume (cu ft):	11,244.8073
Tank Diameter (ft):	10.0000
Vapor Space Outage (ft):	143.1733
Tank Shell Height (ft):	25.5000
Average Liquid Height (ft):	12.5000
Roof Outage (ft):	130.1733
Roof Outage (Dome Roof)	
Roof Outage (ft):	130.1733
Dome Radius (ft):	10.0000
Shell Radius (ft):	5.0000
Vapor Density	
Vapor Density (lb/cu ft):	0.0223
Vapor Molecular Weight (lb/lb-mole):	90.0000
Vapor Pressure at Daily Average Liquid Surface Temperature (psia):	2.4501
Daily Avg. Liquid Surface Temp. (deg. R):	511.8051
Daily Average Ambient Temp. (deg. F):	50.3063
Ideal Gas Constant R (psia cu ft / (lb-mol-deg R)):	10.731
Liquid Bulk Temperature (deg. R):	505.9963
Tank Paint Solar Absorptance (Shell):	0.1700
Tank Paint Solar Absorptance (Roof):	0.1700
Daily Total Solar Insulation Factor (Btu/sqft day):	1,202.9656
Vapor Space Expansion Factor	
Vapor Space Expansion Factor:	0.0746
Daily Vapor Temperature Range (deg. R):	19.5141
Daily Vapor Pressure Range (psia):	0.4848
Breather Vent Press. Setting Range (psia):	0.0600
Vapor Pressure at Daily Average Liquid Surface Temperature (psia):	2.4501
Vapor Pressure at Daily Minimum Liquid Surface Temperature (psia):	2.2174
Vapor Pressure at Daily Maximum Liquid Surface Temperature (psia):	2.7022
Daily Avg. Liquid Surface Temp. (deg R):	511.8051
Daily Min. Liquid Surface Temp. (deg R):	505.7266
Daily Max. Liquid Surface Temp. (deg R):	516.4836
Daily Ambient Temp. Range (deg. R):	19.1500
Vented Vapor Saturation Factor	
Vented Vapor Saturation Factor:	0.0510
Vapor Pressure at Daily Average Liquid Surface Temperature (psia):	2.4501
Vapor Space Outage (ft):	143.1733
Working Losses (lb):	186.8833
Vapor Molecular Weight (lb/lb-mole):	90.0000
Vapor Pressure at Daily Average Liquid Surface Temperature (psia):	2.4501
Annual Net Throughput (gal/yr.):	90,000.0000
Annual Turnovers:	6.0000
Turnover Factor:	1.0000
Maximum Liquid Volume (gall):	15,000.0000
Maximum Liquid Height (ft):	25.0000
Tank Diameter (ft):	10.0000
Working Loss Product Factor:	0.7500
Total Losses (lb):	545.5209



DETAILED CALCULATIONS (CONTINUED):

Emissions Point E-4: Oil Storage Tank

TANKS 4.0.9d
Emissions Report - Detail Format
Individual Tank Emission Totals

Emissions Report for: Annual

01-TK-009 Fixed Roof - Vertical Fixed Roof Tank
Fairmont, West Virginia

Components	Losses(lbs)		
	Working Loss	Breathing Loss	Total Emissions
Crude oil (RVP 5)	196.88	348.64	545.52

Emissions Point E-6: Limo Silo

Lime Silo, 01-TK-015, will be equipped with a roof-mounted dust collector (01-F-015). When hydrated lime is pneumatically conveyed into 01-TK-015, the excess air will be vented through 01-F-015.

Dust Collector Specification	
Manufacturer	Bulk Conveyor Specialist, Inc.
Model No.	BV96-25 Bin Vent
Cloth Area	235 ft ²
Filter Fabric	16 oz. polyester felt, 4 ½” diameter x 8’ length
PM Emission (assumed)	0.01 gr/dscf (Assumes an inlet dust loading of 10 gr/dscf and 99.9% filtering efficiency.)



DETAILED CALCULATIONS (CONTINUED):

Estimated Lime Silo Operating Data	
Hydrated lime usage (lb/hr)	1,800
Annual operating hours	8,760
Annual usage (lb/year)	15,768,000
Lime added (lb/fill event)	44,000
Filling frequency (fill/year)	358
Filling duration (hours)	1.5 (based on an unloading rate of 500 lb/min)
Air flow rate (cfm)	700
Lime density (lb/ft ³)	25
Lime volume added (ft ³ /fill)	1,760
Safety factor (%)	20

Air volume through filter = 700 ft³/min x 60 min/hr x 1.5 hr/event + 1,760 ft³/event

Air volume through filter = 64,760 ft³/event

Emissions Point E-6: Limo Silo PTE

Maximum estimated hourly PM emissions =

$$64,760 \text{ ft}^3/\text{event} \times 0.01 \text{ gr/dscf} \times 1 \text{ lb}/7000 \text{ gr} \times 1 \text{ event}/1.5 \text{ hr} \times 1.20 = 0.07 \text{ lb/hr}$$

Maximum estimated annual PM emissions =

$$0.074 \text{ lb/hr} \times 1.5 \text{ hr/event} \times 358 \text{ event/yr} \times 1 \text{ ton}/2000 \text{ lb} = 0.02 \text{ tons/yr}$$



DETAILED CALCULATIONS (CONTINUED):

Emissions Point E-7: Natural Gas Fired Boiler

Boiler Specification	
Manufacturer	Cleaver-Brooks
Model No.	CB 800-300# Stm.
Serial No.	78837
Boiler output (MBH)	26,780
Horsepower	800
Maximum design steaming capacity (lb/hour)	27,600
Annual operating hours	8,760
Gas 100% firing rate (MBH)	33,057

Reference: Attachment E-7 – Cleaver-Brooks Boiler Expected Emission Data

Emissions Point E-7: Natural Gas Fired Boiler PTE

Pollutant	lb per 10⁶ btu Input	lb/hour	tons/year
CO	0.0375	1.24	5.43
NO _x	0.0700	2.31	10.14
PM	0.0056	0.19	0.81
SO ₂	0.0006	0.02	0.09
VOC	0.0036	0.12	0.52

Example calculation for CO emissions,

$$0.0375 \text{ lb} / 10^6 \text{ btu} \times 33,057,000 \text{ btu/hour} = 1.24 \text{ lb/hour}$$

$$1.24 \text{ lb/hour} \times 8,760 \text{ hours/year} / 2,000 \text{ lb/ton} = 5.43 \text{ tons/year}$$



ATTACHMENT E-1

Power Flame Incorporated Typical Flue Product Emissions Data
for Power Flame Burners

Power Flame Incorporated



Typical Flue Product Emissions Data for Power Flame Burners

Natural Gas

Carbon Monoxide - CO	.037 lb CO 10 ⁶ BTU input (50 PPM)
Sulfur Dioxide - SO ₂	(1.05) x (% Sulfur by weight in fuel) = lb SO ₂ per 10 ⁶ BTU Input
Particulate Matter	.0048 lb PM per 10 ⁶ BTU input
Hydrocarbons	.025 lb HC's per 10 ⁶ BTU input
CO ₂	9 % to 10%
Nitrogen Oxides - NO_x	
Standard Burner	.088 lb NO _x per 10 ⁶ BTU input (75 PPM)
Low NOx Burner	.029 lb NO _x per 10 ⁶ BTU input (25) PPM

Burning natural gas the VOC are estimated at 0.003 # per million BTU and SO_x are 0.0005 # per million

In instances where guarantees are required, please consult the factory with the specific application information.



ATTACHMENT E-2

AP-42, Compilation of Air Pollutant Emission Factors,
Section 1.4 Natural Gas Combustion, Tables 1.4-1. and 1.4-2.

Table 1.4-1. EMISSION FACTORS FOR NITROGEN OXIDES (NO_x) AND CARBON MONOXIDE (CO) FROM NATURAL GAS COMBUSTION^a

Combustor Type (MMBtu/hr Heat Input) [SCC]	NO _x ^b		CO	
	Emission Factor (lb/10 ⁶ scf)	Emission Factor Rating	Emission Factor (lb/10 ⁶ scf)	Emission Factor Rating
Large Wall-Fired Boilers (>100) [1-01-006-01, 1-02-006-01, 1-03-006-01]				
Uncontrolled (Pre-NSPS) ^c	280	A	84	B
Uncontrolled (Post-NSPS) ^c	190	A	84	B
Controlled - Low NO _x burners	140	A	84	B
Controlled - Flue gas recirculation	100	D	84	B
Small Boilers (<100) [1-01-006-02, 1-02-006-02, 1-03-006-02, 1-03-006-03]				
Uncontrolled	100	B	84	B
Controlled - Low NO _x burners	50	D	84	B
Controlled - Low NO _x burners/Flue gas recirculation	32	C	84	B
Tangential-Fired Boilers (All Sizes) [1-01-006-04]				
Uncontrolled	170	A	24	C
Controlled - Flue gas recirculation	76	D	98	D
Residential Furnaces (<0.3) [No SCC]				
Uncontrolled	94	B	40	B

^a Reference 11. Units are in pounds of pollutant per million standard cubic feet of natural gas fired. To convert from lb/10⁶ scf to kg/10⁶ m³, multiply by 16. Emission factors are based on an average natural gas higher heating value of 1,020 Btu/scf. To convert from lb/10⁶ scf to lb/MMBtu, divide by 1,020. The emission factors in this table may be converted to other natural gas heating values by multiplying the given emission factor by the ratio of the specified heating value to this average heating value. SCC = Source Classification Code. ND = no data. NA = not applicable.

^b Expressed as NO₂. For large and small wall fired boilers with SNCR control, apply a 24 percent reduction to the appropriate NO_x emission factor. For tangential-fired boilers with SNCR control, apply a 13 percent reduction to the appropriate NO_x emission factor.

^c NSPS=New Source Performance Standard as defined in 40 CFR 60 Subparts D and Db. Post-NSPS units are boilers with greater than 250 MMBtu/hr of heat input that commenced construction modification, or reconstruction after August 17, 1971, and units with heat input capacities between 100 and 250 MMBtu/hr that commenced construction modification, or reconstruction after June 19, 1984.

TABLE 1.4-2. EMISSION FACTORS FOR CRITERIA POLLUTANTS AND GREENHOUSE GASES FROM NATURAL GAS COMBUSTION^a

Pollutant	Emission Factor (lb/10 ⁶ scf)	Emission Factor Rating
CO ₂ ^b	120,000	A
Lead	0.0005	D
N ₂ O (Uncontrolled)	2.2	E
N ₂ O (Controlled-low-NO _x burner)	0.64	E
PM (Total) ^c	7.6	D
PM (Condensable) ^c	5.7	D
PM (Filterable) ^c	1.9	B
SO ₂ ^d	0.6	A
TOC	11	B
Methane	2.3	B
VOC	5.5	C

^a Reference 11. Units are in pounds of pollutant per million standard cubic feet of natural gas fired. Data are for all natural gas combustion sources. To convert from lb/10⁶ scf to kg/10⁶ m³, multiply by 16. To convert from lb/10⁶ scf to lb/MMBtu, divide by 1,020. The emission factors in this table may be converted to other natural gas heating values by multiplying the given emission factor by the ratio of the specified heating value to this average heating value. TOC = Total Organic Compounds. VOC = Volatile Organic Compounds.

^b Based on approximately 100% conversion of fuel carbon to CO₂. CO₂[lb/10⁶ scf] = (3.67) (CON) (C)(D), where CON = fractional conversion of fuel carbon to CO₂, C = carbon content of fuel by weight (0.76), and D = density of fuel, 4.2x10⁴ lb/10⁶ scf.

^c All PM (total, condensable, and filterable) is assumed to be less than 1.0 micrometer in diameter. Therefore, the PM emission factors presented here may be used to estimate PM₁₀, PM_{2.5} or PM₁ emissions. Total PM is the sum of the filterable PM and condensable PM. Condensable PM is the particulate matter collected using EPA Method 202 (or equivalent). Filterable PM is the particulate matter collected on, or prior to, the filter of an EPA Method 5 (or equivalent) sampling train.

^d Based on 100% conversion of fuel sulfur to SO₂. Assumes sulfur content is natural gas of 2,000 grains/10⁶ scf. The SO₂ emission factor in this table can be converted to other natural gas sulfur contents by multiplying the SO₂ emission factor by the ratio of the site-specific sulfur content (grains/10⁶ scf) to 2,000 grains/10⁶ scf.



ATTACHMENT E-7

Cleaver-Brooks Boiler Expected Emission Data

Cleaver-Brooks Boiler Expected Emission Data					
Date Author Customer City & State	Producing Steam Firing		Nat Gas		
	BACKGROUND INFORMATION			Boiler Model	CB(LE)
	02/11/16	Chris Mays	Operating Pressure (psig)	275.00	
	Nick Reuter	Virginia Beach, VA	Furnace Volume (cuft)	230.17	
			Furnace Heat Release (btu/hr/cu ft)	154,600	
			Heating Surface (sqft)	3500	
			Nox System	60	
Nat Gas		Firing Rate			
		25%	50%	75%	100%
Horsepower		200	400	600	800
Input, Btu/hr		8,398,000	16,477,000	24,739,000	33,057,000
CO	ppm	50	50	50	50
	lb/MMBtu	0.0375	0.0375	0.0375	0.0375
	lb/hr	0.31	0.62	0.93	1.24
	tpy	1.379	2.705	4.061	5.427
NOx	ppm	60	60	60	60
	lb/MMBtu	0.0700	0.0700	0.0700	0.0700
	lb/hr	0.59	1.15	1.73	2.31
	tpy	2.575	5.052	7.585	10.135
NO	ppm	51.0	51.0	51.0	51.0
	lb/MMBtu	0.060	0.060	0.060	0.060
	lb/hr	0.50	0.98	1.47	1.97
	tpy	2.06	4.04	6.07	8.11
NO₂	ppm	9.0	9.0	9.0	9.0
	lb/MMBtu	0.011	0.011	0.011	0.011
	lb/hr	0.09	0.17	0.26	0.35
	tpy	0.51	1.01	1.52	2.03
SOx	ppm	0.34	0.34	0.34	0.34
	lb/MMBtu	0.0006	0.0006	0.0006	0.0006
	lb/hr	0.0049	0.0097	0.0146	0.0195
	tpy	0.022	0.042	0.064	0.085
VOCs	ppm	8	8	8	8
(Non-Methane Only)	lb/MMBtu	0.0036	0.0036	0.0036	0.0036
	lb/hr	0.030	0.059	0.088	0.118
	tpy	0.131	0.257	0.386	0.516
VOCs does not include any background VOC emissions.					
PM10 (Filterable)	ppm	N/A	N/A	N/A	N/A
	lb/MMBtu	0.0019	0.0019	0.0019	0.0019
	lb/hr	0.016	0.031	0.046	0.062
	tpy	0.069	0.134	0.202	0.270
PM10 (Condensable)	lb/MMBtu	0.0056	0.0056	0.0056	0.0056
	lb/hr	0.047	0.092	0.138	0.185
	tpy	0.206	0.403	0.606	0.809
PM2.5 (Filterable)	lb/MMBtu	0.0019	0.0019	0.0019	0.0019
	lb/hr	0.016	0.031	0.046	0.062
	tpy	0.069	0.134	0.202	0.270
PM2.5 (Condensable)	lb/MMBtu	0.0056	0.0056	0.0056	0.0056
	lb/hr	0.047	0.092	0.138	0.185
	tpy	0.206	0.403	0.606	0.809
Exhaust Data					
Temperature, F		426	438	449	461
Flow	ACFM	3,134	5,355	8,148	11,032
	SCFM (70 Degrees Fah.)	1,917	3,232	4,853	6,484
	DSCFM	1,733	2,870	4,309	5,758
	lb/hr	8,627	14,545	21,837	29,179
Velocity	ft/sec	16.63	28.41	43.23	58.52
	ft/min	998	1,705	2,594	3,511

Notes:

- 1) All ppm levels are corrected to dry at 3% oxygen.
- 2) Emission data based on actual boiler efficiency.
- 3) % H₂O , by volume in exhaust gas is **17.24** % O₂, by volume **2.47**
- 4) Water vapor in exhaust gas is **98.91** lbs/MMBtu of fuel fired
- 5) CO₂ produced is **116.31** lbs/MMBtu of fuel fired
- 6) Particulate is exclusive of any particulates in combustion air or other sources of residual particulates from material.
PM level indicated on this form is based on combustion air and fuel being clean and turndown up to 4:1.
- 7) Heat input is based on high heating value (HHV).
- 8.) Emission produced in tons per year (tpy) is based on 24 hours per day for 365 days = 8,760 hours per year
- 9.) Exhaust data is based on a clean and properly sealed boiler.
- 10.) Emission data is based on a burner turndown of 4 to 1, However the burner is capable of a higher turndown.

14) Fuel High Heating Value =

1000

Btu/FT³