



October 21, 2016

Assistant Director for Permitting
WV Department of Environmental Protection
Division of Air Quality
601 57th Street, SE
Charleston, WV 25304

**SUBJECT: Antero Midstream LLC – Nichols Compressor Station
West Virginia Department of Environmental Protection, Division of Air
Quality, 45CSR13 Air Permit Modification R13-3201B**

To Whom it May Concern:

On behalf of Antero Midstream LLC, please find attached the 45CSR13 Air Permit Modification for permit number R13-3201B for the Nichols Compressor Station (Facility ID 017-00114) located in Doddridge County, West Virginia. A summary of the modifications in this application include:

1. Increasing the dehydrator throughput to 110 MMscfd per dehydrator,
2. Adding a fuel conditioning heater (0.5 MMBtu/hr capacity),
3. Increasing the size of the settling tank to 500 barrels, and
4. Modifying compressor blowdown and pigging events based on expected operations and updating fugitive component counts based on updated engineering data.

With these emission-related modifications, Antero also requests that conditions 5.4.1 and 8.2.1 of R13-3201B be removed from the permit. Condition 5.4.1 requires the fuel used by the compressor engines and generator be monitored and recorded. This requirement is no longer necessary since the compressor engines and generator no longer have an operational restriction (i.e., fuel use or hours). Condition 8.2.1 requires the throughput to the vapor recovery units be monitored. The throughput to the vapor recovery units is directly dependent on the facility liquids production already being monitored for the storage tanks and loading, therefore compliance for the VRUs is demonstrated through monitoring the liquids throughput.

Enclosed are one hardcopy and two CDs containing the entire permit application including the application form and required attachments. Per 45CSR22, a \$3,500 application fee is also enclosed, which covers the base 45CSR13 \$1,000 application fee and an additional \$2,500 for Hazardous Air Pollutant requirements.

A copy of the Air Quality Permit Notice for the advertisement is included as Attachment P. As the Notice is being submitted simultaneously with the application, the official affidavit of publication will be submitted to the Division of Air Quality separately once it is completed.

Please call if you have any questions or if I can be of further assistance. I can be reached at (719) 632-3593 or by email at msteyskal@kleinfelder.com.

Sincerely,
KLEINFELDER

Michele Steyskal

Michele Steyskal
Air Quality Specialist

Enclosure: Nichols Compressor Station R13-3201B Air Permit Modification

Antero Midstream LLC

Nichols Compressor Station

**NSR Permit Application R13-3201B Modification
West Virginia Department of Environmental Protection
Division of Air Quality
45CSR13**

Doddridge County, West Virginia

October 2016

Prepared by:



**1801 California Street, Suite 1100
Denver, CO 80202
(303) 237-6601
Fax (303) 237-6602
www.kleinfelder.com**

© 2016 Kleinfelder
DEN16O46143

Table of Contents

	45CSR13 Application Form
	Discussion of Nearby Facilities
Attachment A.	Business Certificate
Attachment B.	Area Map
Attachment C.	Installation and Startup Schedule
Attachment D.	Regulatory Discussion
Attachment E.	Plot Plan
Attachment F.	Process Flow Diagram
Attachment G.	Process Description
Attachment H.	Material Safety Data Sheets
Attachment I.	Emission Units Table
Attachment J.	Emission Point Data Summary Sheet
Attachment K.	Fugitive Emissions Data Summary Sheet
Attachment L.	Emissions Unit Data Sheets
	a. Dehydrators
	b. Fuel Conditioning Heater
	c. Settling Tank
	d. Fugitives
Attachment N.	Supporting Emissions Calculations
	a. Emission Calculations
	b. GLYCalc 4.0
	c. Tanks 4.09d
Attachment O.	Monitoring, Recordkeeping, Reporting, and Testing Plans
Attachment P.	Public Notice
Attachment R.	Authority/Delegation of Authority



WEST VIRGINIA DEPARTMENT OF ENVIRONMENTAL PROTECTION
DIVISION OF AIR QUALITY

601 57th Street, SE
Charleston, WV 25304
(304) 926-0475
www.dep.wv.gov/daq

**APPLICATION FOR NSR PERMIT
AND
TITLE V PERMIT REVISION
(OPTIONAL)**

PLEASE CHECK ALL THAT APPLY TO **NSR (45CSR13)** (IF KNOWN):

- CONSTRUCTION MODIFICATION RELOCATION
 CLASS I ADMINISTRATIVE UPDATE TEMPORARY
 CLASS II ADMINISTRATIVE UPDATE AFTER-THE-FACT

PLEASE CHECK TYPE OF **45CSR30 (TITLE V)** REVISION (IF ANY):

- ADMINISTRATIVE AMENDMENT MINOR MODIFICATION
 SIGNIFICANT MODIFICATION

IF ANY BOX ABOVE IS CHECKED, INCLUDE TITLE V REVISION INFORMATION AS **ATTACHMENT S** TO THIS APPLICATION

FOR TITLE V FACILITIES ONLY: Please refer to "Title V Revision Guidance" in order to determine your Title V Revision options (Appendix A, "Title V Permit Revision Flowchart") and ability to operate with the changes requested in this Permit Application.

Section I. General

1. Name of applicant (as registered with the WV Secretary of State's Office): Antero Midstream LLC		2. Federal Employer ID No. (FEIN): 46-5517375	
3. Name of facility (if different from above): Nichols Compressor Station		4. The applicant is the: <input type="checkbox"/> OWNER <input type="checkbox"/> OPERATOR <input checked="" type="checkbox"/> BOTH	
5A. Applicant's mailing address: 1615 Wynkoop Street Denver, CO 80202		5B. Facility's present physical address: 2189 Long Run Road Greenwood, WV 26415	
6. West Virginia Business Registration. Is the applicant a resident of the State of West Virginia? <input type="checkbox"/> YES <input checked="" type="checkbox"/> NO – If YES, provide a copy of the Certificate of Incorporation/Organization/Limited Partnership (one page) including any name change amendments or other Business Registration Certificate as Attachment A . – If NO, provide a copy of the Certificate of Authority/Authority of L.L.C./Registration (one page) including any name change amendments or other Business Certificate as Attachment A .			
7. If applicant is a subsidiary corporation, please provide the name of parent corporation:			
8. Does the applicant own, lease, have an option to buy or otherwise have control of the <i>proposed site</i> ? <input checked="" type="checkbox"/> YES <input type="checkbox"/> NO – If YES, please explain: Antero Midstream LLC owns the land for the site – If NO, you are not eligible for a permit for this source.			
9. Type of plant or facility (stationary source) to be constructed, modified, relocated, administratively updated or temporarily permitted (e.g., coal preparation plant, primary crusher, etc.): Natural Gas Compressor Station		10. North American Industry Classification System (NAICS) code for the facility: 221210	
11A. DAQ Plant ID No. (for existing facilities only): 017-00114		11B. List all current 45CSR13 and 45CSR30 (Title V) permit numbers associated with this process (for existing facilities only): R13-3201B	

All of the required forms and additional information can be found under the Permitting Section of DAQ's website, or requested by phone.

<p>12A.</p> <ul style="list-style-type: none"> For Modifications, Administrative Updates or Temporary permits at an existing facility, please provide directions to the <i>present location</i> of the facility from the nearest state road; For Construction or Relocation permits, please provide directions to the <i>proposed new site location</i> from the nearest state road. Include a MAP as Attachment B. <p>Take US-50 towards Greenwood, WV. Head northwest on CR-50/30 (Sunnyside Road) for 0.3 miles. Make the first right and head east on CR-36 (Duckworth Road) for 1.0 miles. Turn left and head north on CR-26 (Long Run Road) for 1.1 miles. Turn left onto access road and reach facility in 0.3 miles.</p>		
<p>12.B. New site address (if applicable):</p> <p>2189 Long Run Road Greenwood, WV 26415</p>	<p>12C. Nearest city or town:</p> <p>Pennsboro</p>	<p>12D. County:</p> <p>Doddridge</p>
<p>12.E. UTM Northing (KM): 4349.253</p>	<p>12F. UTM Easting (KM): 511.253</p>	<p>12G. UTM Zone: 17</p>
<p>13. Briefly describe the proposed change(s) at the facility:</p> <p>The dehydrator throughput has been increased to 110 MMscfd per dehydrator, the settling tank size is 500 barrels, a fuel conditioning heater has been added, and venting and blowdown events updated based on expected operations.</p>		
<p>14A. Provide the date of anticipated installation or change: Upon Permit Issuance</p> <ul style="list-style-type: none"> If this is an After-The-Fact permit application, provide the date upon which the proposed change did happen: / / 	<p>14B. Date of anticipated Start-Up if a permit is granted:</p> <p>January 2017</p>	
<p>14C. Provide a Schedule of the planned Installation of/Change to and Start-Up of each of the units proposed in this permit application as Attachment C (if more than one unit is involved).</p>		
<p>15. Provide maximum projected Operating Schedule of activity/activities outlined in this application:</p> <p>Hours Per Day 24 Days Per Week 7 Weeks Per Year 52</p>		
<p>16. Is demolition or physical renovation at an existing facility involved? <input type="checkbox"/> YES <input checked="" type="checkbox"/> NO</p>		
<p>17. Risk Management Plans. If this facility is subject to 112(r) of the 1990 CAAA, or will become subject due to proposed changes (for applicability help see www.epa.gov/ceppo), submit your Risk Management Plan (RMP) to U. S. EPA Region III.</p>		
<p>18. Regulatory Discussion. List all Federal and State air pollution control regulations that you believe are applicable to the proposed process (<i>if known</i>). A list of possible applicable requirements is also included in Attachment S of this application (Title V Permit Revision Information). Discuss applicability and proposed demonstration(s) of compliance (<i>if known</i>). Provide this information as Attachment D.</p>		
<p><i>Section II. Additional attachments and supporting documents.</i></p>		
<p>19. Include a check payable to WVDEP – Division of Air Quality with the appropriate application fee (per 45CSR22 and 45CSR13).</p>		
<p>20. Include a Table of Contents as the first page of your application package.</p>		
<p>21. Provide a Plot Plan, e.g. scaled map(s) and/or sketch(es) showing the location of the property on which the stationary source(s) is or is to be located as Attachment E (Refer to Plot Plan Guidance) .</p> <ul style="list-style-type: none"> Indicate the location of the nearest occupied structure (e.g. church, school, business, residence). 		
<p>22. Provide a Detailed Process Flow Diagram(s) showing each proposed or modified emissions unit, emission point and control device as Attachment F.</p>		
<p>23. Provide a Process Description as Attachment G.</p> <ul style="list-style-type: none"> Also describe and quantify to the extent possible all changes made to the facility since the last permit review (if applicable). 		
<p>All of the required forms and additional information can be found under the Permitting Section of DAQ's website, or requested by phone.</p>		

24. Provide **Material Safety Data Sheets (MSDS)** for all materials processed, used or produced as **Attachment H**.
 – For chemical processes, provide a MSDS for each compound emitted to the air.

25. Fill out the **Emission Units Table** and provide it as **Attachment I**.

26. Fill out the **Emission Points Data Summary Sheet (Table 1 and Table 2)** and provide it as **Attachment J**.

27. Fill out the **Fugitive Emissions Data Summary Sheet** and provide it as **Attachment K**.

28. Check all applicable **Emissions Unit Data Sheets** listed below:

<input type="checkbox"/> Bulk Liquid Transfer Operations	<input type="checkbox"/> Haul Road Emissions	<input type="checkbox"/> Quarry
<input checked="" type="checkbox"/> Chemical Processes	<input type="checkbox"/> Hot Mix Asphalt Plant	<input type="checkbox"/> Solid Materials Sizing, Handling and Storage Facilities
<input type="checkbox"/> Concrete Batch Plant	<input type="checkbox"/> Incinerator	<input checked="" type="checkbox"/> Storage Tanks
<input type="checkbox"/> Grey Iron and Steel Foundry	<input type="checkbox"/> Indirect Heat Exchanger	

General Emission Unit, specify: **Dehydrator, Fuel Conditioning Heater**

Fill out and provide the **Emissions Unit Data Sheet(s)** as **Attachment L**.

29. Check all applicable **Air Pollution Control Device Sheets** listed below:

<input type="checkbox"/> Absorption Systems	<input type="checkbox"/> Baghouse	<input type="checkbox"/> Flare
<input type="checkbox"/> Adsorption Systems	<input type="checkbox"/> Condenser	<input type="checkbox"/> Mechanical Collector
<input type="checkbox"/> Afterburner	<input type="checkbox"/> Electrostatic Precipitator	<input type="checkbox"/> Wet Collecting System

Other Collectors, specify :

Fill out and provide the **Air Pollution Control Device Sheet(s)** as **Attachment M**.

30. Provide all **Supporting Emissions Calculations** as **Attachment N**, or attach the calculations directly to the forms listed in Items 28 through 31.

31. **Monitoring, Recordkeeping, Reporting and Testing Plans.** Attach proposed monitoring, recordkeeping, reporting and testing plans in order to demonstrate compliance with the proposed emissions limits and operating parameters in this permit application. Provide this information as **Attachment O**.

➤ Please be aware that all permits must be practically enforceable whether or not the applicant chooses to propose such measures. Additionally, the DAQ may not be able to accept all measures proposed by the applicant. If none of these plans are proposed by the applicant, DAQ will develop such plans and include them in the permit.

32. **Public Notice.** At the time that the application is submitted, place a **Class I Legal Advertisement** in a newspaper of general circulation in the area where the source is or will be located (See 45CSR§13-8.3 through 45CSR§13-8.5 and **Example Legal Advertisement** for details). Please submit the **Affidavit of Publication** as **Attachment P** immediately upon receipt.

33. **Business Confidentiality Claims.** Does this application include confidential information (per 45CSR31)?

YES NO

➤ If **YES**, identify each segment of information on each page that is submitted as confidential and provide justification for each segment claimed confidential, including the criteria under 45CSR§31-4.1, and in accordance with the DAQ's "**Precautionary Notice – Claims of Confidentiality**" guidance found in the **General Instructions** as **Attachment Q**.

Section III. Certification of Information

34. **Authority/Delegation of Authority.** Only required when someone other than the responsible official signs the application. Check applicable **Authority Form** below:

<input type="checkbox"/> Authority of Corporation or Other Business Entity	<input type="checkbox"/> Authority of Partnership
<input type="checkbox"/> Authority of Governmental Agency	<input type="checkbox"/> Authority of Limited Partnership

Submit completed and signed **Authority Form** as **Attachment R**.

All of the required forms and additional information can be found under the Permitting Section of DAQ's website, or requested by phone.

35A. **Certification of Information.** To certify this permit application, a Responsible Official (per 45CSR§13-2.22 and 45CSR§30-2.28) or Authorized Representative shall check the appropriate box and sign below.

Certification of Truth, Accuracy, and Completeness

I, the undersigned **Responsible Official** / **Authorized Representative**, hereby certify that all information contained in this application and any supporting documents appended hereto, is true, accurate, and complete based on information and belief after reasonable inquiry I further agree to assume responsibility for the construction, modification and/or relocation and operation of the stationary source described herein in accordance with this application and any amendments thereto, as well as the Department of Environmental Protection, Division of Air Quality permit issued in accordance with this application, along with all applicable rules and regulations of the West Virginia Division of Air Quality and W.Va. Code § 22-5-1 et seq. (State Air Pollution Control Act). If the business or agency changes its Responsible Official or Authorized Representative, the Director of the Division of Air Quality will be notified in writing within 30 days of the official change.

Compliance Certification

Except for requirements identified in the Title V Application for which compliance is not achieved, I, the undersigned hereby certify that, based on information and belief formed after reasonable inquiry, all air contaminant sources identified in this application are in compliance with all applicable requirements.

SIGNATURE Ward McNeilly
(Please use blue ink)

DATE: 10/14/16
(Please use blue ink)

35B. Printed name of signee: Ward McNeilly

35C. Title: Vice President, Reserves Planning and Midstream

35D. E-mail: wmcneilly@anteroresources.com

36E. Phone: (303)357-6822

36F. FAX: (303)357-7315

36A. Printed name of contact person (if different from above): Barry Schatz

36B. Title: Senior Environmental and Regulatory Manager

36C. E-mail: bschatz@anteroresources.com

36D. Phone: (303) 357-7276

36E. FAX: (303)357-7315

PLEASE CHECK ALL APPLICABLE ATTACHMENTS INCLUDED WITH THIS PERMIT APPLICATION:

- | | |
|--|--|
| <input checked="" type="checkbox"/> Attachment A: Business Certificate | <input checked="" type="checkbox"/> Attachment K: Fugitive Emissions Data Summary Sheet |
| <input checked="" type="checkbox"/> Attachment B: Map(s) | <input checked="" type="checkbox"/> Attachment L: Emissions Unit Data Sheet(s) |
| <input checked="" type="checkbox"/> Attachment C: Installation and Start Up Schedule | <input type="checkbox"/> Attachment M: Air Pollution Control Device Sheet(s) |
| <input checked="" type="checkbox"/> Attachment D: Regulatory Discussion | <input checked="" type="checkbox"/> Attachment N: Supporting Emissions Calculations |
| <input checked="" type="checkbox"/> Attachment E: Plot Plan | <input checked="" type="checkbox"/> Attachment O: Monitoring/Recordkeeping/Reporting/Testing Plans |
| <input checked="" type="checkbox"/> Attachment F: Detailed Process Flow Diagram(s) | <input checked="" type="checkbox"/> Attachment P: Public Notice |
| <input checked="" type="checkbox"/> Attachment G: Process Description | <input type="checkbox"/> Attachment Q: Business Confidential Claims |
| <input checked="" type="checkbox"/> Attachment H: Material Safety Data Sheets (MSDS) | <input checked="" type="checkbox"/> Attachment R: Authority Forms |
| <input checked="" type="checkbox"/> Attachment I: Emission Units Table | <input type="checkbox"/> Attachment S: Title V Permit Revision Information |
| <input checked="" type="checkbox"/> Attachment J: Emission Points Data Summary Sheet | <input checked="" type="checkbox"/> Application Fee |

Please mail an original and three (3) copies of the complete permit application with the signature(s) to the DAQ, Permitting Section, at the address listed on the first page of this application. Please DO NOT fax permit applications.

FOR AGENCY USE ONLY – IF THIS IS A TITLE V SOURCE:

- Forward 1 copy of the application to the Title V Permitting Group and:
- For Title V Administrative Amendments:
 - NSR permit writer should notify Title V permit writer of draft permit,
- For Title V Minor Modifications:
 - Title V permit writer should send appropriate notification to EPA and affected states within 5 days of receipt,
 - NSR permit writer should notify Title V permit writer of draft permit.
- For Title V Significant Modifications processed in parallel with NSR Permit revision:
 - NSR permit writer should notify a Title V permit writer of draft permit,
 - Public notice should reference both 45CSR13 and Title V permits,
 - EPA has 45 day review period of a draft permit.

All of the required forms and additional information can be found under the Permitting Section of DAQ's website, or requested by phone.

Discussion of Nearby Facilities

Nichols Compressor Station – Closest Antero Facilities

1. Common Control: Only those facilities that are owned and managed by Antero were included in the aggregation discussion. This includes Antero Resources Corporation production facilities in addition to the Antero Midstream LLC midstream facilities.
2. SIC Code: The Nichols Compressor Station will operate under SIC code 4923 (natural gas distribution). The closest facility owned by Antero Midstream LLC with this SIC code is the Tamela Compressor station which is 2.7 miles northeast of the Facility. All Antero Resources Corporation production facilities operate under the SIC code of 1311 (crude petroleum and natural gas extraction). The closest facility operated by Antero Resources Corporation with the SIC code of 1311 is the Vogt Pad 1.1 miles to the southeast.
3. Contiguous or Adjacent: The land between the Nichols Compressor Station and its nearest facility operating under SIC code 4923 is not owned or managed by Antero Midstream LLC or Antero Resources Corporation. Therefore, the two facilities are not contiguous or adjacent.

Based on this three-pronged evaluation, although the Nichols Compressor Station and Tamela Compressor Station do belong to the same major industrial group, they should not be aggregated because they are not contiguous or adjacent.

The Nichols Compressor Station and Vogt Pad should not be aggregated because they do not belong to the same major industrial group and do not directly rely on each other nor are they contiguous or adjacent.



 <p>KLEINFELDER Bright People. Right Solutions. www.kleinfelder.com</p>	PROJECT NO. 20161767.001A	Antero Midstream LLC	FIGURE
	DRAWN: 1/20/2016		
	DRAWN BY: B. McDavid	Nichols Compressor Station Doddridge County, West Virginia	
	CHECKED BY: M. Steyskal		
	FILE NAME: Nichols_ClosestReceptor.mxd		

**Attachment A.
Business Certificate**

State of West Virginia

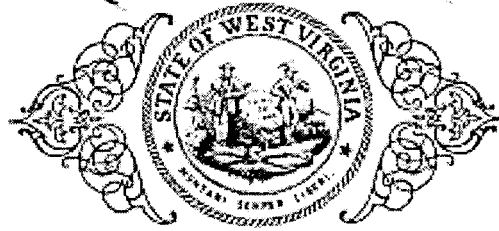

Certificate

LAB

I, Natalie E. Tennant, Secretary of State of the State of West Virginia, hereby certify that

ANTERO MIDSTREAM LLC

Control Number: 9A5E1

a limited liability company, organized under the laws of the State of Delaware has filed its "Application for Certificate of Authority" in my office according to the provisions of West Virginia Code §31B-10-1002. I hereby declare the organization to be registered as a foreign limited liability company from its effective date of April 29, 2014, until a certificate of cancellation is filed with our office.

Therefore, I hereby issue this

CERTIFICATE OF AUTHORITY OF A FOREIGN LIMITED LIABILITY COMPANY

to the limited liability company authorizing it to transact business in West Virginia

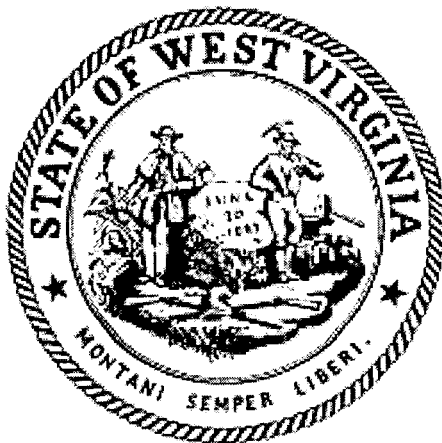

Given under my hand and the Great Seal of the State of West Virginia on this day of April 29, 2014

Natalie E. Tennant

Secretary of State

FILED

APR 29 2014

IN THE OFFICE OF
WV SECRETARY OF STATE

Submitted by:
CT Corporation Rep-Terry Stamper
Terry.Stamper@wolterskluwer.com
304-776-1152

1152

Natafie E. Tennant
Secretary of State
1900 Kanawha Blvd E
Bldg 1, Suite 157-K
Charleston, WV 25305



Penney Barker, Manager
Corporations Division
Tel: (304)558-8000
Fax: (304)558-8381
Website: www.wvsos.com
E-mail: business@wvsos.com

WV APPLICATION FOR
CERTIFICATE OF AUTHORITY OF
LIMITED LIABILITY COMPANY

FILE ONE ORIGINAL.
(Two if you want a filed
stamped copy returned to you)
FEE: \$150

Office Hours: Monday - Friday
8:30 a.m. - 5:00 p.m. ET

Control # WABE1

1. The name of the company as registered in its home state is: Antero Midstream LLC

and the state or country of organization is: Delaware

CHECK HERE to indicate you have obtained and submitted with this application a **CERTIFICATE OF EXISTENCE (GOOD STANDING)**, dated during the current tax year, from your home state of original incorporation as required to process your application. The certificate may be obtained by contacting the Secretary of State's Office in the home state of original incorporation.

2. The name to be used in West Virginia will be: Home State name as listed above, if available in WV (If name is not available, check DBA Name box below and follow special instructions in Section 2. attached.)
 DBA name _____
(See special instructions in Section 2. Regarding the Letter of Resolution attached to this application.)

3. The company will be a: [See instructions for limitations on professions which may form P.L.L.C. in WV. All members must have WV professional license. In most cases, a Letter of Authorization/Approval from the appropriate State Licensing Board is required to process the application.]
 regular L.L.C.
 Professional L.L.C. for the profession of _____

4. The street address of the principal office is: No. & Street: 1625 17th Street, Suite 300
City/State/Zip: Denver, Colorado 80202
and the mailing address (if different) is: Street/Box: _____
City/State/Zip: _____

5. The address of the designated office of the company in WV, if any, will be: No. & Street: 5400 D Big Tyler Road
City/State/Zip: Charleston, West Virginia 25313

6. Agent of Process: Properly designated person to whom notice of legal process may be sent, if any: Name: C T Corporation System
Address: 5400 D Big Tyler Road
City/State/Zip: Charleston, West Virginia 25313

RECEIVED
APR 29 2014

7. E-mail address where business correspondence may be received: jgiannaula@anteroresources.com

8. Website address of the business, if any: N/A

9. The company is: an at-will company, for an indefinite period
 a term company, for the term of _____ years,
 which will expire on _____.

10. The company is: member-managed. [List the names and addresses of all members.]
 manager-managed. [List the names and addresses of all managers.]

List the Name(s) and Address(es) of the Member(s)/Manager(s) of the company (attach additional pages if necessary).

Name	Street Address	City, State, Zip
Antero Resources Corporation	1625 17th Street, Suite 300	Denver, Colorado 80202

11. All or specified members of a limited liability company are liable in their capacity as members for all or specified debts, obligations or liabilities of the company. No--All debts, obligations and liabilities are those of the company.
 Yes--Those persons who are liable in their capacity as members for all debts, obligations or liability of the company have consented in writing to the adoption of the provision or to be bound by the provision.

12. The purpose for which this limited liability company is formed are as follows:
 (Describe the type(s) of business activity which will be conducted, for example, "real estate," "construction of residential and commercial buildings," "commercial printing," "professional practice of architecture.")
Midstream oil and gas operating company

13. Is the business a Scrap Metal Dealer?
 Yes [If "Yes," you must complete the Scrap Metal Dealer Registration Form (Form SMD-1) and proceed to question 14.]
 No [Proceed to question 14.]

14. The number of pages attached and included in this application is: 3

15. The requested effective date is: the date & time of filing in the Secretary of State's Office
[Requested date may not be earlier than
filing nor later than 90 days after filing
in our office.] the following date _____ and time _____

16. Contact and Signature Information* (See below Important Legal Notice Regarding Signature):

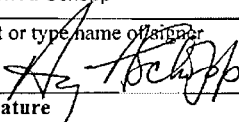
a.	Alvyn A. Schopp	(313) 357-7310
	_____	_____
	Contact Name	Phone Number
b.	Alvyn A. Schopp	Chief Administrative Officer and Regional Vice President
	_____	_____
	Print or type name of signer	Title / Capacity of Signer
c.		April 28, 2014
	_____	_____
	Signature	Date

***Important Legal Notice Regarding Signature:** Per West Virginia Code §31B-2-209. Liability for false statement in filed record. If a record authorized or required to be filed under this chapter contains a false statement, one who suffers loss by reliance on the statement may recover damages for the loss from a person who signed the record or caused another to sign it on the person's behalf and knew the statement to be false at the time the record was signed.

Delaware

PAGE 1

The First State

I, JEFFREY W. BULLOCK, SECRETARY OF STATE OF THE STATE OF DELAWARE, DO HEREBY CERTIFY "ANTERO MIDSTREAM LLC" IS DULY FORMED UNDER THE LAWS OF THE STATE OF DELAWARE AND IS IN GOOD STANDING AND HAS A LEGAL EXISTENCE SO FAR AS THE RECORDS OF THIS OFFICE SHOW, AS OF THE TWENTY-NINTH DAY OF APRIL, A.D. 2014.

AND I DO HEREBY FURTHER CERTIFY THAT THE ANNUAL TAXES HAVE NOT BEEN ASSESSED TO DATE.

5466900 8300

140532521

You may verify this certificate online
at corp.delaware.gov/authver.shtml

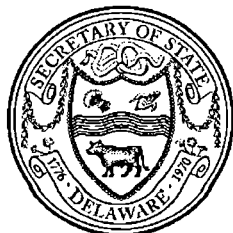



Jeffrey W. Bullock, Secretary of State
AUTHENTICATION: 1328067

DATE: 04-29-14

**Attachment B.
Area Map**

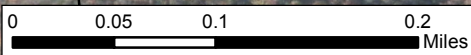

The information included on this graphic representation has been compiled from a variety of sources and is subject to change without notice. Kleinfelder makes no representations or warranties, express or implied, as to accuracy, completeness, timeliness, or rights to the use of such information. This document is not intended for use as a land survey product nor is it designed or intended as a construction design document. The use or misuse of the information contained on this graphic representation is at the sole risk of the party using or misusing the information.



Source: Esri, DigitalGlobe, GeoEye, IGN, CNES/Airbus DS, USDA, USGS, AeroGRID, IGN, swisstopo, and the GIS User Community

Legend

- Nichols Compressor Station
- Receptor
- Existing Road
- County Boundary

<p>KLEINFELDER Bright People. Right Solutions. www.kleinfelder.com</p>	PROJECT NO. 20152866	Antero Midstream LLC	FIGURE
	DRAWN: 10/23/2014		
	DRAWN BY: J. Weber	Nichols Compressor Station Doddridge County, West Virginia	
	CHECKED BY: K.Meszaros		
FILE NAME: NicholsCS_Receptor.mxd			

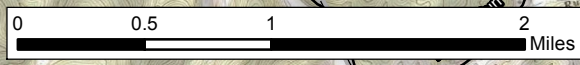
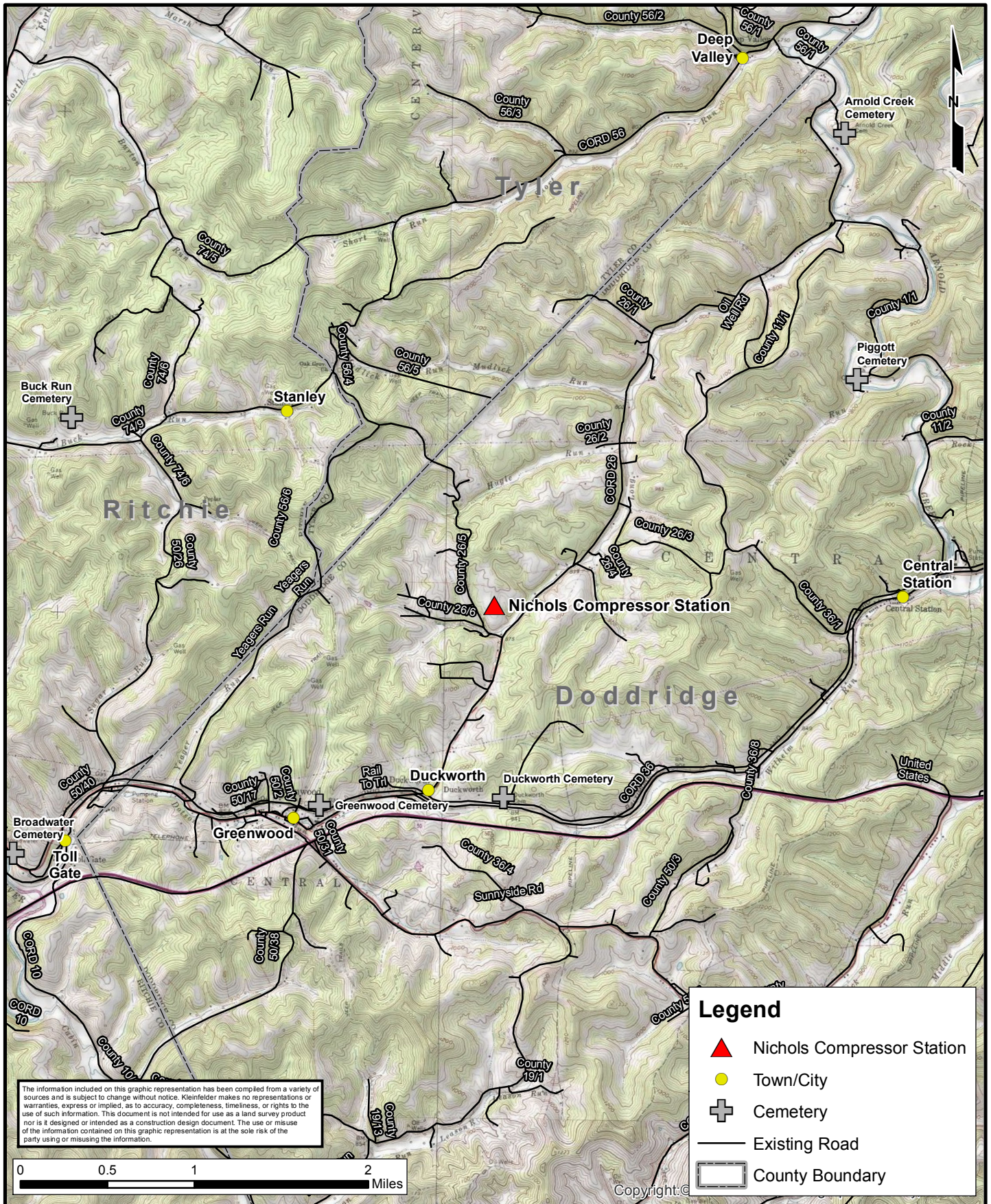

Legend

- ▲ Nichols Compressor Station
- Town/City
- ⊕ Cemetery
- Existing Road
- ▭ County Boundary

KLEINFELDER
Bright People. Right Solutions.
www.kleinfelder.com

PROJECT NO.	20152866
DRAWN:	10/23/2014
DRAWN BY:	J. Weber
CHECKED BY:	K.Meszaros
FILE NAME:	NicholsCS_Topo.mxd

Antero Midstream LLC

Nichols Compressor Station
Doddridge County, West Virginia

FIGURE

**Attachment C.
Installation and Startup Schedule**

Nichols Compressor Station – Installation and Startup Schedule

The Nichols Compressor Station is an existing facility located in Doddridge County, WV, approximately 7.6 miles east of Pennsboro, WV. Equipment is currently installed and operating per permit R13-3201B. The proposed equipment is scheduled to be installed and operational around January 2017.

**Attachment D.
Regulatory Discussion**

Nichols Compressor Station – Regulatory Discussion

Federal Regulations

40 CFR Part 60 – Standards of Performance for New Stationary Sources

- I. *Subpart Kb - Standards of Performance for Volatile Organic Liquid Storage Vessels (Including Petroleum Liquid Storage Vessels) for Which Construction, Reconstruction, or Modification Commenced After July 23, 1984.*

Applicability: Subpart Kb applies to volatile organic liquid storage tanks with a capacity greater than or equal to 75 m³ (§60.110b(a)). However, Subpart Kb does not apply to storage vessels with a design capacity less than or equal to 1,589.874 m³ that are used for petroleum or condensate storage prior to custody transfer. The storage tanks at Nichols Compressor Station will be less than 1,589.874 m³ and will be used for storage prior to custody transfer. Therefore, Subpart Kb does not apply to the Nichols Compressor Station.

- II. *Subpart GG - Standards of Performance for Stationary Gas Turbines*

Applicability: Subpart GG applies to all stationary gas turbines with a heat input at peak load equal to or greater than 10 million BTU per hour based on the lower heating value of the fuel (§60.330(a)). Since the microturbine generators at the Nichols Compressor Station have a heat input rating less than 10 million Btu per hour, Subpart GG does not apply.

- III. *Subpart KKK - Standards of Performance for Equipment Leaks of VOC from Onshore Natural Gas Processing Plants for Which Construction, Reconstruction, or Modification Commenced After January 20, 1984, and on or Before August 23, 2011.*

Applicability: Subpart KKK applies to facilities built or modified before August 23, 2011, so Subpart KKK does not apply as the Nichols Compressor Station was constructed after that date.

- IV. *Subpart LLL - Standards of Performance for SO₂ Emissions from Onshore Natural Gas Processing for Which Construction, Reconstruction, or Modification Commenced After January 20, 1984, and on or Before August 23, 2011.*

Applicability: Subpart LLL applies to facilities built or modified before August 23, 2011, so Subpart LLL will not apply as the Nichols Compressor Station was constructed after that date.

- V. *Subpart JJJJ - Standards of Performance for Stationary Spark Ignition Internal Combustion Engines*

Applicability: Subpart JJJJ applies to rich burn engines that were ordered after June 12, 2006 and manufactured on or after July 1, 2007 for engines with maximum power

greater than or equal to 500 hp (§60.4230(a)(4)(i)). Thus, Subpart JJJJ applies to the Nichols Compressor Station as the compressor engines were ordered after June 12, 2006 and manufactured after July 1, 2007.

VI. Subpart KKKK - Standards of Performance for Stationary Combustion Turbines

Applicability: Subpart KKKK applies to all stationary combustion turbines with a heat input at peak load equal to or greater than 10 million BTU per hour based on the higher heating value of the fuel (§60.4305(a)). Since the microturbine generators at the Nichols Compressor Station have a heat input rating less than 10 million Btu per hour, Subpart KKKK does not apply.

VII. Subpart OOOO - Standards of Performance for Crude Oil and Natural Gas Production, Transmission and Distribution for Which Construction, Modification or Reconstruction Commenced after August 23, 2011, and on or before September 18, 2015

Applicability: Subpart OOOO applies to reciprocating compressor facilities that were constructed, modified, or reconstructed after August 23, 2011 and on or before September 18, 2015 (§60.5365(c)). Additionally, Subpart OOOO applies to storage vessel affected facilities with individual tank emissions greater than 6 tons per year (§60.5365(e)). Thus, Subpart OOOO applies to the Nichols Compressor Station as the storage tanks were constructed after August 23, 2011, but before September 18, 2015, and has a settling tank that has an uncontrolled potential to emit greater than 6 tons per year. The pneumatic controllers installed at Nichols Compressor Station are air-actuated and therefore exempt from the requirements of this subpart.

VIII. Subpart OOOOa - Standards of Performance for Crude Oil and Natural Gas Production, Transmission and Distribution for Which Construction, Modification or Reconstruction Commenced after September 18, 2015

Applicability: Subpart OOOOa applies to reciprocating compressor facilities that were constructed, modified, or reconstructed after September 18, 2015 (§60.5365a(c)). Additionally, the collection of fugitive emissions components at a compressor station is an affected facility under this Subpart (§60.5365a(j)). A modification for a compressor station under §60.5365a(j) occurs when a compressor engine is added or replaced to increase overall horsepower. Thus, Subpart OOOOa does apply to the reciprocating compressors and fugitive leak components at Nichols Compressor Station since modifications that occurred after September 18, 2015 added compression to the facility.

40 CFR Part 61 – National Emission Standards for Hazardous Air Pollutants

I. Subpart V – National Emission Standard for Equipment Leaks (Fugitive Emission Sources)

Applicability: Subpart V applies to components such as compressors, valves, and pumps that are intended to operate in volatile hazardous air pollutant (VHAP) service

(§61.240(a)). VHAP service means that a component contains or contacts a fluid that is at least 10 percent by weight a VHAP. Subpart V does not apply to the Nichols Compressor Station because none of the components have fluid (natural gas, water, or condensate) that is over 10 percent by weight of any VHAP.

40 CFR Part 63 – National Emission Standards for Hazardous Air Pollutants for Source Categories

I. Subpart HH – National Emission Standards for Hazardous Air Pollutants from Oil and Natural Gas Production Facilities

Applicability: Subpart HH applies to oil and natural gas production facilities that are a major or area source of HAP emissions, and that process, upgrade, or store hydrocarbon liquids or natural gas prior to the transmission and storage source category (§63.760(a)). Subpart HH does apply to the Nichols Compressor Station, and because it is an area source of HAP emissions, the two (2) TEG dehydrators will be applicable sources under Subpart HH (§63.760(b)(2)). However, actual benzene emissions from the dehydrators at the Nichols Compressor Station are less than 1 ton per year, so both dehydrators are exempt from all requirements except recordkeeping (§63.764(e)(1)(ii)).

II. Subpart HHH – National Emission Standards for Hazardous Air Pollutants from Natural Gas Transmission and Storage Facilities

Applicability: Subpart HHH applies to natural gas transmission and storage facilities that are a major source of HAP emissions (§63.1270(a)). Subpart HHH does not apply to the Nichols Compressor Station as it is not a major source of HAP emissions. Further, the Nichols Compressor Station is prior to the gas transmission and storage phase.

III. Subpart EEEE – National Emission Standards for Hazardous Air Pollutants: Organic Liquids Distribution (Non-Gasoline)

Applicability: Subpart EEEE applies to organic liquids distribution operations that are located at major source of HAP emissions (§63.2334(a)). Subpart EEEE does not apply to the Nichols Compressor Station as it is not a major source of HAP emissions.

IV. Subpart YYYY – National Emission Standards for Hazardous Air Pollutants for Stationary Combustion Turbines

Applicability: Subpart YYYY applies to stationary combustion turbines located at major sources of HAP emissions (§63.6085(a)). Since the Nichols Compressor Station is not a major source of HAP emissions, Subpart YYYY does not apply.

V. Subpart ZZZZ - National Emission Standards for Hazardous Air Pollutants for Stationary Reciprocating Internal Combustion Engines

Applicability: Subpart ZZZZ applies to stationary RICE at a major or area source of HAP emissions (§63.6585). Subpart ZZZZ applies to the Nichols Compressor Station as the compressor engines are new RICE. The engines will meet Subpart ZZZZ by meeting 40 CFR Part 60, Subpart JJJJ as the Nichols Compressor Station is an area source of HAP emissions (§63.6590(c)(1)).

VI. *Subpart DDDDD – National Emission Standards for Hazardous Air Pollutants for Industrial, Commercial, and Institutional Boilers and Process Heaters*

Applicability: Subpart DDDDD applies to process heaters at a major source of HAP emissions (§63.7485). Subpart DDDDD does not apply to the Nichols Compressor Station as it is not a major source of HAP emissions.

West Virginia State Regulations

Title 45 Legislative Rule – Division of Environmental Protection, Office of Air Quality

The following Title 45 Legislative Rules will be applicable to the Nichols Compressor Station:

- I. *45CSR2 – To Prevent and Control Particulate Air Pollution from Combustion of Fuel in Indirect Heat Exchangers*
- II. *45CSR2A – Testing, Monitoring, Recordkeeping and Reporting Requirements Under 45CSR2*
- III. *45CSR4 – To Prevent and Control the Discharge of Air Pollutants into the Open Air Which Causes or Contributes to an Objectionable Odor or Odors*
- IV. *45CSR6 – Control of Air Pollution from Combustion of Refuse*
- V. *45CSR8 – Ambient Air Quality Standards*
- VI. *45CSR11 – Prevention of Air Pollution Emergency Episodes*
- VII. *45CSR13 – Permits for Construction, Modification, Relocation and Operation of Stationary Sources of Air Pollutants, Notification Requirements, Administrative Updates, Temporary Permits, General Permits, and Procedures for Evaluation*
- VIII. *45CSR16 – Standards of Performance for New Stationary Sources Pursuant to 40 CFR, Part 60*
- IX. *45CSR20 – Good Engineering Practice as Applicable to Stack Heights*
- X. *45CSR22 – Air Quality Management Fee Program*
- XI. *45CSR27 – To Prevent and Control the Emissions of Toxic Air Pollutants*
- XII. *45CSR33 – Acid Rain Provisions and Permits*
- XIII. *45CSR34 – Emission Standards for Hazardous Air Pollutants for Source Categories Pursuant to 40 CFR, Part 63*
- XIV. *45CSR38 – Provisions for Determination of Compliance with Air Quality Management Rules*
- XV. *45CSR42 – Greenhouse Gas Emissions Inventory*

**Attachment E.
Plot Plan**

**Attachment F.
Process Flow Diagram**

THIS DRAWING AND THE DESIGN IT SHOWS ARE CONFIDENTIAL AND REMAIN THE PROPERTY OF ANTERO ENERGY, L.L.C. AND SHALL NOT BE DISCLOSED TO OTHERS OR REPRODUCED IN ANY MANNER OR USED FOR ANY PURPOSE WHATSOEVER EXCEPT BY AUTHORITY PROVIDED BY THE OWNER.

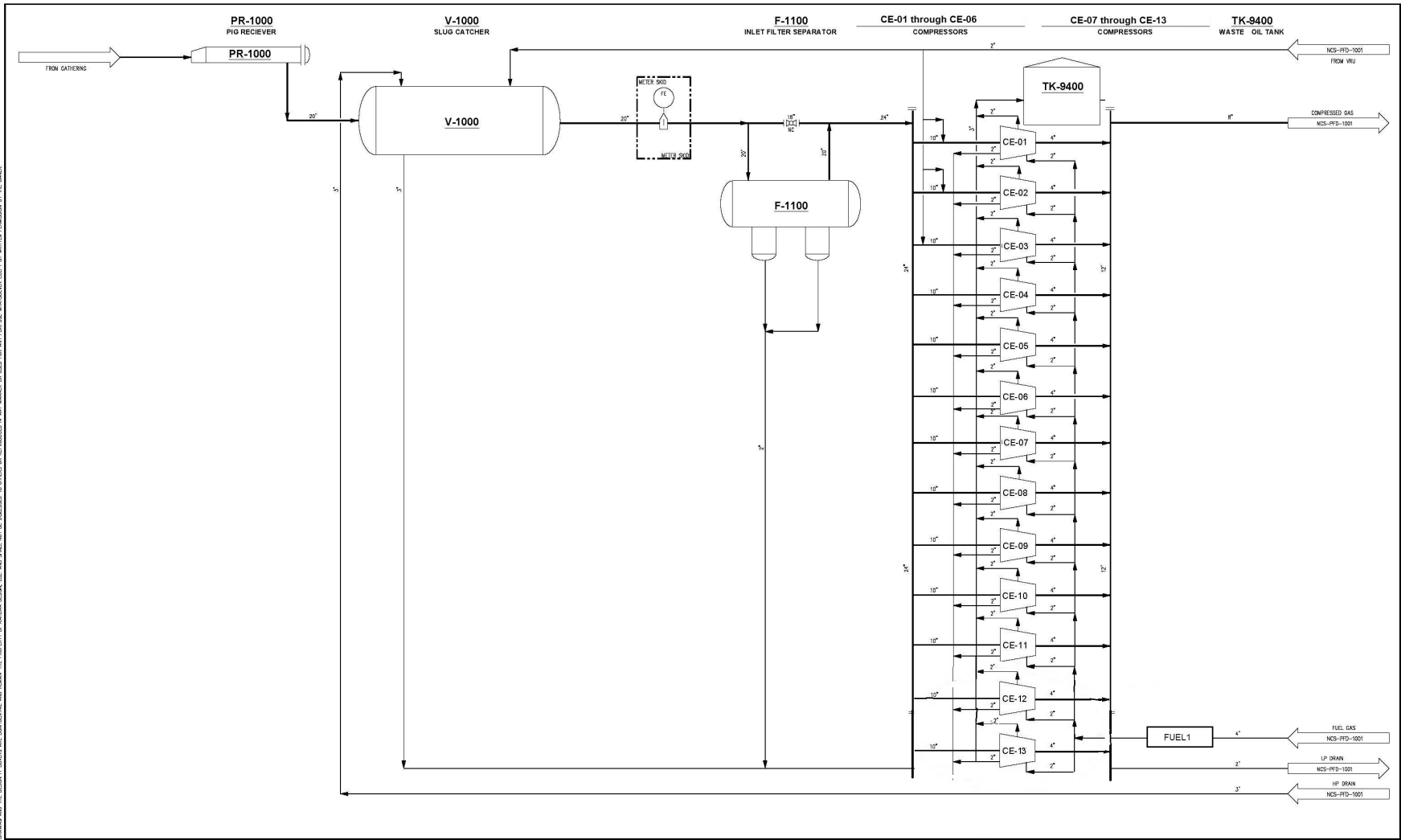

FILE LOCATION: \PROJECTS\ANTERO APALACHIAN RESERVE\NCS-PFD-1001 - NICHOLS COMPRESSOR STATION\NCS-PFD-1001.DWG LAST SAVED: 06/07/14 BY: Anna Downy PLOT TIME: DATE: Jun 18 2014

NOTES:		REFERENCE DRAWINGS		REVISIONS		 NICHOLS COMPRESSOR STATION		PROCESS FLOW DIAGRAM																																																																																																								
<table border="1"> <thead> <tr> <th>DWG. NO.</th> <th>TITLE</th> </tr> </thead> <tbody> <tr><td> </td><td> </td></tr> <tr><td> </td><td> </td></tr> <tr><td> </td><td> </td></tr> <tr><td> </td><td> </td></tr> <tr><td> </td><td> </td></tr> <tr><td> </td><td> </td></tr> <tr><td> </td><td> </td></tr> <tr><td> </td><td> </td></tr> <tr><td> </td><td> </td></tr> <tr><td> </td><td> </td></tr> </tbody> </table>	DWG. NO.	TITLE																					<table border="1"> <thead> <tr> <th>NO.</th> <th>DESCRIPTION</th> <th>BY</th> <th>CHK</th> <th>DATE</th> <th>DATE</th> <th>DATE</th> </tr> </thead> <tbody> <tr><td> </td><td> </td><td> </td><td> </td><td> </td><td> </td><td> </td></tr> <tr><td> </td><td> </td><td> </td><td> </td><td> </td><td> </td><td> </td></tr> <tr><td> </td><td> </td><td> </td><td> </td><td> </td><td> </td><td> </td></tr> <tr><td> </td><td> </td><td> </td><td> </td><td> </td><td> </td><td> </td></tr> <tr><td> </td><td> </td><td> </td><td> </td><td> </td><td> </td><td> </td></tr> <tr><td> </td><td> </td><td> </td><td> </td><td> </td><td> </td><td> </td></tr> <tr><td> </td><td> </td><td> </td><td> </td><td> </td><td> </td><td> </td></tr> <tr><td> </td><td> </td><td> </td><td> </td><td> </td><td> </td><td> </td></tr> <tr><td> </td><td> </td><td> </td><td> </td><td> </td><td> </td><td> </td></tr> <tr><td> </td><td> </td><td> </td><td> </td><td> </td><td> </td><td> </td></tr> <tr><td> </td><td> </td><td> </td><td> </td><td> </td><td> </td><td> </td></tr> </tbody> </table>	NO.	DESCRIPTION	BY	CHK	DATE	DATE	DATE																																																																														<table border="1"> <tr> <td> KAHUNA VENTURES LLC WESTMINSTER, CO 80002 303.451.7374 BY: KAHUNA DESIGN L.L.C. </td> <td> DRAWN BY: A. COOLEY CREATION DATE: 05/05/14 PLOT No.: 4083.0184.00 SCALE: NONE </td> <td> CHECKED: J. WARMAN CHECK DATE: 05/05/14 DWG. NO.: NCS-PFD-1000 </td> <td> APPROVED: P. STOCKBRAND APRR. DATE: 05/05/14 SHEET NO.: 1 OF 2 </td> </tr> </table>	 KAHUNA VENTURES LLC WESTMINSTER, CO 80002 303.451.7374 BY: KAHUNA DESIGN L.L.C.	DRAWN BY: A. COOLEY CREATION DATE: 05/05/14 PLOT No.: 4083.0184.00 SCALE: NONE	CHECKED: J. WARMAN CHECK DATE: 05/05/14 DWG. NO.: NCS-PFD-1000	APPROVED: P. STOCKBRAND APRR. DATE: 05/05/14 SHEET NO.: 1 OF 2
DWG. NO.	TITLE																																																																																																															
NO.	DESCRIPTION	BY	CHK	DATE	DATE	DATE																																																																																																										
 KAHUNA VENTURES LLC WESTMINSTER, CO 80002 303.451.7374 BY: KAHUNA DESIGN L.L.C.	DRAWN BY: A. COOLEY CREATION DATE: 05/05/14 PLOT No.: 4083.0184.00 SCALE: NONE	CHECKED: J. WARMAN CHECK DATE: 05/05/14 DWG. NO.: NCS-PFD-1000	APPROVED: P. STOCKBRAND APRR. DATE: 05/05/14 SHEET NO.: 1 OF 2																																																																																																													

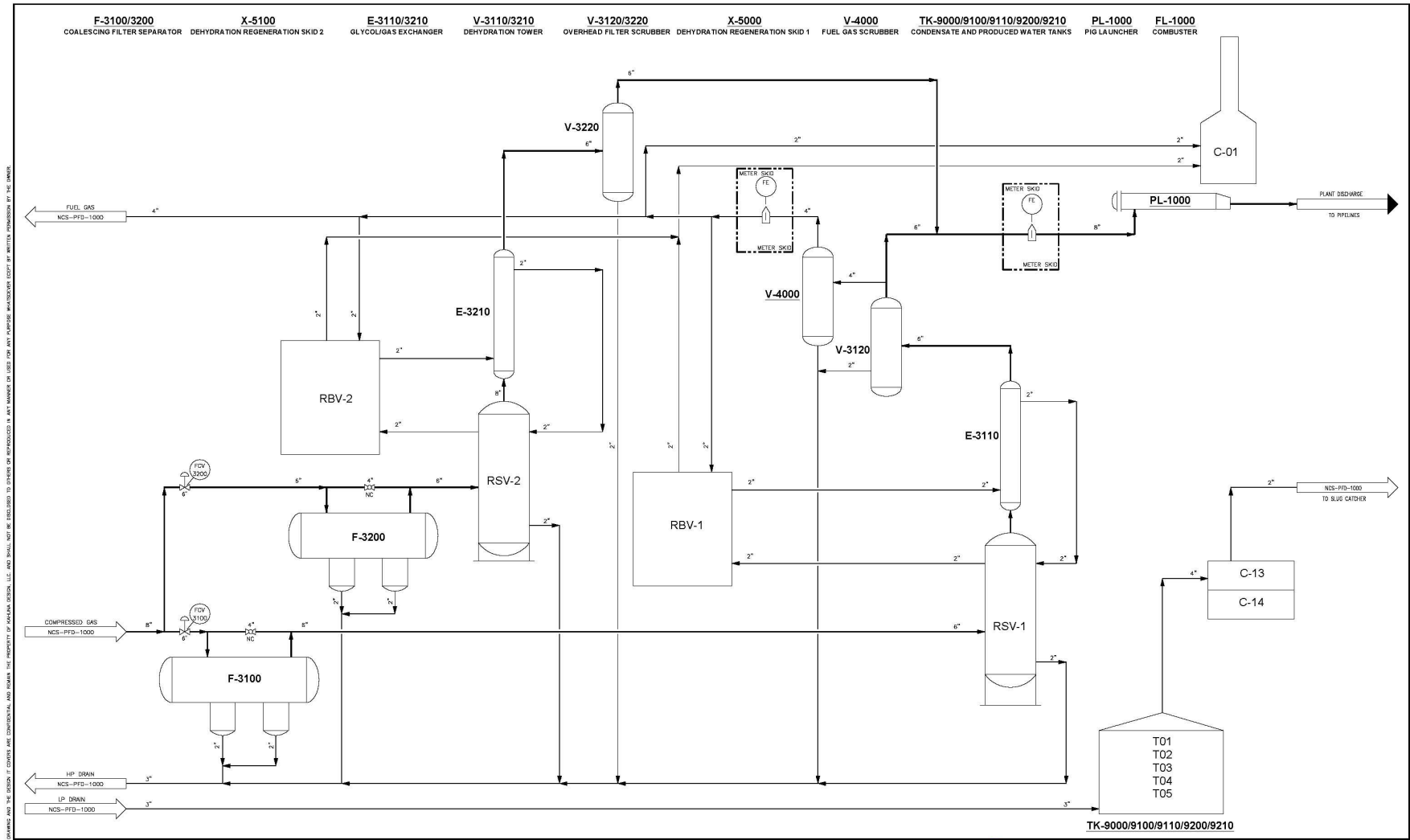

THE DRAWING AND THE DESIGN IT SHOWS ARE CONFIDENTIAL AND REMAIN THE PROPERTY OF ANTERO DESIGN, LLC AND SHALL NOT BE DISCLOSED TO OTHERS OR REPRODUCED IN ANY MANNER OR USED FOR ANY PURPOSE UNLESS EXPRESSLY IN WRITING PERMITTED BY THE OWNER.
 FILE LOCATION: \\PROJECTS\ANTERO\APPALACHIAN RESOURCES\NCS-PFD-1000 - MOBILE CS\1000-PFD-1000-NCS-PFD-1000.DWG

LATE SALES: 05/17/14 BY: Anna Downey
 PLOT TIME/DATE: June 18, 2014

30

NOTES:		REFERENCE DRAWINGS		REVISIONS		 NICHOLS COMPRESSOR STATION		PROCESS FLOW DIAGRAM	
						 KARUNA VENTURES LLC WESTMINSTER, CO 80002 303.451-7374 BY: KARUNA DESIGN LLC.		DRAWN BY: A. COOLEY CREATION DATE: 05/05/14 Pkg. No.: 4083.0164.00 SCALE: NONE	
						CHECKED: J. WARMAN CHECK DATE: 05/05/14 DWG. NO.: NCS-PFD-1001		APPROVED: P. STOCKBRAND APPR. DATE: 05/06/14 SHEET NO.: 2 OF 2	

**Attachment G.
Process Description**

Nichols Compressor Station – Process Description

The Nichols Compressor Station is located in Doddridge County, West Virginia. Gas from surrounding pipelines enters the facility through one (1) receiver and associated slug catcher. From there, the gas is metered and routed through a scrubber and filter separator. Any produced liquids from the scrubber or separator are sent to the 500 barrel settling tank (T03). Gas from the filter separator is sent to one (1) of thirteen (13) 1680 hp Waukesha compressor engines (CE-01 through CE-13). The thirteen (13) compressor engines are controlled with NSCR catalysts and air-fuel ratio controllers (C-02 through C-12, C-15, C-16). Fuel gas for the compressor engines will be treated prior to the engines by a fuel conditioning skid with a 0.5 MMBtu/hr heater (FUEL1) to allow more complete combustion. Produced fluids are routed to the settling tank and gas goes to one of the two (2) TEG dehydrators.

Each TEG dehydrator (RSV-1 and RSV-2) contains a flash gas tank and 1.5 MMBtu/hr reboiler. Each dehydrator has a design rate of 110 MMscf/day. Within the dehydrator unit, vent gas from the flash gas tank is routed to the reboiler (RBV-1 and RBV-2) and used as fuel. In the case where the flash tank gas cannot be used by the reboiler due to excess gas or the reboiler being offline, the gas will be sent to the VRUs (C-13 and C-14) via the storage tanks (T01 – T05) and thus controlled by 98%. Emissions from each reboiler are routed to the atmosphere. The dehydrator still vents (RSV-1 and RSV-2) are controlled by a combustor with at least 98% control efficiency (C-01). Produced fluids from the dehydrator are routed to the settling tank. The dry gas from the dehydration process is either routed to a fuel gas scrubber, metered, and routed to the compressors as fuel gas or metered and sent to plant discharge.

All produced fluids enter one (1) 500 barrel settling tank (T03) where the fluids settle out as either condensate or produced water. The produced water goes to two (2) 400 barrel produced water tanks (T01 and T02) and the condensate goes to two (2) 400 barrel condensate tanks (T04 and T05). Flashing only occurs at the settling tank as the fluids stabilize in the settling tank before going to the other storage tanks. All five (5) tanks are connected to a vapor recovery unit (C-13) where tank vapors are collected and recycled back into the gas system right before the initial filter scrubber. There is a second vapor recovery unit (C-14) that is used as a back-up control for the storage tanks. The produced fluids are trucked out via tanker trucks as needed (EPLOR). The production is 150.9 barrels per day of condensate and 44.7 barrels per day of produced water.

Two (2) natural gas microturbine generators, each rated at 200 kWe supply power to the facility (GEN1 – GEN2). A small 24,000 Btu/hr catalytic heater (CATHT-1) is used to heat the fuel to power the generators. Fugitive emissions from component leaks, traffic on unpaved roads, and emissions from venting or blowdown events also occur.

There will also be nine (9) small storage tanks onsite. A list of the tanks and their capacity is in the table below.

Tag Number	Description	Gallons
TK-9440	Compressor Lube Oil Tank	2,000
TK-9410	Bulk TEG Storage Tank	1,000
TK-9430	Bulk Lube Oil Storage Tank	2,000
TK-9330	Waste Oil Storage Tank	1,000
TK-9420	Bulk Coolant Storage Tank	520
TK-9300	Compressor Skid Oily Water Tank	1,000
TK-9310	Sump Collection Tank	1,000
TK-9320	Jacket Water Storage Tank	1,000
TK-9400	Compressor Waste Oil Tank	4,200

**Attachment H.
Material Safety Data Sheets**



SAFETY DATA SHEET

Material Name: Produced Water

US GHS

SYNONYMS: Produced Brine Water, Brine, Brine Water, Formation Water

***** Section 1 – PRODUCT AND COMPANY IDENTIFICATION *****

PRODUCT NAME:	Produced Water	EMERGENCY PHONE:	(800) 878-1373
PRODUCT CODES:	Mixture	AFTER HOURS:	(800) 878-1373
PRODUCER:	Antero Resources		
ADDRESS:	1615 Wynkoop Street Denver, Colorado 80202	CHEMTREC PHONE:	(800) 424-9300

***** Section 2 – HAZARDS IDENTIFICATION *****

GHS Classification:
Eye Irritant – Category 2A.

GHS LABEL ELEMENTS
Symbol(s)



Signal Word
Warning

Hazard Statements
Causes serious eye irritation

Precautionary Statements
Prevention
Wear protective gloves/protective clothing/eye protection/face protection.

Response
If on SKIN (or hair): Rinse skin with water / shower. Remove / Take off all contaminated clothing immediately.

SAFETY DATA SHEET

Material Name: Produced Water

US GHS

If in EYES: Rinse cautiously with water for at least fifteen (15) minutes. Remove Contact Lenses, if present and easy to do. Continue rinsing.

If EYE irritation persists, get medical advice / attention.

Storage

Store in a secure area.

Disposal

Dispose of contents/containers in accordance with regulations.

***** Section 3 – COMPOSITION / INFORMATION ON INGREDIENTS *****

CAS #	Component	Percent
7732-18-5	Water	80
7647-14-5	Sodium Chloride	20

Because brine water is a natural product, composition can vary greatly.

***** Section 4 – FIRST AID MEASURES *****

First Aid: Eyes

Flush eyes with clean running water for at least fifteen (15) minutes. If irritation or redness develops from exposure, following flushing, seek medical attention.

First Aid: Skin

First aid is not required, normally. However, it is a good practice to wash any chemical from the skin.

First Aid: Ingestion (Swallowing)

First aid is not required, normally. If spontaneous vomiting occurs, lean the victim forward to reduce the risk of aspiration. Monitor for breathing difficulties. If symptoms develop, seek medical attention.

First Aid: Inhalation (Breathing)

Remove person to fresh air. If person is not breathing, provide artificial respiration. If necessary, provide additional oxygen once breathing is restored if trained to do so. Seek medical attention immediately.

SAFETY DATA SHEET

Material Name: Produced Water

US GHS

Most important symptoms and effects

None known or anticipated.

*** Section 5 – FIRE FIGHTING MEASURES ***

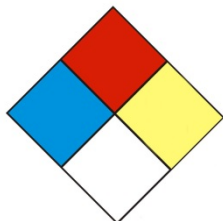

NFPA 704 Hazard Class

Health: 1 Flammability: 0 Instability: 0 (0=Minimal, 1=Slight, 2=Moderate, 3=Serious, 4=Severe)

General Fire Hazards

No fire hazards are expected.

General Fire Hazards

No unusual fire or explosion hazards are expected. If container is not properly cooled, it can rupture in the heat of a fire.

Extinguishing Media

The material is non-flammable. Use extinguishing agent suitable for the type of surrounding fire.

Unsuitable Extinguishing Media

None

Fire Fighting Equipment / Instructions

Small fires in the beginning stage may typically be extinguished using handheld portable fire extinguishers and other firefighting equipment. Isolate area around container involved in fire and keep unauthorized personnel out. Stop spill/release if it can be done safely. Move undamaged containers from the immediate hazard area if it can be done safely. Cool equipment exposed to fire with water, if it can be done safely.

Hazardous Combustion Products

None Anticipated. See Section 9 for Flammable Properties including Flash Point and Flammable (Explosive) Limits

SAFETY DATA SHEET

Material Name: Produced Water

US GHS

*** Section 6 – ACCIDENTAL RELEASE MEASURES ***
--

Recovery and Neutralization

Contain and stop the source of the spill, if safe to do so.

Materials and Methods for Clean-Up

Notify relevant authorities in accordance with all applicable regulations. Immediate cleanup of any spill is recommended. Dike far ahead of spill for later recovery or disposal. Absorb spill with inert material such as sand or vermiculite, and place in suitable container for disposal. If spilled on water remove with appropriate methods (e.g. skimming, booms or absorbents). In case of soil contamination, remove contaminated soil for remediation or disposal, in accordance with local regulations.

Recommended measures are based on the most likely spillage scenarios of this material. However, local conditions and regulations may influence or limit the choice of appropriate actions to be taken. See Section 13 for information on appropriate disposal.

Emergency Measures

The material is not considered hazardous. Nevertheless, evacuate nonessential personnel and secure the area. Stay upwind and uphill, if possible.

Personal Precautions and Protective Equipment

Stay upwind and away from the spill/release. Avoid direct contact with the material. For large spillages, notify persons downstream of the spill/release. Isolate the immediate hazard area and keep unauthorized personnel out. Response and clean-up crews must be properly trained and must utilize proper protective equipment (see Section 8).

Environmental Precautions

Protect bodies of water by diking or absorbents, if possible. Do not flush down sewer or drainage systems. Use water sparingly to minimize environmental contamination and reduce disposal requirements. If a spill occurs on water, notify appropriate authorities and advise shipping of any hazard.

Prevention of Secondary Hazards

None

SAFETY DATA SHEET

Material Name: Produced Water

US GHS

*** Section 7 – HANDLING AND STORAGE ***

Handling Procedures

Wash thoroughly after handling. Use good personal hygiene practices and wear appropriate personal protective equipment (see section 8).

Do not enter confined spaces such as tanks or pits without following proper entry procedures such as ASTM D-4276 and 29 CFR 1910.146. Do not wear contaminated clothing or shoes.

Storage Procedures

Keep container(s) tightly closed and properly labeled. Use and store this material in cool, dry, well ventilated areas. Store only in approved containers. Keep away from any incompatible material (see Section 10). Protect container(s) against physical damage.

Incompatibilities

Keep away from excessive heat to prevent rupture of container.

*** Section 8 – EXPOSURE CONTROLS / PERSONAL PROTECTION ***

Component Exposure Limits

Water (7732-18-5)

ACGIH: Not listed

Sodium Chloride (7647-14-5)

ACGIH: Not listed

Engineering Measures

If current ventilation practices are not adequate to maintain airborne concentrations below the established exposure limits, additional engineering controls may be required.

Personal Protective Equipment: Respiratory

Emergencies or conditions that could result in significant airborne exposures may require the use of NIOSH approved respiratory protection. An industrial hygienist or other appropriate health and safety professional should be consulted for specific guidance under these situations.

A respiratory protection program that meets or is equivalent to OSHA 29 CFR

SAFETY DATA SHEET

Material Name: Produced Water

US GHS

1910.134 and ANSI Z88.2 should be followed whenever workplace conditions warrant a respirator's use.

Personal Protective Equipment: Skin and Hands

The use of skin protection is not normally required; however, good industrial hygiene practice suggests the use of gloves or other appropriate skin protection whenever working with chemicals.

Personal Protective Equipment: Eyes

Safety glasses or goggles that meet or exceed ANSI Z-87.1 are recommended where there is a possibility of splashing or spraying.

Hygiene Measures

Emergency eye wash capability should be available in the near proximity to operations presenting a potential splash exposure. Use good personal hygiene practices. Avoid repeated and/or prolonged skin exposure. Wash hands before eating, drinking, smoking, or using toilet facilities. Promptly remove contaminated clothing and launder before reuse.

*** Section 9 – PHYSICAL AND CHEMICAL PROPERTIES ***

Appearance:	Clear to Brown	Odor:	Salty
Physical State:	Liquid	pH:	ND
Vapor Pressure:	< 0.36 psia @ 70°F / 21.1°C	Vapor Density:	> 1
Boiling Point:	212°F / 100°C	Melting Point:	2.4°F / -16.5°C
Solubility (H2O):	Complete	Specific Gravity:	1.1 @ 68°F / 20°C
Evaporation Rate:	Variable	VOC:	ND
Octanol / H2O Coeff.:	ND	Flash Point:	ND
Flash Point Method:	ND	Upper Flammability Limit:	ND
Lower Flammability Limit: (LFL):	ND	(UFL):	
Auto Ignition:	ND	Burning Rate:	ND

SAFETY DATA SHEET

Material Name: Produced Water

US GHS

*** Section 10 – CHEMICAL STABILITY & REACTIVITY INFORMATION ***

Chemical Stability

This is a stable material.

Hazardous Reaction Potential

Will react with alkali and alkaline metals to form flammable hydrogen gas.

Conditions to Avoid

Avoid contact with alkali metals (lithium, sodium, potassium), alkaline metals (beryllium, magnesium, calcium, strontium, and barium), and metallic hydrides like lithium aluminum hydride.

Hazardous Decomposition Products

Not anticipated under normal conditions of use.

Hazardous Polymerization

Not known to occur.

*** Section 11 – TOXICOLOGICAL INFORMATION ***

Acute Toxicity

A: General Product Information

Unlikely to be harmful.

B. Component Analysis – D50/LC50

Water (7732-18-5)

Oral LD50 Rat 90 g/kg

Sodium Chloride (7647-14-5)

Oral LD50 Rat 3 g/kg

Potential Health Effects: Skin Corrosion Property / Stimulativeness

May cause skin irritation with prolonged or repeated contact. Not expected to be a skin sensitizer.

Potential Health Effects: Eye Critical Damage / Stimulativeness

Contact with eyes may cause moderate irritation.

SAFETY DATA SHEET

Material Name: Produced Water

US GHS

Potential Health Effects: Ingestion

Ingestion may result in nausea, vomiting, diarrhea, abdominal cramps, and dehydration (thirst).

Potential Health Effects: Inhalation

No information available on the mixture. However, none of the components have been classified for respiratory sensitization (or are below the concentration threshold for classification).

Generative Cell Mutagenicity

Not expected to cause genetic effects.

Carcinogenicity

General Product Information

Not expected to cause cancer. This substance is not listed as a carcinogen by IARC, NTP or OSHA.

Reproductive Toxicity

This product is not reported to have any reproductive toxicity effects.

Specified Target Organ General Toxicity: Single Exposure

This product is not reported to have any specific target organ general toxicity single exposure effects.

Specified Target Organ General Toxicity: Repeated Exposure

This product is not reported to have any specific target organ general toxicity multiple exposure effects.

Aspiration Respiratory Organs Hazard

The major health threat of ingestion occurs from the danger of aspiration (breathing) of liquid drops into the lungs, particularly from vomiting. Aspiration may result in chemical pneumonia (fluid in the lungs), severe lung damage, respiratory failure and even death.

*** Section 12 – ECOLOGICAL INFORMATION ***
--

Ecotoxicity

A: General Product Information

Keep out of sewers, drainage areas, and waterways. Report spills and releases, as applicable under Federal and State regulations.

SAFETY DATA SHEET

Material Name: Produced Water

US GHS

Persistence / Degradability

No information available

Bioaccumulation

No information available

Mobility in Soil

No information available

*** Section 13 – DISPOSAL CONSIDERATIONS ***

Waste Disposal Instructions

See Section 7 for Handling Procedures. See Section 8 for Personal Protective Equipment Recommendations.

Disposal of Contaminated Containers or Packaging

Recover or recycle if possible. It is the responsibility of the generator to determine the toxicity and physical properties of the material generated so as to properly classify the waste and ensure disposal methods comply with applicable regulations.

This material, if discarded as produced, is not a RCRA "listed" hazardous waste, and is not believed to exhibit characteristics of hazardous waste. Consult state and local regulations regarding the proper disposal of this material. Do not dispose of brine water by draining onto the ground. This will result in soil and groundwater contamination. Waste arising from spillage or tank cleaning should be disposed of in accordance with applicable regulations.

Container contents should be completely used and containers should be emptied prior to discard. Container rinsate should not be considered a RCRA hazardous waste but must be disposed of with care and in full compliance with federal, state and local regulations. Larger empty containers, such as drums, should be returned to the distributor or to a qualified drum reconditioner. To assure proper disposal of smaller empty containers, consult with state and local regulations and disposal authorities.

*** Section 14 – TRANSPORTATION INFORMATION ***

DOT Information

Shipping Description: Not Regulated

UN #: Not Regulated

SAFETY DATA SHEET

Material Name: Produced Water

US GHS

*** Section 15 – REGULATORY INFORMATION ***

CERCLA/SARA – Section 302 Extremely Hazardous Substances and TPQs (in pounds):

This material does not contain any chemicals subject to the reporting requirements of SARA 302 and 40 CFR 372,

CERCLA/SARA – Section 313 and 40 CFR 372):

This material does not contain any chemicals subject to the reporting requirements of SARA 313 and 40 CFR 372.

EPA (CERCLA) Reportable Quantity (in pounds):

This material does not contain any chemicals with CERCLA Reportable Quantities.

State Regulations

Component Analysis

The following components appear on one or more of the following state hazardous substances list.

California Proposition 65:

This material does not contain any chemicals that are known to the State of California to cause cancer, birth defects or other reproductive harm at concentrations that trigger the warning requirements of California Proposition 65.

National Chemical Inventories:

All components are either listed on the US TSCA Inventory, or are not regulated under TSCA.

U.S. Export control classification Number: EAR99.

*** Section 16 – OTHER INFORMATION ***

NFPA® Hazard Rating

Health 1
Fire 0
Reactivity 0

HMIS® Hazard Rating

Health 1 Slight
Fire 0 Minimal
Physical 0 Minimal

SAFETY DATA SHEET

Material Name: Produced Water

US GHS

Key/Legend

EPA = Environmental Protection Agency; TSCA = Toxic Substance Control Act; ACGIH = American Conference of Governmental Industrial Hygienists; IARC = International Agency for Research on Cancer; NIOSH = National Institute for Occupational Safety and Health; NTP = National Toxicology Program; OSHA = Occupational Safety and Health Administration; NJTSR = New Jersey Trade Secret Registry.

Literature References

None

Other Information

The information presented herein has been compiled from sources considered to be dependable, and is accurate and reliable to the best of our knowledge and belief, but is not guaranteed to be so. Since conditions of use are beyond our control, we make no warranties, expressed or implied, except those that may be contained in our written contract of sale or acknowledgment.

Vendor assumes no responsibility for injury to vendee or third persons proximately caused by the material if reasonable safety procedures are not adhered to as stipulated in the data sheet. Additionally, vendor assumes no responsibility for injury to vendee or third persons proximately caused by abnormal use of the material, even if reasonable safety procedures are followed. Furthermore, vendee assumes the risk in their use of the material.

Date of Preparation: January 28, 2014

Date of Last Revision: March 4, 2014

End of Sheet

Material Name: Natural Gas Condensate

US GHS

SYNONYMS: Drips; Condensate; Field Condensate; Gas Well Condensate; High Pressure Inlet Liquids; Lease Condensate; Natural Gas Liquids; Pipeline Liquids

*** Section 1 – PRODUCT AND COMPANY IDENTIFICATION ***

PRODUCT NAME: Natural Gas Condensate EMERGENCY PHONE: (800) 878-1373

PRODUCT CODES: 64741-47-5 AFTER HOURS: (800) 878-1373

PRODUCER: Antero Resources

ADDRESS: 1615 Wynkoop Street CHEMTREC PHONE: (800) 424-9300

Denver, Colorado 80202

*** Section 2 – HAZARDS IDENTIFICATION ***

GHS Classification:

- Flammable Liquids – Category 2.
- Acute Toxicity Inhalation – Category 3
- Germ Cell Mutagenicity – Category 1B
- Carcinogenicity – Category 1A
- Specific Target Organ Systemic Toxicity (STOT) – Single Exposure Category 3
- Specific Target Organ Systemic Toxicity (STOT) – Repeat Exposure Category 1
- Aspiration Toxicity – Category 1
- Toxic to the Aquatic Environment Acute – Category 3

GHS LABEL ELEMENTS

Symbol(s)



Signal Word

Danger

SAFETY DATA SHEET

Material Name: Natural Gas Condensate

US GHS

Hazard Statements

Highly flammable liquid and vapor.

Toxic if inhaled.

May cause genetic defects.

May cause cancer.

May cause respiratory irritation.

May cause drowsiness or dizziness.

May cause damage to organs (liver, kidneys, blood, nervous system, and skin) through prolonged or repeated exposure.

May be fatal if swallowed and enters airways.

Harmful to aquatic life.

Precautionary Statements

Prevention

Keep away from heat/sparks/open flames/hot surfaces. No smoking.

Keep container tightly closed.

Ground/bond container and receiving equipment.

Use explosion-proof electrical/ventilating/lighting equipment.

Use only non-sparking tools.

Take precautionary measures against static discharge.

Wear protective gloves/protective clothing/eye protection/face protection.

Do not breathe gas/mist/vapors/spray.

Do not handle until all safety precautions have been read and understood.

Wash thoroughly after handling.

Do not eat, drink or smoke when using this product.

Use only outdoors or in a well-ventilated area.

Avoid release to the environment.

Response

If on SKIN (or hair): Wash with plenty of soap and water. Remove / Take off all contaminated clothing immediately. Rinse skin with water/shower.

If INHALED: Remove victim to fresh air and keep comfortable for breathing. Call a poison center/doctor if the victim feels unwell.

If SWALLOWED: Immediately call a poison center or doctor / physician. Do not induce vomiting.

If exposed or concerned: Get medical advice/attention.

In case of fire: Use water spray, fog or fire-fighting foam.

Storage

Store in a well-ventilated place. Keep cool.

Store in a secure area.

SAFETY DATA SHEET

Material Name: Natural Gas Condensate

US GHS

Disposal

Dispose of contents/containers in accordance with local/regional/national/international regulations.

*** Section 3 – COMPOSITION / INFORMATION ON INGREDIENTS ***

CAS #	Component	Percent
111-65-9	Octanes	25 - 95
142-82-5	Heptanes	25 - 95
110-54-3	Hexanes as n-Hexane	25 - 95
109-66-0	Pentanes as n-Pentane	5 - 70
106-97-8	N-butane	0 - 45
74-98-6	Propane	0 - 15
78-84-0	Ethane	0 - 5
71-43-2	Benzene	< 1
108-88-3	Toluene	< 1
1330-20-7	m-,o-,p-Xylene	< 1

Because natural gas condensate is a natural product, composition can vary greatly.

*** Section 4 – FIRST AID MEASURES ***

First Aid: Eyes

Flush eyes with clean running water for at least fifteen (15) minutes. Following flushing, seek medical attention.

First Aid: Skin

Remove contaminated clothing. Wash contaminated areas thoroughly with soap and water or waterless hand cleanser. Obtain medical attention if irritation or redness develops. Wash contaminated clothing before reuse.

First Aid: Ingestion (swallowing)

DO NOT INDUCE VOMITING. Do not give liquids. Obtain immediate medical attention. If spontaneous vomiting occurs, lean the victim forward to reduce the risk of aspiration. Monitor for breathing difficulties. Small amounts of material which enter the mouth should be rinsed out until the taste is dissipated.

SAFETY DATA SHEET

Material Name: Natural Gas Condensate

US GHS

First Aid: Inhalation (breathing)

Remove person to fresh air. If person is not breathing, provide artificial respiration. If necessary, provide additional oxygen once breathing is restored if trained to do so. Seek medical attention immediately.

*** Section 5 – FIRE FIGHTING MEASURES ***

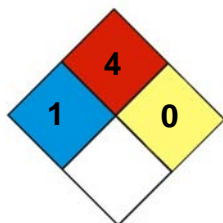

NFPA 704 Hazard Class

Health: 1 Flammability: 4 Instability: 0 (0-Minimal, 1-Slight, 2-Moderate, 3-Serious, 4-Severe)

General Fire Hazards

See Section 9 for Flammability Properties.

Extremely flammable. Vapors may be ignited rapidly when exposed to heat, spark, open flame, or other source of ignition (e.g., static electricity, pilot lights, mechanical / electrical equipment, and electronic devices such as cell phones, computers, calculators, and pagers which have not been certified as intrinsically safe). Flammable vapors can burn in the open or explode in confined spaces. Vapors are heavier than air, and may travel distances to an ignition source and flash back. Runoff to sewer systems may cause fire or explosion.

Hazardous Combustion Products

Carbon monoxide, carbon dioxide and non-combusted hydrocarbons (smoke).

Extinguishing Media

SMALL FIRES: Any extinguisher suitable for Class B fires, dry chemical, firefighting foam, water spray, carbon dioxide (CO₂), or other gaseous extinguishing agents. Use caution when applying CO₂ in confined spaces.

LARGE FIRES: Water spray, fog or fire-fighting foam. Water may be ineffective for fighting the fire, but may be used to cool fire-exposed containers.

Unsuitable Extinguishing Media

None

SAFETY DATA SHEET

Material Name: Natural Gas Condensate

US GHS

Fire Fighting Equipment / Instructions

Small fires in the beginning stage may typically be extinguished using handheld portable fire extinguishers and other firefighting equipment. Isolate area around container involved in fire. Cool tanks, shells, and containers exposed to fire and excessive heat with water. For massive fires the use of unmanned hose holders or monitor nozzles may be advantageous to minimize personnel exposure. Major fires may require withdrawal, allowing the tank to burn. Large storage tank fires typically require specially trained personnel and equipment to extinguish the fire, often including the need for properly applied firefighting foam.

Firefighting activities that may result in potential exposure to high heat, smoke or toxic by-products of combustion should require NIOSH/MSHA- approved pressure-demand self-contained breathing apparatus with full face piece and full protective clothing.

* * * Section 6 – ACCIDENTAL RELEASE MEASURES * * *

Recovery and Neutralization

Contain and stop the source of the spill, if safe to do so.

Materials and Methods for Clean-Up

Notify relevant authorities in accordance with all applicable regulations. Immediate cleanup of any spill is recommended. Dike far ahead of spill for later recovery or disposal. Absorb spill with inert material such as sand or vermiculite, and place in suitable container for disposal. If spilled on water remove with appropriate methods (e.g. skimming, booms or absorbents). In case of soil contamination, remove contaminated soil for remediation or disposal, in accordance with local regulations.

Recommended measures are based on the most likely spillage scenarios for this material; however local conditions and regulations may influence or limit the choice of appropriate actions to be taken.

Emergency Measures

Evacuate nonessential personnel and secure all ignition sources. No road flares, smoking or flames in hazard area. Consider wind direction. Stay upwind and uphill, if possible. Vapor cloud may be white, but color will dissipate as cloud disperses. Fire and explosion hazard is still present.

Personal Precautions and Protective Equipment

Response and clean-up crews must be properly trained and must utilize proper protective equipment (see Section 8). Extremely flammable. Spillages of liquid product will create a fire hazard and may form an explosive atmosphere. Keep all sources of

SAFETY DATA SHEET

Material Name: Natural Gas Condensate

US GHS

ignition and hot metal surfaces away from spill/release if safe to do so.

The use of explosion-proof electrical equipment is recommended. Stay upwind and away from spill/release. Avoid direct contact with material. For large spillages, notify persons downwind of the spill/release, isolate immediate hazard area and keep unauthorized personnel out. Wear appropriate protective equipment, including respiratory protection, as conditions warrant (see Section 8). See Sections 2 and 7 for additional information on hazards and precautionary measures.

Environmental Precautions

Protect bodies of water by diking, absorbents, or absorbent boom, if possible. Do not flush down sewer or drainage systems, unless system is designed and permitted to handle such material. The use of firefighting foam may be useful in certain situations to reduce vapors. If spill occurs on water notify appropriate authorities and advise shipping of any hazard. Spills into or upon navigable waters, the contiguous zone, or adjoining shorelines that cause a sheen or discoloration on the surface of the water, may require notification of the National Response Center (phone number 800-424-8802).

Prevention of Secondary Hazards

None

*** Section 7 – HANDLING AND STORAGE ***

Handling Procedures

Keep away from flame, sparks and excessive temperatures. Bond and ground containers. Use non-sparking tools. Use only outdoors or in well ventilated areas. Wear protective gloves / clothing and eye / face protection. Wash thoroughly after handling. Use good personal hygiene practices and wear appropriate personal protective equipment (see section 8).

Storage Procedures

Store only in approved containers. Bond and ground containers. Keep away from flame, sparks, excessive temperatures and open flames. Keep containers closed and clearly labeled. Empty product containers or vessels may contain explosive vapors. Do not pressurize, cut, heat, weld or expose containers to sources of ignition.

Store in a well-ventilated area. This storage area should comply with NFPA 30 "Flammable and Combustible Liquid Code". Avoid storage near incompatible materials. The cleaning of tanks previously containing this product should follow API Recommended Practice (RP) 2013 "Cleaning Mobile Tanks In Flammable and Combustible Liquid Service" and API RP 2015 "Cleaning Petroleum Storage Tanks."

SAFETY DATA SHEET

Material Name: Natural Gas Condensate

US GHS

Incompatibilities

Keep away from strong oxidizers, ignition sources and heat.

*** Section 8 – EXPOSURE CONTROLS / PERSONAL PROTECTION ***

Component Exposure Limits

Octanes (111-65-9)

ACGIH: 300 ppm TWA (listed under Octane, all isomers)

Heptanes (142-82-5)

ACGIH: 400 ppm TWA (listed under n-Heptane)

n-Hexane (110-54-3)

ACGIH: 20 ppm TWA (listed under n-Hexane)

n-Pentane (109-66-0)

ACGIH: 600 ppm TWA (listed under Pentane, all isomers)

n-Butane (106-97-8)

ACGIH: 600 ppm TWA (listed under n-Butane)

Propane (74-98-6)

ACGIH: 1000 ppm TWA (listed under Aliphatic hydrocarbon gases C1-C4)

Ethane (74-84-0)

ACGIH: 1000 ppm TWA (listed under Aliphatic hydrocarbon gases C1-C4)

Benzene (71-43-2)

ACGIH: 0.5 ppm (TWA); NIOSH: 0.1 ppm (TWA); OSHA 1 ppm (TWA)

Toluene (108-88-3)

ACGIH: 20 ppm TWA (listed under Toluene)

m-, o-, p-Xylene (1330-20-7)

ACGIH: 100 ppm TWA (listed under Xylene o, m & p isomers)

SAFETY DATA SHEET

Material Name: Natural Gas Condensate

US GHS

Engineering Measures

Use adequate ventilation to keep vapor concentrations of this product below occupational exposure and flammability limits, particularly in confined spaces. Use explosion-proof equipment and lighting in classified / controlled areas.

Personal Protective Equipment: Respiratory

Use a NIOSH-approved positive-pressure, supplied air respirator with escape bottle or self-contained breathing apparatus (SCBA) for gas concentrations above occupational exposure limits, for potential for uncontrolled release, if exposure levels are not known, or in an oxygen-deficient atmosphere (oxygen content less than 19.5 percent). A respiratory program that meets or is equivalent to OSHA 29 CFR 1910.134 and ANSI Z88.2 should be followed whenever workplace conditions warrant the use of a respirator.

If benzene concentrations equal or exceed applicable exposure limits, OSHA requirements for personal protective equipment, exposure monitoring, and training may apply (29 CFR 1910.1028 – Benzene).

CAUTION: Flammability limits (i.e., explosion hazard should be considered when assessing the need to expose personnel to concentrations requiring respiratory protection.

Personal Protective Equipment: Hands

Gloves constructed of nitrile or neoprene are recommended.

Personal Protective Equipment: Eyes

Safety glasses or goggles are recommended where there is a possibility of splashing or spraying. Eye protection that meets or exceeds ANSI Z.87.1 is recommended. Depending on conditions of use, a face shield may be necessary.

Personal Protective Equipment: Skin and Body

Chemical protective clothing such as of E.I. DuPont TyChem®, Saranex® or equivalent recommended based on degree of exposure. Note: The resistance of specific material may vary from product to product as well as with degree of exposure. Consult manufacturer specifications for further information.

Hygiene Measures

Emergency eye wash capability should be available in the near proximity to operations presenting a potential splash exposure. Use good personal hygiene practices. Avoid repeated and/or prolonged skin exposure. Wash hands before eating, drinking, smoking, or using toilet facilities. Do not use as a cleaning solvent on the skin. Do not use gasoline or solvents (naphtha, kerosene, etc.) for washing this product from

SAFETY DATA SHEET

Material Name: Natural Gas Condensate

US GHS

exposed skin areas. Waterless hand cleaners are effective. Promptly remove contaminated clothing and launder before reuse. Use care when laundering to prevent the formation of flammable vapors which could ignite via washer or dryer. Consider the need to discard contaminated leather shoes and gloves.

*** Section 9 – PHYSICAL AND CHEMICAL PROPERTIES ***

Appearance:	Colorless to straw yellow	Odor:	Aromatic, Gasoline;
Physical State:	Liquid	pH:	ND
Vapor Pressure:	110 – 200 psia (Reid VP) @ 100°F/37.8°C	Vapor Density (air = 1):	> 1
Boiling Point:	Approx. 85 - 437°F (39 – 200°C)	Melting Point:	ND
Solubility (H2O):	Insoluble to slightly soluble	Specific Gravity:	AP 0.62-0.76 (varies)
Evaporation Rate:	High	VOC:	ND
Octanol / H2O Coeff.:	ND	Flash Point:	-40°F -40°C
Flash Point Method:	Tag Closed Cup (TCC)		
Lower Flammability Limit: (LFL):	ND (NFPA Gasoline 1.4)	Upper Flammability Limit: (UFL):	ND (NFPA Gasoline 7.6)
Auto Ignition:	AP 480°F (250°C)	Burning Rate:	ND

*** Section 10 – CHEMICAL STABILITY & REACTIVITY INFORMATION ***

Chemical Stability

This is a stable material.

Hazardous Reaction Potential

Will not occur.

Conditions to Avoid

Keep away from ignition sources and high temperatures.

Hazardous Decomposition Products

Carbon monoxide, carbon dioxide and non-combusted hydrocarbons (smoke).

SAFETY DATA SHEET

Material Name: Natural Gas Condensate

US GHS

*** Section 11 – TOXICOLOGICAL INFORMATION ***
--

Acute Toxicity

A: General Product Information

Harmful if swallowed.

B. Component Analysis – LD50/LC50

Octanes (111-65-9)

Inhalation LC50 rat = 118,000 mg/m³ / 4H

Heptanes (142-82-5)

Inhalation LC50 rat = 103,000 mg/m³ / 4H

Hexanes as n-Hexane (110-53-3)

Inhalation LC50 rat = 48,000 ppm / 4H

Pentanes as n-Pentane (109-66-0)

Inhalation LC50 rat = 364,000 mg/m³ / 4H

Butanes as n-Butane (106-97-8)

Inhalation LC50 rat 658,000 mg/l / 4H

Propane (74-98-6)

Inhalation LC50 Rat > 800,000 ppm / 0.25H

Ethane (74-84-0)

Inhalation LC50 Rat 658,000 mg/l / 4H

Benzene (71-43-2)

Inhalation LC50 Rat 44,700 mg/m³ /

Toluene (108-88-3)

Inhalation LD50 Rat 12/5 mg/l / 4H

m-, o-, p-Xylene (1330-20-7)

Inhalation LC50 Rat 5000 ppm / 4H

Potential Health Effects: Skin Corrosion Property / Stimulativeness

May cause skin irritation with prolonged or repeated contact. Liquid may be absorbed through the skin in toxic amounts if large areas of skin are exposed repeatedly.

SAFETY DATA SHEET

Material Name: Natural Gas Condensate

US GHS

Potential Health Effects: Eye Critical Damage / Stimulativeness

Contact with eyes may cause moderate irritation.

Potential Health Effects: Ingestion (swallowing)

Ingestion may cause gastrointestinal disturbances, including irritation, nausea, vomiting and diarrhea, and central nervous system (brain) effects similar to alcohol intoxication. In severe cases, tremors, convulsions, loss of consciousness, coma, respiratory arrest, and death may occur.

Potential Health Effects: Inhalation (breathing)

Excessive exposure may cause irritations to the nose, throat, lungs and respiratory tract. Central nervous system (brain) effects may include headache, dizziness, loss of balance and coordination, unconsciousness, coma, respiratory failure, and death.

Respiratory Organs Sensitization / Skin Sensitization

This product is not reported to have any skin sensitization effects.

Generative Cell Mutagenicity

May cause genetic defects. Some crude oils and crude oil fractions have been positive in mutagenicity studies.

Carcinogenicity

A: General Product Information

May cause cancer.

This product contains benzene, although at very low concentrations. Human health studies indicate that prolonged and/or repeated overexposure to benzene may cause damage to the blood-forming system (particularly bone marrow), and serious blood disorders such as aplastic anemia and leukemia. Benzene is listed as a human carcinogen by the NTP, IARC, OSHA and ACGIH.

Exposure to light hydrocarbons in the same boiling range as this product have been associated in animal studies with effects to the central nervous system, peripheral nervous system, liver, and kidneys. The significance of these animal models to predict similar human response is uncertain. Observing good work practices and personal hygiene procedures (Sections 7 and 8) can minimize potential risks to humans.

B: Component Carcinogenicity

Benzene (71-43-2)

ACGIH:	A1 - Confirmed Human Carcinogen
OSHA:	5 ppm STEL (Cancer hazard, Flammable, See 29 CFR 1910.1028, 15 min); 0.5 ppm Action Level; 1 ppm TWA
NIOSH:	potential occupational carcinogen
NTP:	Known Human Carcinogen (Select Carcinogen)

SAFETY DATA SHEET

Material Name: Natural Gas Condensate

US GHS

IARC: Monograph 100F [in preparation]; Supplement 7 [1987]; Monograph 29 [1982] (Group 1 (carcinogenic to humans))

Reproductive Toxicity

This product is not reported to have any reproductive toxicity effects.

Specified Target Organ General Toxicity: Single Exposure

This product is not reported to have any specific target organ general toxicity single exposure effects.

Specified Target Organ General Toxicity: Repeated Exposure

May cause damage to organs (liver, kidneys, blood, nervous system and skin) through prolonged or repeated exposure.

Aspiration Respiratory Organs Hazard

The major health threat of ingestion occurs from the danger of aspiration (breathing) of liquid drops into the lungs, particularly from vomiting. Aspiration may result in chemical pneumonia (fluid in the lungs), severe lung damage, respiratory failure and even death.

*** Section 12 – ECOLOGICAL INFORMATION ***

Ecotoxicity

A: General Product Information

Keep out of sewers, drainage areas, and waterways. Report spills and releases, as applicable under Federal and State regulations.

B: Component Analysis – Ecotoxicity – Aquatic Toxicity

Benzene (71-43-2)

Test and Species	Conditions
96 Hr LC50 Pimephales promelas	10.7-14.7 mg/L [flow-through]
96 Hr LC50 Oncorhynchus mykiss	5.3 mg/L [flow-through]
96 Hr LC50 Lepomis macrochirus	22.49 mg/L [static]
96 Hr LC50 Poecilia reticulata	28.6 mg/L [static]
96 Hr LC50 Pimephales promelas	22330-41160 µg/L [static]
96 Hr LC50 Lepomis macrochirus	70000-142000 µg/L [static]
72 Hr EC50 Pseudokirchneriella subcapitata	29 mg/L
48 Hr EC50 Daphnia magna	8.76 - 15.6 mg/L [static]
48 Hr EC50 Daphnia magna	10 mg/L

SAFETY DATA SHEET

Material Name: Natural Gas Condensate

US GHS

Natural Gas condensates (68919-39-1)

Test and Species	Conditions
96 Hr LC50 Alburnus alburnus	119 mg/L [static]
96 Hr LC50 Cyprinodon variegatus	82 mg/L [static]
72 Hr EC50 Pseudokirchneriella subcapitata	56 mg/L
24 Hr EC50 Daphnia magna	170 mg/L

Persistence / Degradability

No information available

Bioaccumulation

No information available

Mobility in Soil

No information available

*** Section 13 – DISPOSAL CONSIDERATIONS ***

Waste Disposal Instructions

See Section 7 for Handling Procedures. See Section 8 for Personal Protective Equipment Recommendations.

Disposal of Contaminated Containers or Packaging

Recover or recycle if possible. It is the responsibility of the generator to determine the toxicity and physical properties of the material generated so as to properly classify the waste and ensure disposal methods comply with applicable regulations.

This material, if discarded should be fully characterized for ignitability (D001), reactivity (D003) and benzene (D018) prior to disposal (40 CFR261). Use which results in chemical or physical change or contamination may subject it to regulation as a hazardous waste. Along with properly characterizing all waste materials, consult state and local regulations regarding the proper disposal of this material. Do not dispose of by draining onto the ground. This will result in soil and groundwater contamination. Waste arising from spillage or tank cleaning should be disposed of in accordance with applicable regulations.

Container contents should be completely used and containers should be emptied prior to discard. Container rinsate could be considered a RCRA hazardous waste and must be disposed of with care and in full compliance with federal, state and local regulations. Larger empty containers, such as drums, should be returned to the distributor or to a qualified drum reconditioner. To assure proper disposal of smaller empty containers, consult with state and local regulations and disposal authorities.

SAFETY DATA SHEET

Material Name: Natural Gas Condensate

US GHS

*** Section 14 – TRANSPORTATION INFORMATION ***

DOT Information

Shipping Name: Petroleum Products, n.o.s. (condensate)

UN #: 1268 **Hazard Class:** 3

Additional Info.: Dependent on the product's properties, the shipper may also elect to classify as Gasoline UN1203 or Petroleum Crude Oil UN1267 - reference 49 CFR 172.101 for further description (e.g., packing group determination).

Placard:



*** Section 15 – REGULATORY INFORMATION ***

Regulatory Information

Component Analysis

This material contains one or more of the following chemicals required to be identified under SARA Section 302 (40 CFR 355 Appendix A), SARA Section 313 (40 CFR 372.65) and/or CERCLA (40 CFR 302.4).

Benzene (71-43-2)

SARA 313: 0.1% de minimis concentration

CERCLA: 10 lb final RQ (received an adjusted RQ of 10 lbs based on potential carcinogenicity in an August 14, 1989 final rule); 4.54 kg final RQ (received an adjusted RQ of 10 lbs based on potential carcinogenicity in an August 14, 1989 final rule)

SARA Section 311/312 – Hazard Classes

<u>Acute Health</u>	<u>Chronic Health</u>	<u>Fire</u>	<u>Sudden Release of Pressure</u>	<u>Reactive</u>
X	X	X	--	--

SARA SECTION 313 – SUPPLIER NOTIFICATION

This product contains the following toxic chemicals subject to the reporting requirements of section 313 of the Emergency Planning and Community Right-To-Know Act (EPCRA) of 1986 and of 40 CFR 372:

SAFETY DATA SHEET

Material Name: Natural Gas Condensate

US GHS

INGREDIENT NAME (CAS NUMBER)	CONCENTRATION PERCENT BY WEIGHT
Benzene (71-43-2)	<0.1 to 2

Canadian Regulatory Information

DSL/NDSL Inventory	This product has been classified in accordance with the hazard criteria of the Controlled Products Regulations (CPR) and the SDS contains all the information required by the Regulations.
Workplace Hazardous Materials Information System	B2 - Flammable Liquid D1A – Material Causing Immediate and Serious Toxic Effects - Very Toxic Material D2A: Material Causing Other Toxic Effects Very Toxic D2B - Material Causing Other Toxic Effects - Toxic Material

European Union Regulatory Information

Labeling	Product is dangerous as defined by the European Union Dangerous Substances / Preparations Directives. Contains: Low Boiling Point Naphtha
Symbol	F+ Extremely Flammable T Toxic N Dangerous for the Environment
Risk Phrases	R12-45-38-65-67-51/53 Extremely flammable. May cause cancer. Irritating to skin. Harmful: may cause lung damage if swallowed. Vapors may cause drowsiness and dizziness. Toxic to aquatic organisms, may cause long-term adverse effects in the aquatic environment.
Safety Phrases	S16-53-45-2-23-24-29-43-62 Keep away from sources of ignition – No smoking. Avoid exposure – obtain special instructions before use. In case of accident or if you feel unwell, seek medical advice immediately (show the label where possible). Keep out of reach of children. Do not breathe vapor. Avoid contact with skin. Do not empty into drains. In case of fire use foam/dry powder/CO2. If swallowed, do not induce vomiting: seek medical advice immediately and show this container or label.

SAFETY DATA SHEET

Material Name: Natural Gas Condensate

US GHS

State Regulations

Component Analysis – State

The following components appear on one or more of the following state hazardous substances lists

Component	CAS	CA	MA	MN	NJ	PA	RI
Octanes	111-65-9	Yes	No	Yes	Yes	Yes	Yes
Heptanes	142-82-5	Yes	No	Yes	Yes	Yes	Yes
n-Hexane	110-54-3	Yes	Yes	Yes	Yes	Yes	Yes
n-Pentane	109-66-0	Yes	No	Yes	Yes	Yes	Yes
n-Butane	106-97-8	Yes	No	Yes	Yes	Yes	Yes
Propane	74-98-6	No	No	Yes	Yes	Yes	Yes
Ethane	78-84-0	No	No	Yes	Yes	Yes	No
Benzene	71-43-2	Yes	Yes	Yes	Yes	Yes	Yes
Toluene	108-88-3	Yes	Yes	Yes	Yes	Yes	Yes
m-, o-, p-Xylene	1330-20-7	Yes	Yes	Yes	Yes	Yes	Yes

The following statement(s) are provided under the California Safe Drinking Water and Toxic Enforcement Act of 1986 (Proposition 65):

WARNING! This product contains a chemical known to the state of California to cause cancer.

WARNING! This product contains a chemical known to the state of California to cause Reproductive / developmental effects.

Component Analysis – WHMIS IDL

The following components are identified under the Canadian Hazardous Products Act

Ingredient Disclosure List:

Component	CAS #	Minimum Concentration
Benzene	71-43-2	0.1%

* * * Section 16 – OTHER INFORMATION * * *

NFPA® Hazard Rating

Health 1
Fire 4
Reactivity 0

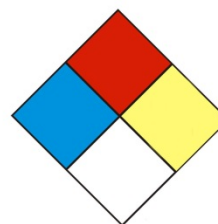

HMIS® Hazard Rating

Health 1 Slight
Fire 4 Severe
Physical 0 Minimal
* Chronic

SAFETY DATA SHEET

Material Name: Natural Gas Condensate

US GHS

Key/Legend

EPA = Environmental Protection Agency; TSCA = Toxic Substance Control Act; ACGIH = American Conference of Governmental Industrial Hygienists; IARC = International Agency for Research on Cancer; NIOSH = National Institute for Occupational Safety and Health; NTP = National Toxicology Program; OSHA = Occupational Safety and Health Administration; NJTSR = New Jersey Trade Secret Registry.

Literature References

None

Other Information

The information presented herein has been compiled from sources considered to be dependable, and is accurate and reliable to the best of our knowledge and belief, but is not guaranteed to be so. Since conditions of use are beyond our control, we make no warranties, expressed or implied, except those that may be contained in our written contract of sale or acknowledgment.

Vendor assumes no responsibility for injury to vendee or third persons proximately caused by the material if reasonable safety procedures are not adhered to as stipulated in the data sheet. Additionally, vendor assumes no responsibility for injury to vendee or third persons proximately caused by abnormal use of the material, even if reasonable safety procedures are followed. Furthermore, vendee assumes the risk in their use of the material.

Date of Preparation: January 29, 2014

Date of Last Revision: March 4, 2014

End of Sheet

Material Name: Wet Field Natural Gas

SYNONYMS: CNG, Natural Gas, Methane.

***** Section 1 – PRODUCT AND COMPANY IDENTIFICATION *****

PRODUCT NAME: Wet Field Natural Gas **EMERGENCY PHONE:** (800) 878-1373

PRODUCT CODES: CAS Reg. No. 68410-63-9 **AFTER HOURS:** (800) 878-1373

PRODUCER: Antero Resources

ADDRESS: 1615 Wynkoop Street **CHEMTREC PHONE:** (800) 424-9300
Denver, Colorado 80202

***** Section 2 – HAZARDS IDENTIFICATION *****

GHS Classification:

Flammable Gas – Category 1.

Gases Under Pressure – Gas.

Specific Target Organ Systemic Toxicity (STOT) – Single Exposure Category 2.

GHS LABEL ELEMENTS

Symbol(s)



Signal Word

Danger

Hazard Statements

Extremely flammable gas.

Contains gas under pressure, may explode if heated.

May cause damage to central nervous and respiratory systems.

Precautionary Statements

Prevention

Keep away from heat/sparks/open flames/hot surfaces. No smoking.

Do not breathe fume/gas/mist/vapors/spray.

Wash thoroughly after handling.

Do not eat, drink or smoke when using this product.

SAFETY DATA SHEET

Material Name: Wet Field Natural Gas

Response

Leaking gas fire: Do not extinguish, unless leak can be stopped safely. Eliminate all ignition sources if safe to do so.

If exposed to gas, or concerned about possible exposure: Call a POISON CENTER or doctor/physician.

Storage

Protect from sunlight. Store in a well-ventilated place.

Store in a secure area.

Disposal

Dispose of contents/containers in accordance with local/regional/national/international regulations.

*** Section 3 – COMPOSITION / INFORMATION ON INGREDIENTS ***

CAS #	Component	Percent
74-82-8	Methane	72 - 97
78-84-0	Ethane	2.2 - 14
74-98-6	Propane	0.0 – 8.0
106-97-8	Butanes	0.0 – 3.5
109-66-0	Pentanes	0.0 – 1.4
110-54-3	Hexanes	0.0 – 0.5
7727-37-9	Nitrogen	< 0.4
124-38-9	Carbon Dioxide	< 0.2
7782-44-7	Oxygen	< 0.04

Because natural gas is a natural product, composition can vary greatly.

*** Section 4 – FIRST AID MEASURES ***

First Aid: Eyes

In case of freeze burn, cover eyes to protect from light. Flush eyes with running water for at least fifteen (15) minutes. Following flushing, seek medical attention.

First Aid: Skin

Remove contaminated clothing. In case of blistering, frostbite or freeze burns, seek immediate medical attention.

SAFETY DATA SHEET

Material Name: Wet Field Natural Gas

First Aid: Ingestion

Risk of ingestion is extremely low. However, if oral exposure occurs, seek immediate medical assistance.

First Aid: Inhalation

Remove person to fresh air. If person is not breathing, provide artificial respiration. If necessary, provide additional oxygen once breathing is restored if trained to do so. Seek medical attention immediately.

***** Section 5 – FIRE FIGHTING MEASURES *****

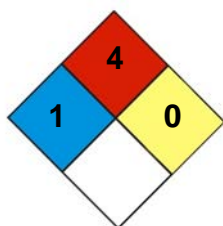

NFPA 704 Hazard Class

Health: **1** Flammability: **4** Instability: **0** (0-Minimal, 1-Slight, 2-Moderate, 3-Serious, 4-Severe)

General Fire Hazards

See Section 9 for Flammability Properties.

Forms a flammable mixture with air. If released, the resulting vapors will disperse with the prevailing wind. If a source of ignition is present where the vapor exists at a 5 – 15% concentration in air, the vapor will burn along the flame front toward the source of the fuel.

Hazardous Combustion Products

Carbon monoxide, carbon dioxide and non-combusted hydrocarbons (smoke).

Extinguishing Media

Any extinguisher suitable for Class B fires, dry chemical, firefighting foam, CO₂, and other gaseous agents. However, fire should not be extinguished unless flow of gas can be immediately stopped.

Unsuitable Extinguishing Media

None.

Fire Fighting Equipment / Instructions

Gas fires should not be extinguished unless flow of gas can be immediately stopped. Shut off gas source and allow gas to burn out. If spill or leak has not ignited, determine

SAFETY DATA SHEET

Material Name: Wet Field Natural Gas

if water spray may assist in dispersing gas or vapor to protect personnel attempting to stop leak. Use water to cool equipment, surfaces and piping exposed to fire and excessive heat. For large fire, the use of unmanned hose holders or monitor nozzles may be advantageous to further minimize personnel exposure. Isolate area, particularly around piping. Let the fire burn unless leak can be stopped. Concentrate fire-fighting efforts on objects / materials ignited by the initial fire. Withdraw immediately in the event of a rising sound from a venting safety device.

Firefighting activities that may result in potential exposure to high heat, smoke or toxic by-products of combustion should require NIOSH-approved pressure-demand self-contained breathing apparatus with full facepiece and full protective clothing.

*** Section 6 – ACCIDENTAL RELEASE MEASURES ***
--

Recovery and Neutralization

Stop the source of the release, if safe to do so.

Materials and Methods for Clean-Up

Consider the use of water spray to disperse gas vapors. Do not use water spray to direct gas vapors toward sewer or drainage systems. Isolate the area until gas has dispersed. Ventilate and gas test area before entering.

Emergency Measures

Evacuate nonessential personnel and secure all ignition sources. No road flares, smoking or flames in hazard area. Consider wind direction. Stay upwind and uphill, if possible. Vapor cloud may be white, but color will dissipate as cloud disperses. Fire and explosion hazard is still present.

Personal Precautions and Protective Equipment

Cooling effect of expanding gas from leak may present frostbite / freeze burn hazard. Wear flame retardant (FR) clothing around un-ignited leak. Wear fire protective clothing around an active fire.

Environmental Precautions

Do not flush gas vapors toward sewer or drainage systems.

Prevention of Secondary Hazards

None.

SAFETY DATA SHEET

Material Name: Wet Field Natural Gas

*** Section 7 – HANDLING AND STORAGE ***

Handling Procedures

Keep away from flame, sparks and excessive temperatures. Bond and ground containers. Use only in well ventilated areas.

Storage Procedures

Natural gas will be contained in the pipeline. Keep away from flame, sparks, excessive temperatures and open flames. Empty pipeline segments may contain explosive residues from natural gas liquids. Do not cut, heat, weld or expose containers to sources of ignition sections of pipeline unless the sections have been purged of natural gas residues.

Incompatibilities

Keep away from strong oxidizers, ignition sources and heat.

*** Section 8 – EXPOSURE CONTROLS / PERSONAL PROTECTION ***

Component Exposure Limits

Methane (74-82-8)

ACGIH: 1000 ppm TWA (listed under Aliphatic hydrocarbon gases : Alkane C1-4)

Ethane (74-84-0)

ACGIH: 1000 ppm TWA (listed under Aliphatic hydrocarbon gases : Alkane C1-4)

Propane (74-98-6)

ACGIH: 2500 ppm TWA (listed under Aliphatic hydrocarbon gases : Alkane C1-4)

Butane (106-97-8)

ACGIH: 800 ppm TWA (listed under Aliphatic hydrocarbon gases : Alkane C1-4)

Pentanes (109-66-0)

ACGIH: 600 ppm TWA (listed under Pentane, all isomers)

Hexanes (110-54-3)

ACGIH: 50 ppm TWA (listed under n-Hexane)

SAFETY DATA SHEET

Material Name: Wet Field Natural Gas

Nitrogen (7727-37-9)

Simple Asphyxiant

Carbon Dioxide (124-38-9)

ACGIH: 5000 ppm TWA (listed under Carbon Dioxide)

Oxygen (7782-44-7)

N/A – Necessary for life

Engineering Measures

Use adequate ventilation to keep gas and vapor concentrations of this product below occupational exposure and flammability limits, particularly in confined spaces. Use explosion-proof equipment and lighting in classified / controlled areas.

Personal Protective Equipment: Respiratory

Use a NIOSH approved positive-pressure, supplied air respirator with escape bottle or self-contained breathing apparatus (SCBA) for gas concentrations above occupational exposure limits, for potential for uncontrolled release, if exposure levels are not known, or in an oxygen-deficient atmosphere. CAUTION: Flammability limits (i.e., explosion hazard should be considered when assessing the need to expose personnel to concentrations requiring respiratory protection.

Personal Protective Equipment: Hands

Use cold-impervious, insulating flame-retardant (FR) gloves where contact with pressurized gas may occur.

Personal Protective Equipment: Eyes

Where there is a possibility of pressurized gas contact, wear splash-proof safety goggles and faceshield.

Personal Protective Equipment: Skin and Body

Where contact with pressurized gas may occur, wear flame-retardant (FR) and a faceshield.

***** Section 9 – PHYSICAL AND CHEMICAL PROPERTIES *****

Appearance: Colorless	Odor: Odorless to slight petroleum odor
Physical State: Gas	pH: ND
Vapor Pressure: 40 atm @ -187°F (-86°C)	Vapor Density: 0.6
Boiling Point: -259°F (-162°C)	Melting Point: ND
Solubility (H2O): 3.5%	Specific Gravity: 0.4 @ -263°F (-164°C)

SAFETY DATA SHEET

Material Name: Wet Field Natural Gas

Evaporation Rate: ND	VOC: ND
Octanol / H₂O Coeff.: ND	Flash Point: Flammable Gas
Flash Point Method: N/A	
Lower Flammability Limit: 3.8 – 6.5	Upper Flammability Limit: 13-17
(LFL):	(UFL):
Auto Ignition: 900-1170°F (482-632°C)	Burning Rate: ND

*** Section 10 – CHEMICAL STABILITY & REACTIVITY INFORMATION ***

Chemical Stability

This is a stable material.

Hazardous Reaction Potential

Will not occur.

Conditions to Avoid

Keep away from strong oxidizers, ignition sources and heat.

Hazardous Decomposition Products

Carbon monoxide, carbon dioxide and non-combusted hydrocarbons (smoke).

*** Section 11 – TOXICOLOGICAL INFORMATION ***

Acute Toxicity

A: General Product Information

Methane and ethane, the main components of natural gas, are considered practically inert in terms of physiological effects. At high concentrations these materials act as simple asphyxiants and may cause death due to lack of oxygen.

B. Component Analysis – LD50/LC50

Methane (74-82-8)

Inhalation LC50 Mouse 326 g/m³ 2h

Ethane (74-84-0)

Inhalation LC50 Rat 658 mg/l 4h

Propane (74-98-6)

Inhalation LC50 Rat 658 mg/l 4h

SAFETY DATA SHEET

Material Name: Wet Field Natural Gas

Butanes (106-97-8)

Inhalation LC50 Rat 658 g/m³ 4h

Pentanes (109-66-0)

Inhalation LD50 Rat 364 g/m³ 4h

Hexanes (110-54-3)

Inhalation LC50 Rat > 20 mg/l 4h

Nitrogen (7727-37-9)

Simple Asphyxiant

Carbon Dioxide (124-38-9)

Inhalation LC50 Human 100,000 ppm 1minute

Oxygen (7782-44-7)

N/A – Necessary for life

Potential Health Effects: Skin Corrosion Property / Stimulativeness

This product is not reported to have any skin sensitization effects.

Generative Cell Mutagenicity

This product is not reported to have any mutagenic effects.

Carcinogenicity

A: General Product Information

This product is not reported to have any carcinogenic effects.

B: Component Carcinogenicity

None of this product's components are listed by ACGIH, IARC, OSHA, NIOSH, or NTP.

Reproductive Toxicity

This product is not reported to have any reproductive toxicity effects.

Specified Target Organ General Toxicity: Single Exposure

This product may cause damage to the heart.

Specified Target Organ General Toxicity: Repeated Exposure

This product is not reported to have any specific target organ repeat effects.

Aspiration Respiratory Organs Hazard

This product is not reported to have any aspiration hazard effects.

SAFETY DATA SHEET

Material Name: Wet Field Natural Gas

*** Section 12 – ECOLOGICAL INFORMATION ***

Ecotoxicity

A: General Product Information

Keep gas and vapors out of sewers, drainage areas, and waterways. Report spills and releases, as applicable under Federal and State regulations.

B: Component Analysis – Ecotoxicity – Aquatic Toxicity

No ecotoxicity data are available for this product's components.

Persistence / Degradability

No information available.

Bioaccumulation

No information available.

Mobility in Soil

No information available.

*** Section 13 – DISPOSAL CONSIDERATIONS ***

Waste Disposal Instructions

See Section 7 for Handling Procedures. See Section 8 for Personal Protective Equipment Recommendations.

Disposal of Contaminated Containers or Packaging

Dispose of contents / container in accordance with local / regional / national / international regulations.

*** Section 14 – TRANSPORTATION INFORMATION ***

DOT Information

Shipping Name: Natural Gas, Compressed

UN #: 1971 **Hazard Class:** 2.1

Placard:



SAFETY DATA SHEET

Material Name: Wet Field Natural Gas

***** Section 15 – REGULATORY INFORMATION *****

Regulatory Information

Component Analysis

None of this products components are listed under SARA Section 302 (40 CFR 355 Appendix A).

n-hexane is listed under SARA Section 313 (40 CFR 372.65). However the concentration of this component is approximately 0.01 % in compressed natural gas and is therefore far under the reporting threshold for the chemical.

n-hexane is listed under CERCLA (40 CFR 302.4). However the concentration of this component is approximately 0.01 % in compressed natural gas and is therefore far under the reporting threshold for the chemical.

SARA Section 311/312 – Hazard Classes

<u>Acute Health</u>	<u>Chronic Health</u>	<u>Fire</u>	<u>Sudden Release of Pressure</u>	<u>Reactive</u>
---	---	X	X	---

SARA Section 313 – Supplier Notification

This product contains one chemical (n-Hexane) that is subject to the reporting requirements of section 313 of the Emergency Planning and Community Right-to-know act (EPCRA) of 1986 and of 40 CFR 372. However the concentration of this component is approximately 0.01 % in compressed natural gas and is therefore far under the reporting threshold for the chemical.

State Regulations

Component Analysis – State

The following components appear on one or more of the following state hazardous substances lists:

Component	CAS	CA	MA	MN	NJ	PA	RI
Methane	74-82-8	No	No	Yes	Yes	Yes	No
Ethane	78-84-0	No	No	Yes	Yes	Yes	No
Propane	74-98-6	No	No	Yes	Yes	Yes	Yes
Butane	106-97-8	Yes	No	Yes	Yes	Yes	Yes
Pentanes	109-66-0	Yes	No	Yes	Yes	Yes	Yes
Hexanes	110-54-3	Yes	Yes	Yes	Yes	Yes	Yes
Nitrogen	7727-37-9	No	No	No	No	No	No
Carbon Dioxide	124-38-9	Yes	No	Yes	Yes	Yes	Yes
Oxygen	7782-44-7	No	No	No	No	No	No

SAFETY DATA SHEET

Material Name: Wet Field Natural Gas

*** Section 16 – OTHER INFORMATION ***

NFPA® Hazard Rating

Health	1
Fire	4
Reactivity	0

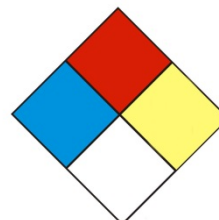

HMIS® Hazard Rating

Health	1	Moderate
Fire	4	Severe
Physical	0	Minimal

* Chronic

Key/Legend

EPA = Environmental Protection Agency; TSCA = Toxic Substance Control Act; ACGIH = American Conference of Governmental Industrial Hygienists; IARC = International Agency for Research on Cancer; NIOSH = National Institute for Occupational Safety and Health; NTP = National Toxicology Program; OSHA = Occupational Safety and Health Administration; NJTSR = New Jersey Trade Secret Registry.

Literature References

None

Other Information

The information presented herein has been compiled from sources considered to be dependable, and is accurate and reliable to the best of our knowledge and belief, but is not guaranteed to be so. Since conditions of use are beyond our control, we make no warranties, expressed or implied, except those that may be contained in our written contract of sale or acknowledgment.

Vendor assumes no responsibility for injury to vendee or third persons proximately caused by the material if reasonable safety procedures are not adhered to as stipulated in the data sheet. Additionally, vendor assumes no responsibility for injury to vendee or third persons proximately caused by abnormal use of the material, even if reasonable safety procedures are followed. Furthermore, vendee assumes the risk in their use of the material.

Date of Preparation: February 7, 2014

Date of Last Revision: March 4,, 2014

End of Sheet

Material Name: Dry Field Natural Gas

US GHS

SYNONYMS: CNG, Natural Gas, Methane.

***** Section 1 – PRODUCT AND COMPANY IDENTIFICATION *****

PRODUCT NAME: Dry Field Natural Gas EMERGENCY PHONE: (800) 878-1373

PRODUCT CODES: CAS Reg. No. 68410-63-9 AFTER HOURS: (800) 878-1373

PRODUCER: Antero Resources

ADDRESS: 1615 Wynkoop Street CHEMTREC PHONE: (800) 424-9300
Denver, Colorado 80202

***** Section 2 – HAZARDS IDENTIFICATION *****

GHS Classification:

Flammable Gas – Category 1.

Gases Under Pressure – Gas.

Specific Target Organ Systemic Toxicity (STOT) – Single Exposure Category 2.

GHS LABEL ELEMENTS

Symbol(s)



Signal Word

Danger

Hazard Statements

Extremely flammable gas.

Contains gas under pressure, may explode if heated.

May cause damage to central nervous and respiratory systems.

Precautionary Statements

Prevention

Keep away from heat/sparks/open flames/hot surfaces. No smoking.

Do not breathe fume/gas/mist/vapors/spray.

Wash thoroughly after handling.

Do not eat, drink or smoke when using this product.

SAFETY DATA SHEET

Material Name: Dry Field Natural Gas

US GHS

Response

Leaking gas fire: Do not extinguish, unless leak can be stopped safely. Eliminate all ignition sources if safe to do so.

If exposed to gas, or concerned about possible exposure: Call a POISON CENTER or doctor/physician.

Storage

Protect from sunlight. Store in a well-ventilated place.

Store in a secure area.

Disposal

Dispose of contents/containers in accordance with local/regional/national/international regulations.

*** Section 3 – COMPOSITION / INFORMATION ON INGREDIENTS ***

CAS #	Component	Percent
74-82-8	Methane	95.01
78-84-0	Ethane	3.99
74-98-6	Propane	0.32
106-97-8	Butanes	0.07
109-66-0	Pentanes	0.02
110-54-3	Hexanes	0.01
7727-37-9	Nitrogen	0.35
124-38-9	Carbon Dioxide	0.19
7782-44-7	Oxygen	0.03

Because natural gas is a natural product, composition can vary greatly.

*** Section 4 – FIRST AID MEASURES ***

First Aid: Eyes

In case of freeze burn, cover eyes to protect from light. Flush eyes with running water for at least fifteen (15) minutes. Following flushing, seek medical attention.

First Aid: Skin

Remove contaminated clothing. In case of blistering, frostbite or freeze burns, seek immediate medical attention.

SAFETY DATA SHEET

Material Name: Dry Field Natural Gas

US GHS

First Aid: Ingestion

Risk of ingestion is extremely low. However, if oral exposure occurs, seek immediate medical assistance.

First Aid: Inhalation

Remove person to fresh air. If person is not breathing, provide artificial respiration. If necessary, provide additional oxygen once breathing is restored if trained to do so. Seek medical attention immediately.

***** Section 5 – FIRE FIGHTING MEASURES *****

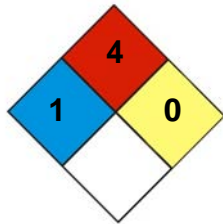

NFPA 704 Hazard Class

Health: **1** Flammability: **4** Instability: **0** (0-Minimal, 1-Slight, 2-Moderate, 3-Serious, 4-Severe)

General Fire Hazards

See Section 9 for Flammability Properties.

Forms a flammable mixture with air. If released, the resulting vapors will disperse with the prevailing wind. If a source of ignition is present where the vapor exists at a 5 – 15% concentration in air, the vapor will burn along the flame front toward the source of the fuel.

Hazardous Combustion Products

Carbon monoxide, carbon dioxide and non-combusted hydrocarbons (smoke).

Extinguishing Media

Any extinguisher suitable for Class B fires, dry chemical, fire fighting foam, CO₂, and other gaseous agents. However, fire should not be extinguished unless flow of gas can be immediately stopped.

Unsuitable Extinguishing Media

None.

Fire Fighting Equipment / Instructions

Gas fires should not be extinguished unless flow of gas can be immediately stopped. Shut off gas source and allow gas to burn out. If spill or leak has not ignited, determine

SAFETY DATA SHEET

Material Name: Dry Field Natural Gas

US GHS

if water spray may assist in dispersing gas or vapor to protect personnel attempting to stop leak. Use water to cool equipment, surfaces and piping exposed to fire and excessive heat. For large fire, the use of unmanned hose holders or monitor nozzles may be advantageous to further minimize personnel exposure. Isolate area, particularly around piping. Let the fire burn unless leak can be stopped. Concentrate fire-fighting efforts on objects / materials ignited by the initial fire. Withdraw immediately in the event of a rising sound from a venting safety device.

Firefighting activities that may result in potential exposure to high heat, smoke or toxic by-products of combustion should require NIOSH-approved pressure-demand self-contained breathing apparatus with full facepiece and full protective clothing.

*** Section 6 – ACCIDENTAL RELEASE MEASURES ***

Recovery and Neutralization

Stop the source of the release, if safe to do so.

Materials and Methods for Clean-Up

Consider the use of water spray to disperse gas vapors. Do not use water spray to direct gas vapors toward sewer or drainage systems. Isolate the area until gas has dispersed. Ventilate and gas test area before entering.

Emergency Measures

Evacuate nonessential personnel and secure all ignition sources. No road flares, smoking or flames in hazard area. Consider wind direction. Stay upwind and uphill, if possible. Vapor cloud may be white, but color will dissipate as cloud disperses. Fire and explosion hazard is still present.

Personal Precautions and Protective Equipment

Cooling effect of expanding gas from leak may present frostbite / freeze burn hazard. Wear flame retardant (FR) clothing around un-ignited leak. Wear fire protective clothing around an active fire.

Environmental Precautions

Do not flush gas vapors toward sewer or drainage systems.

Prevention of Secondary Hazards

None.

SAFETY DATA SHEET

Material Name: Dry Field Natural Gas

US GHS

*** Section 7 – HANDLING AND STORAGE ***

Handling Procedures

Keep away from flame, sparks and excessive temperatures. Bond and ground containers. Use only in well ventilated areas.

Storage Procedures

Natural gas will be contained in the pipeline. Keep away from flame, sparks, excessive temperatures and open flames. Empty pipeline segments may contain explosive residues from natural gas liquids. Do not cut, heat, weld or expose containers to sources of ignition sections of pipeline unless the sections have been purged of natural gas residues.

Incompatibilities

Keep away from strong oxidizers, ignition sources and heat.

*** Section 8 – EXPOSURE CONTROLS / PERSONAL PROTECTION ***

Component Exposure Limits

Methane (74-82-8)

ACGIH: 1000 ppm TWA (listed under Aliphatic hydrocarbon gases : Alkane C1-4)

Ethane (74-84-0)

ACGIH: 1000 ppm TWA (listed under Aliphatic hydrocarbon gases : Alkane C1-4)

Propane (74-98-6)

ACGIH: 2500 ppm TWA (listed under Aliphatic hydrocarbon gases : Alkane C1-4)

Butane (106-97-8)

ACGIH: 800 ppm TWA (listed under Aliphatic hydrocarbon gases : Alkane C1-4)

Pentanes (109-66-0)

ACGIH: 600 ppm TWA (listed under Pentane, all isomers)

Hexanes (110-54-3)

ACGIH: 50 ppm TWA (listed under n-Hexane)

SAFETY DATA SHEET

Material Name: Dry Field Natural Gas

US GHS

Nitrogen (7727-37-9)

Simple Asphyxiant

Carbon Dioxide (124-38-9)

ACGIH: 5000 ppm TWA (listed under Carbon Dioxide)

Oxygen (7782-44-7)

N/A – Necessary for life

Engineering Measures

Use adequate ventilation to keep gas and vapor concentrations of this product below occupational exposure and flammability limits, particularly in confined spaces. Use explosion-proof equipment and lighting in classified / controlled areas.

Personal Protective Equipment: Respiratory

Use a NIOSH approved positive-pressure, supplied air respirator with escape bottle or self-contained breathing apparatus (SCBA) for gas concentrations above occupational exposure limits, for potential for uncontrolled release, if exposure levels are not known, or in an oxygen-deficient atmosphere. CAUTION: Flammability limits (i.e., explosion hazard should be considered when assessing the need to expose personnel to concentrations requiring respiratory protection.

Personal Protective Equipment: Hands

Use cold-impervious, insulating flame-retardant (FR) gloves where contact with pressurized gas may occur.

Personal Protective Equipment: Eyes

Where there is a possibility of pressurized gas contact, wear splash-proof safety goggles and faceshield.

Personal Protective Equipment: Skin and Body

Where contact with pressurized gas may occur, wear flame-retardant (FR) and a faceshield.

***** Section 9 – PHYSICAL AND CHEMICAL PROPERTIES *****

Appearance: Colorless	Odor: Odorless to slight petroleum odor
Physical State: Gas	pH: ND
Vapor Pressure: 40 atm @ -187°F (-86°C)	Vapor Density: 0.6
Boiling Point: -259°F (-162°C)	Melting Point: ND
Solubility (H2O): 3.5%	Specific Gravity: 0.4 @ -263°F (-164°C)

SAFETY DATA SHEET

Material Name: Dry Field Natural Gas

US GHS

Evaporation Rate:	ND	VOC:	ND
Octanol / H ₂ O Coeff.:	ND	Flash Point:	Flammable Gas
Flash Point Method:	N/A		
Lower Flammability Limit:	3.8 – 6.5	Upper Flammability Limit:	13-17
(LFL):		(UFL):	
Auto Ignition:	900-1170°F (482-632°C)	Burning Rate:	ND

*** Section 10 – CHEMICAL STABILITY & REACTIVITY INFORMATION ***

Chemical Stability

This is a stable material.

Hazardous Reaction Potential

Will not occur.

Conditions to Avoid

Keep away from strong oxidizers, ignition sources and heat.

Hazardous Decomposition Products

Carbon monoxide, carbon dioxide and non-combusted hydrocarbons (smoke).

*** Section 11 – TOXICOLOGICAL INFORMATION ***

Acute Toxicity

A: General Product Information

Methane and ethane, the main components of natural gas, are considered practically inert in terms of physiological effects. At high concentrations these materials act as simple asphyxiants and may cause death due to lack of oxygen.

B. Component Analysis – LD50/LC50

Methane (74-82-8)

Inhalation LC50 Mouse 326 g/m³ 2h

Ethane (74-84-0)

Inhalation LC50 Rat 658 mg/l 4h

Propane (74-98-6)

Inhalation LC50 Rat 658 mg/l 4h

SAFETY DATA SHEET

Material Name: Dry Field Natural Gas

US GHS

Butanes (106-97-8)

Inhalation LC50 Rat 658 g/m³ 4h

Pentanes (109-66-0)

Inhalation LD50 Rat 364 g/m³ 4h

Hexanes (110-54-3)

Inhalation LC50 Rat > 20 mg/l 4h

Nitrogen (7727-37-9)

Simple Asphyxiant

Carbon Dioxide (124-38-9)

Inhalation LC50 Human 100,000 ppm 1minute

Oxygen (7782-44-7)

N/A – Necessary for life

Potential Health Effects: Skin Corrosion Property / Stimulativeness

This product is not reported to have any skin sensitization effects.

Generative Cell Mutagenicity

This product is not reported to have any mutagenic effects.

Carcinogenicity

A: General Product Information

This product is not reported to have any carcinogenic effects.

B: Component Carcinogenicity

None of this product's components are listed by ACGIH, IARC, OSHA, NIOSH, or NTP.

Reproductive Toxicity

This product is not reported to have any reproductive toxicity effects.

Specified Target Organ General Toxicity: Single Exposure

This product may cause damage to the heart.

Specified Target Organ General Toxicity: Repeated Exposure

This product is not reported to have any specific target organ repeat effects.

Aspiration Respiratory Organs Hazard

This product is not reported to have any aspiration hazard effects.

SAFETY DATA SHEET

Material Name: Dry Field Natural Gas

US GHS

*** Section 12 – ECOLOGICAL INFORMATION ***

Ecotoxicity

A: General Product Information

Keep gas and vapors out of sewers, drainage areas, and waterways. Report spills and releases, as applicable under Federal and State regulations.

B: Component Analysis – Ecotoxicity – Aquatic Toxicity

No ecotoxicity data are available for this product's components.

Persistence / Degradability

No information available.

Bioaccumulation

No information available.

Mobility in Soil

No information available.

*** Section 13 – DISPOSAL CONSIDERATIONS ***

Waste Disposal Instructions

See Section 7 for Handling Procedures. See Section 8 for Personal Protective Equipment Recommendations.

Disposal of Contaminated Containers or Packaging

Dispose of contents / container in accordance with local / regional / national / international regulations.

*** Section 14 – TRANSPORTATION INFORMATION ***

DOT Information

Shipping Name: Natural Gas, Compressed

UN #: 1971 **Hazard Class:** 2.1

Placard:



SAFETY DATA SHEET

Material Name: Dry Field Natural Gas

US GHS

***** Section 15 – REGULATORY INFORMATION *****

Regulatory Information

Component Analysis

None of this products components are listed under SARA Section 302 (40 CFR 355 Appendix A).

n-hexane is listed under SARA Section 313 (40 CFR 372.65). However the concentration of this component is approximately 0.01 % in compressed natural gas and is therefore far under the reporting threshold for the chemical.

n-hexane is listed under CERCLA (40 CFR 302.4). However the concentration of this component is approximately 0.01 % in compressed natural gas and is therefore far under the reporting threshold for the chemical.

SARA Section 311/312 – Hazard Classes

<u>Acute Health</u>	<u>Chronic Health</u>	<u>Fire</u>	<u>Sudden Release of Pressure</u>	<u>Reactive</u>
---	---	X	X	---

SARA Section 313 – Supplier Notification

This product contains one chemical (n-Hexane) that is subject to the reporting requirements of section 313 of the Emergency Planning and Community Right-to-know act (EPCRA) of 1986 and of 40 CFR 372. However the concentration of this component is approximately 0.01 % in compressed natural gas and is therefore far under the reporting threshold for the chemical.

State Regulations

Component Analysis – State

The following components appear on one or more of the following state hazardous substances lists:

Component	CAS	CA	MA	MN	NJ	PA	RI
Methane	74-82-8	No	No	Yes	Yes	Yes	No
Ethane	78-84-0	No	No	Yes	Yes	Yes	No
Propane	74-98-6	No	No	Yes	Yes	Yes	Yes
Butane	106-97-8	Yes	No	Yes	Yes	Yes	Yes
Pentanes	109-66-0	Yes	No	Yes	Yes	Yes	Yes
Hexanes	110-54-3	Yes	Yes	Yes	Yes	Yes	Yes
Nitrogen	7727-37-9	No	No	No	No	No	No
Carbon Dioxide	124-38-9	Yes	No	Yes	Yes	Yes	Yes
Oxygen	7782-44-7	No	No	No	No	No	No

SAFETY DATA SHEET

Material Name: Dry Field Natural Gas

US GHS

*** Section 16 – OTHER INFORMATION ***

NFPA® Hazard Rating

Health 1
Fire 4
Reactivity 0

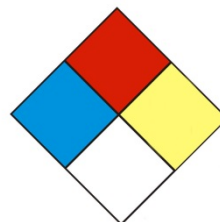

HMIS® Hazard Rating

Health 1 Moderate
Fire 4 Severe
Physical 0 Minimal
* Chronic

Key/Legend

EPA = Environmental Protection Agency; TSCA = Toxic Substance Control Act; ACGIH = American Conference of Governmental Industrial Hygienists; IARC = International Agency for Research on Cancer; NIOSH = National Institute for Occupational Safety and Health; NTP = National Toxicology Program; OSHA = Occupational Safety and Health Administration; NJTSR = New Jersey Trade Secret Registry.

Literature References

None

Other Information

The information presented herein has been compiled from sources considered to be dependable, and is accurate and reliable to the best of our knowledge and belief, but is not guaranteed to be so. Since conditions of use are beyond our control, we make no warranties, expressed or implied, except those that may be contained in our written contract of sale or acknowledgment.

Vendor assumes no responsibility for injury to vendee or third persons proximately caused by the material if reasonable safety procedures are not adhered to as stipulated in the data sheet. Additionally, vendor assumes no responsibility for injury to vendee or third persons proximately caused by abnormal use of the material, even if reasonable safety procedures are followed. Furthermore, vendee assumes the risk in their use of the material.

Date of Preparation: January 30, 2014

Date of Last Revision: March 4, 2014

End of Sheet

**Material Safety Data Sheet
(TRIETHYLENE GLYCOL (TEG))**

JMN Specialties, Inc. 1100 Victory Drive Westwego, LA 70094 (504) 341-3749 ISO 9001 Registered	HMIS HEALTH:2 HMIS FLAMMABILITY:1 HMIS REACTIVITY:0 PERSONAL PROTECTION:C EMERGENCY NUMBER:800-255-3924
---	--

SECTION 1 – IDENTIFICATION OF CHEMICAL PRODUCT

PRODUCT NAME:..... TRIETHYLENE GLYCOL (TEG)
EFFECTIVE DATE:..... October 1, 2007
CHEMICAL FAMILY:..... Glycol
FORMULA: C₆H₁₄O₄
CAS NUMBER:..... 112-27-6

SECTION 2 – COMPOSITION / INFORMATION ON INGREDIENTS

HAZARDOUS INGREDIENT	PERCENT	CAS NUMBER	PEL
TRIETHYLENE GLYCOL	> 99	112-27-6	None Established by ACGIH or OSHA.

The criteria for listing components in the composition section are as follows: Carcinogens are listed when present at 0.1% or greater; components which are otherwise hazardous according to OSHA are listed when present at 1.0% or greater. Non-hazardous components may be listed at 3.0% or greater if not proprietary in nature. This is not intended to be complete compositional disclosure. Refer to section 14 for applicable states right to know and other regulatory information.

SECTION 3 – HAZARDS IDENTIFICATION

EMERGENCY OVERVIEW

APPEARANCE / ODOR: Clear Liquid / Mild Odor
SHORT TERM EXPOSURE: **Inhalation:** No adverse health effects expected from inhalation.
 Ingestion: No adverse effects expected. **Skin Contact:** Prolonged exposure may cause skin irritation. **Eye Contact:** Splashing in eye causes irritation with transitory disturbances of corneal epithelium. However, these effects diminish and no permanent injury is expected. Vapors are non-irritating. **Chronic Exposure:** Possible skin irritation. **Aggravation of Pre-existing Conditions:** No information found.
OSHA REGULATED: No
LISTED CARCINOGEN: NTP: No **IARC MONOGRAPHS:** No

POTENTIAL HEALTH EFFECTS

INHALATION: Unlikely
INGESTION: Irritant
SKIN (DERMAL): Slight Irritant After Prolonged Contact

Material Safety Data Sheet (TRIETHYLENE GLYCOL (TEG))

OVER EXPOSURE EFFECTS: **Inhalation:** No adverse health effects expected from inhalation. **Ingestion:** No adverse effects expected. **Skin Contact:** Prolonged exposure may cause skin irritation. **Eye Contact:** Splashing in eye causes irritation with transitory disturbances of corneal epithelium. However, these effects diminish and no permanent injury is expected. Vapors are non-irritating. **Chronic Exposure:** Possible skin irritation. **Aggravation of Pre-existing Conditions:** No information found.

SECTION 4 – FIRST AID MEASURES

FIRST AID: **SKIN CONTACT:** Remove contaminated clothing and shoes immediately. Wash affected area with soap or mild detergent and large amounts of water until no evidence of chemical remains (at least 15-20 minutes). Get medical attention immediately. **EYE CONTACT:** Flush eyes immediately with large amounts of water or normal saline solution, occasionally lifting upper and lower lids until no evidence of chemical remains (at least 15-20 minutes). Get medical attention immediately. **INGESTION:** Give large amounts of fresh water or milk immediately. Do not give anything by mouth if person is unconscious or otherwise unable to swallow. If vomiting occurs, keep head below hips to prevent aspiration. Treat symptomatically and supportively. Seek medical attention immediately. **INHALATION:** Remove from exposure area to fresh air immediately. If breathing has stopped, perform artificial resuscitation. Keep person warm and at rest. Treat symptomatically and supportively. Seek medical attention immediately. Qualified medical personnel should consider administering oxygen.

NOTE TO PHYSICIAN: Ethylene Glycol (EG) and diethylene glycol (DEG) intoxication may initially produce behavioral changes, drowsiness, vomiting, diarrhea, thirst, and convulsions. EG and DEG are nephrotoxic. End stages of poisoning may include renal damage or failure with acidosis. Supportive measures, supplemented with hemodialysis if indicated, may limit the progression and severity of toxic effects. Primary toxic effects of EG when swallowed are kidney damage and metabolic acidosis. This product may contain trace amounts of Ethylene Glycol (EG) or Diethylene Glycol (DEG).

SECTION 5 - FIRE FIGHTING MEASURES

FLASHPOINT:..... 350°F
EXTINGUISHING MEDIA: Water fog or spray, Foam, Dry Powder, Carbon Dioxide (CO₂).
DECOMPOSITION
PRODUCTS:..... From fire; Smoke, Carbon dioxide, & Carbon Monoxide
LOWER FLAME LIMIT:..... < 0.9
HIGHER FLAME LIMIT:..... > 9
UNUSUAL FIRE AND
EXPLOSION HAZARDS:..... Toxic levels of carbon monoxide, carbon dioxide, irritation aldehydes and ketones may be formed on burning. Heating in air may produce irritating aldehydes, acids, and ketones.

FIRE FIGHTING

**Material Safety Data Sheet
(TRIETHYLENE GLYCOL (TEG))**

EQUIPMENT:..... Fire fighters and others exposed to products of combustion should wear self-contained breathing apparatus. Equipment should be thoroughly decontaminated after use.

SECTION 6 – ACCIDENTAL RELEASE MEASURES

CHEMTEL EMERGENCY

NUMBER (24 Hour): 1-800-255-3924

SPILL: Ventilate area of leak or spill. Wear appropriate personal protective equipment as specified in Section 8. Isolate hazard area. Keep unnecessary and unprotected personnel from entering. Contain and recover liquid when possible. Collect liquid in an appropriate container or absorb with an inert material (e. g., vermiculite, dry sand, earth), and place in a chemical waste container. Do not use combustible materials, such as saw dust. Do not flush to sewer!

RCRA STATUS: None

SECTION 7 – HANDLING AND STORAGE

HANDLE IN ACCORDANCE WITH GOOD INDUSTRIAL HYGIENE AND SAFETY PRACTICES. THESE PRACTICES INCLUDE AVOIDING UNNECESSARY EXPOSURE AND PROMPT REMOVAL OF MATERIAL FROM EYES, SKIN, AND CLOTHING.

HANDLING AND STORAGE: .. No special storage requirements. Do not store above 120°F.

PRECAUTIONARY

MEASURES: Provide fresh air ventilation during and after application. Close container after each use. Avoid prolonged or repeated contact with skin. Avoid contact with skin, eyes, and clothing. After handling this product, wash hands before eating, drinking, or smoking. If needed, take first aid action shown in Section 4.

SECTION 8 – EXPOSURE CONTROL / PERSONAL PROTECTION

GENERAL CONSIDERATIONS:

Consider the potential hazards of this material (see section 3), applicable exposure limits, job activities, and other substances in the work place when designing engineering controls and selecting personal protective equipment.

EYE PROTECTION:..... Chemical safety goggles meeting the specifications of OSHA 29CFR 1910.133 / ANSI Standard Z87.1 should be worn whenever there is the possibility of splashing or other contact with the eyes. Wear safety glasses meeting the specifications of OSHA 29CFR 1910.133 / ANSI Standard Z87.1 where no contact with the eye is anticipated.

RESPIRATORY

PROTECTION:..... Not normally needed. Use NIOSH approved vapor respirator if exposure is unknown or exceeds permissible limits. A respiratory protection program that meets OSHA's 29 CFR 1910.134 or ANSI Z88.2 requirements must be followed whenever workplace conditions warrant respirator use.

Use NIOSH / MSHA approved respiratory protection equipment when airborne exposure limits are exceeded (see below). Consult the respirator manufacturer to determine appropriate type of

Material Safety Data Sheet (TRIETHYLENE GLYCOL (TEG))

equipment for a given application. Observe respirator use limitations specified by NIOSH / MSHA or the manufacturer. Respiratory protection programs must comply with 29 CFR 1910.134.

WARNING: Air-purifying respirators do not protect workers in oxygen-deficient atmospheres.

PROTECTIVE GLOVES:..... Wear impervious gloves

VENTILATION: A system of local and/or general exhaust is recommended to keep employee exposures below the Airborne Exposure Limits. Local exhaust ventilation is generally preferred because it can control the emissions of the contaminant at its source, preventing dispersion of it into the general work area. Please refer to the ACGIH document, *Industrial Ventilation, A Manual of Recommended Practices*, most recent edition, for details.

MECHANICAL EXHAUST: Desired in closed places

LOCAL EXHAUST: Recommended

VENTILATION NOTES: Provide natural or mechanical ventilation to control exposure levels below Airborne exposure limits (see below). The use of local mechanical exhaust ventilation is preferred at sources of air contamination such as open process equipment. Consult NFPA Standard 91 for design of exhaust systems.

THRESHOLD LIMIT VALUE: . None Established

PROTECTIVE EQUIPMENT:... HMIS PERSONAL PROTECTION: C: Safety Glasses, Gloves, Apron
The user should read and understand all instructions and limitations supplied with the equipment since protection is usually provided for a limited time or under certain circumstances.

SECTION 9 - PHYSICAL AND CHEMICAL PROPERTIES

APPEARANCE / ODOR: Clear Liquid / Mild Odor

BOILING POINT: > 500°F

FREEZING POINT: < 32°F

VAPOR PRESSURE:..... > 1

VAPOR DENSITY (AIR=1): 5.1

SPECIFIC GRAVITY: 1.1

pH: 8.2

SOLUBILITY IN WATER: Complete

SECTION 10 – STABILITY AND REACTIVITY

STABILITY:..... Stable

HAZARDOUS

POLYMERIZATION: Will Not Occur

POLYMERIZATION AVOID:... None

INCOMPATIBILITY: Explosive decomposition may occur if combined with strong acids or strong bases and subjected to elevated temperatures. Therefore, avoid strong acids and strong bases at elevated temperatures. Avoid contamination with strong oxidizing agents and materials reactive with hydroxyl compounds. Avoid burning or heating in air. This may produce irritating aldehydes, acids, and ketones.

CONDITIONS TO AVOID:..... Excessive heat. Will ignite in air at 700°F

**Material Safety Data Sheet
(TRIETHYLENE GLYCOL (TEG))**

SECTION 11 – TOXICOLOGICAL INFORMATION

EYE EFFECTS:

The eye irritation hazard is based on data from information supplied by raw material(s) supplier(s).

SKIN EFFECTS:

The skin irritation hazard is based on data from information supplied by raw material(s) supplier(s).

ACUTE ORAL EFFECTS:

The acute oral toxicity is based on data from information supplied by raw material(s) supplier(s).

ACUTE INHALATION EFFECTS:

The acute respiratory toxicity is based on data from information supplied by raw material(s) supplier(s).

SECTION 12 – ECOLOGICAL INFORMATION

Data from laboratory studies and from scientific literature is noted below if available.

SECTION 13 DISPOSAL CONSIDERATIONS

WASTE DISPOSAL: Treatment, storage, transportation and disposal must be in accordance with Federal, State/Provincial and Local Regulations. Regulations may vary in different locations. Characterization and compliance with applicable laws are the responsibility solely of the generator. Whatever cannot be saved for recovery or recycling should be managed in an appropriate and approved waste disposal facility. Processing, use or contamination of this product may change the waste management options. State and local disposal regulations may differ from federal disposal regulations. Dispose of container and unused contents in accordance with federal, state and local requirements.

SECTION 14- TRANSPORTATION INFORMATION

The data provided in this section is for information only. The description shown may not apply to all shipping situations. Consult 49CFR, or appropriate regulations to properly classify your shipment for transportation.

PROPER SHIPPING NAME:..... DOT NON-REGULATED - TRIETHYLENE GLYCOL (TEG)

REPORTABLE QUANTITY:..... None

HAZARD CLASS AND LABEL: NON-REGULATED

UN NUMBER: None

NA NUMBER: None

PACKAGING SIZE:..... Pail, Drum & Bulk

SECTION 15 - REGULATORY INFORMATION

SARA 311 CATEGORIES:

EPA ACUTE:..... Yes (Eyes)

**Material Safety Data Sheet
(TRIETHYLENE GLYCOL (TEG))**

EPA CHRONIC: No
EPA IGNITABILITY: No
EPA REACTIVITY: No
EPA SUDDEN RELEASE
OF PRESSURE: No

CERCLA RQ VALUE: None
SARA TPQ: None
SARA RQ: None
EPA HAZARD WASTE #: None
CLEAN AIR: NA
CLEAN WATER: NA
SARA SECTION 313: No
NFPA HEALTH: 2
NFPA FLAMMABILITY: 1
NFPA REACTIVITY: 0
DEA Chemical Trafficking Act:.. No

TSCA STATUS: All ingredients in this product are on the TSCA Inventory List.

SECTION 16 - ADDITIONAL INFORMATION
--

FOOT NOTES: NA - NOT APPLICABLE ND - NO DATA AVAILABLE > = GREATER THAN < = LESS THAN

Prepared according to the OSHA Hazard Communication Standard (29 CFR 1910.1200) and the ANSI MSDS Standard (Z400.1) by the Company Health and Risk Assessment Unit, PO Box 1519, Gretna, LA 70054-1519.

REVISION STATEMENT: Changes have been made throughout this Material Safety Data Sheet. Please read the entire document.

DISCLAIMER:

Although the information and recommendations set forth herein (hereinafter "Information") are presented in good faith and believed to be correct as of the date hereof, the Company makes no representations as to the completeness or accuracy thereof. Information is supplied upon the condition that the persons receiving this MSDS will make their own determination as to its suitability for their intended purposes prior to use. Since the product is within the exclusive control of the user, it is the user's obligation to determine the conditions of safe use of this product. Such conditions should comply with all Federal Regulations concerning the Product. It must be recognized that the physical and chemical properties of any product may not be fully understood and that new, possibly hazardous products may arise from reactions between chemicals. The information given in this data sheet is based on our present knowledge and shall not constitute a guarantee for any specific product features and shall not establish a legally valid contractual relationship. **NO REPRESENTATIONS OR WARRANTIES, EITHER EXPRESS OR IMPLIED, OF MERCHANTABILITY, FITNESS FOR A PARTICULAR PURPOSE OR OF ANY OTHER NATURE ARE MADE HEREUNDER WITH RESPECT TO INFORMATION OR THE PRODUCT TO WHICH INFORMATION REFERS.**

THIS IS THE LAST PAGE OF THIS MSDS

**Attachment I.
Emission Units Table**

Attachment I
Emission Units Table
(includes all emission units and air pollution control devices
that will be part of this permit application review, regardless of permitting status)

Emission Unit ID ¹	Emission Point ID ²	Emission Unit Description	Year Installed/ Modified	Design Capacity	Type ³ and Date of Change	Control Device ⁴
C-01	1E	Flare Combustion Device 1	2015	4.8 MMBtu/hr	NA	NA
CE-01	15E	Compressor Engine #1	2016	1680 hp	NA	NSCR (C-02)
CE-02	16E	Compressor Engine #2	2016	1680 hp	NA	NSCR (C-03)
CE-03	17E	Compressor Engine #3	2016	1680 hp	NA	NSCR (C-04)
CE-04	18E	Compressor Engine #4	2016	1680 hp	NA	NSCR (C-05)
CE-05	19E	Compressor Engine #5	2016	1680 hp	NA	NSCR (C-06)
CE-06	20E	Compressor Engine #6	2016	1680 hp	NA	NSCR (C-07)
CE-07	21E	Compressor Engine #7	2016	1680 hp	NA	NSCR (C-08)
CE-08	22E	Compressor Engine #8	2016	1680 hp	NA	NSCR (C-09)
CE-09	23E	Compressor Engine #9	2016	1680 hp	NA	NSCR (C-10)
CE-10	24E	Compressor Engine #10	2016	1680 hp	NA	NSCR(C-11)
CE-11	25E	Compressor Engine #11	2016	1680 hp	NA	NSCR(C-12)
GEN-1	26E	Microturbine Generator #1	2015	200 kWe	NA	None
GEN-2	27E	Microtrubine Generator #2	2015	200 kWe	NA	None
RSV-1	29E	Dehydrator Still Vent #1	2017	110 MMscfd	Modification	Combustor (C-01)
RBV-1	28E	Dehydrator Reboiler #1	2017	1.5 mmbtu/hr	Modification	None
RSV-2	31E	Dehydrator Still Vent #2	2017	110 MMscfd	Modification	Combustor (C-01)
RBV-2	30E	Dehydrator Reboiler #2	2017	1.5 mmbtu/hr	Modification	None
T03	34E	Settling Tank 1	2015	500 barrel	NA	VRUs (C-13 and C-14)
T04	35E	Condensate Tank 1	2015	400 barrel	NA	VRUs (C-13 and C-14)
T05	36E	Condensate Tank 2	2015	400 barrel	NA	VRUs (C-13 and C-14)
T01	32E	Produced Water Tank 1	2015	400 barrel	NA	VRUs (C-13 and C-14)
T02	33E	Produced Water Tank 2	2015	400 barrel	NA	VRUs (C-13 and C-14)

C-02	2E	NSCR Catalyst for Compressor #1	2016	-----	NA	None
C-03	3E	NSCR Catalyst for Compressor #2	2016	-----	NA	None
C-04	4E	NSCR Catalyst for Compressor #3	2016	-----	NA	None
C-05	5E	NSCR Catalyst for Compressor #4	2016	-----	NA	None
C-06	6E	NSCR Catalyst for Compressor #5	2016	-----	NA	None
C-07	7E	NSCR Catalyst for Compressor #6	2016	----	NA	None
C-08	8E	NSCR Catalyst for Compressor #7	2016	----	NA	None
C-09	9E	NSCR Catalyst for Compressor #8	2016	----	NA	None
C-10	10E	NSCR Catalyst for Compressor #9	2016	----	NA	None
C-11	11E	NSCR Catalyst for Compressor #10	2016	----	NA	None
C-12	12E	NSCR Catalyst for Compressor #11	2016	----	NA	None
C-13	13E	Vapor Recovery Unit 1	2015	46 MSCFD	NA	None
C-14	14E	Vapor Recovery Unit 2	2015	46 MSCFD	NA	None
EPLOR	37E	Truck Loadout	2015	71,395 bbl/yr	NA	None
CATHT1	47E	Catalytic Heater	2015	24,000 btu/hr	NA	None
CE-12	48E	Compressor Engine #12	2016	1680 hp	NA	NSCR (C-15)
CE-13	49E	Compressor Engine #13	2016	1680 hp	NA	NSCR (C-16)
C-15	50E	NSCR Catalyst for Compressor #12	2016	----	NA	None
C-16	51E	NSCR Catalyst for Compressor #13	2016	----	NA	None
FUEL1	52E	Fuel Conditioning Heater	2017	0.5 MMBtu/hr	New	None

¹ For Emission Units (or Sources) use the following numbering system: 1S, 2S, 3S,... or other appropriate designation.

² For Emission Points use the following numbering system: 1E, 2E, 3E, ... or other appropriate designation.

³ New, modification, removal

⁴ For Control Devices use the following numbering system: 1C, 2C, 3C,... or other appropriate designation.

Attachment J.
Emission Point Data Summary Sheet

**Attachment J
EMISSION POINTS DATA SUMMARY SHEET**

Table 1: Emissions Data															
Emission Point ID No. (Must match Emission Units Table & Plot Plan)	Emission Point Type ¹	Emission Unit Vented Through This Point (Must match Emission Units Table & Plot Plan)		Air Pollution Control Device (Must match Emission Units Table & Plot Plan)		Vent Time for Emission Unit (chemical processes only)		All Regulated Pollutants - Chemical Name/CAS ³ (Speciate VOCs & HAPS)	Maximum Potential Uncontrolled Emissions ⁴		Maximum Potential Controlled Emissions ⁵		Emission Form or Phase (At exit conditions, Solid, Liquid or Gas/Vapor)	Est. Method Used ⁶	Emission Concentration ⁷ (ppmv or mg/m ⁴)
		ID No.	Source	ID No.	Device Type	Short Term ²	Max (hr/yr)		lb/hr	ton/yr	lb/hr	ton/yr			
1E/29E/31E	Upward Vertical Stack	C-01/RSV-1/RSV-2	Flare combustion device 1	---	---	C	8760	NOx	---	---	0.33	1.44	Gas/Vapor	EE	
								CO	---	---	1.78	7.79			
								VOC	41.53	181.89	0.73	3.21			
								PM10	---	---	0.0002	0.0007			
								SO2	---	---	1E-5	5E-5			
								Total HAPs	10.39	45.49	0.20	0.88			
								CO2e	983	4306	584	2558			
15E/2E	Upward Vertical Stack	CE-01	Compressor engine 1	C-02	NSCR catalyst	C	8760	NOx	50.37	220.62	1.26	5.52	Gas/Vapor	EE	
								CO	47.41	207.64	1.19	5.19			
								VOC	1.48	6.49	0.24	1.04			
								PM10	0.27	1.18	0.27	1.18			
								SO2	0.008	0.036	0.008	0.036			
								Total HAPs	0.35	1.54	0.050	0.22			
								Formaldehyde	0.19	0.81	0.019	0.081			
CO2e	2085	9133	1993	8727											
16E/3E	Upward Vertical Stack	CE-02	Compressor engine 2	C-03	NSCR catalyst	C	8760	NOx	50.37	220.62	1.26	5.52	Gas/Vapor	EE	
								CO	47.41	207.64	1.19	5.19			
								VOC	1.48	6.49	0.24	1.04			
								PM10	0.27	1.18	0.27	1.18			
								SO2	0.008	0.036	0.008	0.036			
								Total HAPs	0.35	1.54	0.050	0.22			
								Formaldehyde	0.19	0.81	0.019	0.081			
CO2e	2085	9133	1993	8727											

17E/4E	Upward Vertical Stack	CE-03	Com-pressor engine 3	C-04	NSCR catalyst	C	8760	NOx	50.37	220.62	1.26	5.52	Gas/Vapor	EE				
								CO	47.41	207.64	1.19	5.19						
								VOC	1.48	6.49	0.24	1.04						
								PM10	0.27	1.18	0.27	1.18						
								SO2	0.008	0.036	0.008	0.036						
								Total HAPs	0.35	1.54	0.050	0.22						
								Formaldehyde	0.19	0.81	0.019	0.081						
								CO2e	2085	9133	1993	8727						
18E/5E	Upward Vertical Stack	CE-04	Com-pressor engine 4	C-05	NSCR catalyst	C	8760	NOx	50.37	220.62	1.26	5.52	Gas/Vapor	EE				
								CO	47.41	207.64	1.19	5.19						
								VOC	1.48	6.49	0.24	1.04						
								PM10	0.27	1.18	0.27	1.18						
								SO2	0.008	0.036	0.008	0.036						
								Total HAPs	0.35	1.54	0.050	0.22						
								Formaldehyde	0.19	0.81	0.019	0.081						
								CO2e	2085	9133	1993	8727						
19E/6E	Upward Vertical Stack	CE-05	Com-pressor engine 5	C-06	NSCR catalyst	C	8760	NOx	50.37	220.62	1.26	5.52	Gas/Vapor	EE				
								CO	47.41	207.64	1.19	5.19						
								VOC	1.48	6.49	0.24	1.04						
								PM10	0.27	1.18	0.27	1.18						
								SO2	0.008	0.036	0.008	0.036						
								Total HAPs	0.35	1.54	0.050	0.22						
								Formaldehyde	0.19	0.81	0.019	0.081						
								CO2e	2085	9133	1993	8727						
20E/7E	Upward Vertical Stack	CE-06	Com-pressor engine 6	C-07	NSCR catalyst	C	8760	NOx	50.37	220.62	1.26	5.52	Gas/Vapor	EE				
								CO	47.41	207.64	1.19	5.19						
								VOC	1.48	6.49	0.24	1.04						
								PM10	0.27	1.18	0.27	1.18						
								SO2	0.008	0.036	0.008	0.036						
								Total HAPs	0.35	1.54	0.050	0.22						
								Formaldehyde	0.19	0.81	0.019	0.081						
								CO2e	2085	9133	1993	8727						

21E/8E	Upward Vertical Stack	CE-07	Com-pressor engine 7	C-08	NSCR catalyst	C	8760	NOx	50.37	220.62	1.26	5.52	Gas/Vapor	EE				
								CO	47.41	207.64	1.19	5.19						
								VOC	1.48	6.49	0.24	1.04						
								PM10	0.27	1.18	0.27	1.18						
								SO2	0.008	0.036	0.008	0.036						
								Total HAPs	0.35	1.54	0.050	0.22						
								Formaldehyde	0.19	0.81	0.019	0.081						
								CO2e	2085	9133	1993	8727						
22E/9E	Upward Vertical Stack	CE-08	Com-pressor engine 8	C-09	NSCR catalyst	C	8760	NOx	50.37	220.62	1.26	5.52	Gas/Vapor	EE				
								CO	47.41	207.64	1.19	5.19						
								VOC	1.48	6.49	0.24	1.04						
								PM10	0.27	1.18	0.27	1.18						
								SO2	0.008	0.036	0.008	0.036						
								Total HAPs	0.35	1.54	0.050	0.22						
								Formaldehyde	0.19	0.81	0.019	0.081						
								CO2e	2085	9133	1993	8727						
23E/10E	Upward Vertical Stack	CE-09	Com-pressor engine 9	C-10	NSCR catalyst	C	8760	NOx	50.37	220.62	1.26	5.52	Gas/Vapor	EE				
								CO	47.41	207.64	1.19	5.19						
								VOC	1.48	6.49	0.24	1.04						
								PM10	0.27	1.18	0.27	1.18						
								SO2	0.008	0.036	0.008	0.036						
								Total HAPs	0.35	1.54	0.050	0.22						
								Formaldehyde	0.19	0.81	0.019	0.081						
								CO2e	2085	9133	1993	8727						
24E/11E	Upward Vertical Stack	CE-10	Com-pressor engine 10	C-11	NSCR catalyst	C	8760	NOx	50.37	220.62	1.26	5.52	Gas/Vapor	EE				
								CO	47.41	207.64	1.19	5.19						
								VOC	1.48	6.49	0.24	1.04						
								PM10	0.27	1.18	0.27	1.18						
								SO2	0.008	0.036	0.008	0.036						
								Total HAPs	0.35	1.54	0.050	0.22						
								Formaldehyde	0.19	0.81	0.019	0.081						
								CO2e	2085	9133	1993	8727						

25E/12E	Upward Vertical Stack	CE-11	Compressor engine 11	C-12	NSCR catalyst	C	8760	NOx CO VOC PM10 SO2 Total HAPs Formaldehyde CO2e	50.37 47.41 1.48 0.27 0.008 0.35 0.19 2085	220.62 207.64 6.49 1.18 0.036 1.54 0.81 9133	1.26 1.19 0.24 0.27 0.008 0.050 0.019 1993	5.52 5.19 1.04 1.18 0.036 0.22 0.081 8727	Gas/Vapor	EE	
26E	Upward Vertical Stack	GEN-1	Microturbine Generator 1	----	----	C	8760	NOx CO VOC PM10 SO2 Total HAPs Formaldehyde CO2e	0.10 0.26 0.02 0.02 0.008 0.003 0.002 266	0.42 1.16 0.11 0.07 0.04 0.01 0.008 1166	0.10 0.26 0.02 0.02 0.008 0.003 0.002 266	0.42 1.16 0.11 0.07 0.04 0.01 0.008 1166	Gas/Vapor	EE	
27E	Upward Vertical Stack	GEN-2	Microturbine Generator 2	----	----	C	8760	NOx CO VOC PM10 SO2 Total HAPs Formaldehyde CO2e	0.10 0.26 0.02 0.02 0.008 0.003 0.002 266	0.42 1.16 0.11 0.07 0.04 0.01 0.008 1166	0.10 0.26 0.02 0.02 0.008 0.003 0.002 266	0.42 1.16 0.11 0.07 0.04 0.01 0.008 1166	Gas/Vapor	EE	
28E	Upward Vertical Stack	RBV-1	Dehydrator Reboiler 1	---	----	C	8760	NOx CO VOC PM10 SO2 Total HAPs Formaldehyde CO2e	0.15 0.12 44.95 0.011 0.001 1.16 0.0001 3023	0.64 0.54 196.90 0.049 0.004 5.09 0.0005 13239	0.15 0.12 0.91 0.011 0.001 0.026 0.0001 235	0.64 0.54 3.97 0.049 0.004 0.11 0.0005 1029	Gas/Vapor	EE	

30E	Upward Vertical Stack	RBV-2	Dehydrator Reboiler 2	---	----	C	8760	NOx CO VOC PM10 SO2 Total HAPs Formaldehyde CO2e	0.15 0.12 44.95 0.011 0.001 1.16 0.0001 3023	0.64 0.54 196.90 0.049 0.004 5.09 0.0005 13239	0.15 0.12 0.91 0.011 0.001 0.026 0.0001 235	0.64 0.54 3.97 0.049 0.004 0.11 0.0005 1029	Gas/Vapor	EE	
32E/13E &14E	Upward Vertical Stack	T01	Produced Water Tank 1	C-13, C-14	VRU-Closed Loop System	C	8760	VOC Total HAPs CO2e	0.09 0.007 0.23	0.38 0.03 1.02	0.002 1.4E-4 0.005	0.008 5.9E-4 0.02	Gas/Vapor	EE	
33E/13E &14E	Upward Vertical Stack	T02	Produced Water Tank 2	C-13, C-14	VRU-Closed Loop System	C	8760	VOC Total HAPs CO2e	0.09 0.007 0.23	0.38 0.03 1.02	0.002 1.4E-4 0.005	0.008 5.9E-4 0.02	Gas/Vapor	EE	
34E/13E &14E	Upward Vertical Stack	T03	Settler Tank	C-13, C-14	VRU-Closed Loop System	C	8760	VOC Total HAPs CO2e	91.66 7.31 252.5	401.49 32.02 1106	1.83 0.15 5.24	8.03 0.64 23	Gas/Vapor	EE	
35E/13E &14E	Upward Vertical Stack	T04	Condensate Tank 1	C-13, C-14	VRU-Closed Loop System	C	8760	VOC Total HAPs CO2e	1.28 0.10 3.47	5.60 0.44 15.20	0.03 0.002 0.07	0.11 0.009 0.30	Gas/Vapor	EE	
36E/13E &14E	Upward Vertical Stack	T05	Condensate Tank 2	C-13, C-14	VRU-Closed Loop System	C	8760	VOC Total HAPs CO2e	1.28 0.10 3.47	5.60 0.44 15.20	0.03 0.002 0.07	0.11 0.009 0.30	Gas/Vapor	EE	
47E	Upward Vertical Stack	CATHT 1	Catalytic Heater	---	---	C	8760	NOx CO VOC PM10 SO2 Total HAPs Formaldehyde CO2e	0.002 0.002 0.0001 0.0002 1E-5 4E-5 2E-6 2.82	0.01 0.009 0.0006 0.0008 6E-5 0.0002 8E-6 12.3	0.002 0.002 0.0001 0.0002 1E-5 4E-5 2E-6 2.82	0.01 0.009 0.0006 0.0008 6E-5 0.0002 8E-6 12.3	Gas/Vapor	EE	

48E/50E	Upward Vertical Stack	CE-12	Compressor engine 12	C-15	NSCR catalyst	C	8760	NOx	50.37	220.62	1.26	5.52	Gas/Vapor	EE	
								CO	47.41	207.64	1.19	5.19			
								VOC	1.48	6.49	0.24	1.04			
								PM10	0.27	1.18	0.27	1.18			
								SO2	0.008	0.036	0.008	0.036			
								Total HAPs	0.35	1.54	0.050	0.22			
								Formaldehyde	0.19	0.81	0.019	0.081			
								CO2e	2085	9133	1993	8727			
49E/51E	Upward Vertical Stack	CE-13	Compressor engine 13	C-16	NSCR catalyst	C	8760	NOx	50.37	220.62	1.26	5.52	Gas/Vapor	EE	
								CO	47.41	207.64	1.19	5.19			
								VOC	1.48	6.49	0.24	1.04			
								PM10	0.27	1.18	0.27	1.18			
								SO2	0.008	0.036	0.008	0.036			
								Total HAPs	0.35	1.54	0.050	0.22			
								Formaldehyde	0.19	0.81	0.019	0.081			
								CO2e	2085	9133	1993	8727			
52E	Upward Vertical Stack	FUEL1	Fuel Conditioning Heater	----	----	C	8760	NOx	0.049	0.21	0.049	0.21	Gas/Vapor	EE	
								CO	0.041	0.18	0.041	0.18			
								VOC	0.003	0.012	0.003	0.012			
								PM10	0.004	0.016	0.004	0.016			
								SO2	0.0003	0.0013	0.0003	0.0013			
								Total HAPs	0.0009	0.0040	0.0009	0.0040			
								Formaldehyde	4E-5	1.6e-4	4E-5	1.6e-4			
								CO2e	58.69	257.1	58.69	257.1			

The EMISSION POINTS DATA SUMMARY SHEET provides a summation of emissions by emission unit. Note that uncaptured process emission unit emissions are not typically considered to be fugitive and must be accounted for on the appropriate EMISSIONS UNIT DATA SHEET and on the EMISSION POINTS DATA SUMMARY SHEET. Please note that total emissions from the source are equal to all vented emissions, all fugitive emissions, plus all other emissions (e.g. uncaptured emissions). Please complete the FUGITIVE EMISSIONS DATA SUMMARY SHEET for fugitive emission activities.

¹ Please add descriptors such as upward vertical stack, downward vertical stack, horizontal stack, relief vent, rain cap, etc.

² Indicate by "C" if venting is continuous. Otherwise, specify the average short-term venting rate with units, for intermittent venting (ie., 15 min/hr). Indicate as many rates as needed to clarify frequency of venting (e.g., 5 min/day, 2 days/wk).

³ List all regulated air pollutants. Speciate VOCs, including all HAPs. Follow chemical name with Chemical Abstracts Service (CAS) number. **LIST** Acids, CO, CS₂, VOCs, H₂S, Inorganics, Lead, Organics, O₃, NO, NO₂, SO₂, SO₃, all applicable Greenhouse Gases (including CO₂ and methane), etc. **DO NOT LIST** H₂, H₂O, N₂, O₂, and Noble Gases.

⁴ Give maximum potential emission rate with no control equipment operating. If emissions occur for less than 1 hr, then record emissions per batch in minutes (e.g. 5 lb VOC/20 minute batch).

⁵ Give maximum potential emission rate with proposed control equipment operating. If emissions occur for less than 1 hr, then record emissions per batch in minutes (e.g. 5 lb VOC/20 minute batch).

⁶ Indicate method used to determine emission rate as follows: MB = material balance; ST = stack test (give date of test); EE = engineering estimate; O = other (specify).

⁷ Provide for all pollutant emissions. Typically, the units of parts per million by volume (ppmv) are used. If the emission is a mineral acid (sulfuric, nitric, hydrochloric or phosphoric) use units of milligram per dry cubic meter (mg/m³) at standard conditions (68 °F and 29.92 inches Hg) (see 45CSR7). If the pollutant is SO₂, use units of ppmv (See 45CSR10).

Attachment J
EMISSION POINTS DATA SUMMARY SHEET

Table 2: Release Parameter Data

Emission Point ID No. <i>(Must match Emission Units Table)</i>	Inner Diameter (ft.)	Exit Gas			Emission Point Elevation (ft)		UTM Coordinates (km)	
		Temp. (°F)	Volumetric Flow ¹ (acfm) <i>at operating conditions</i>	Velocity (fps)	Ground Level <i>(Height above mean sea level)</i>	Stack Height ² <i>(Release height of emissions above ground level)</i>	Northing	Easting
15E/C-02	1.1	1225	8886	156	1100	25	4349.298	511.254
16E/C-03	1.1	1225	8886	156	1100	25	4349.286	511.257
17E/C-04	1.1	1225	8886	156	1100	25	4349.274	511.258
18E/C-05	1.1	1225	8886	156	1100	25	4349.263	511.261
19E/C-06	1.1	1225	8886	156	1100	25	4349.251	511.262
20E/C-07	1.1	1225	8886	156	1100	25	4349.239	511.265
21E/C-08	1.1	1225	8886	156	1100	25	4349.227	511.267
22E/C-09	1.1	1225	8886	156	1100	25	4349.215	511.270
23E/C-10	1.1	1225	8886	156	1100	25	4349.204	511.271
24E/C-11	1.1	1225	8886	156	1100	25	4349.192	511.273
25E/C-12	1.1	1225	8886	156	1100	25	4349.179	511.276
26E	1.0	535	1.3 kg/s mass flow	67	1100	8	4349.225	511.208
27E	1.0	535	1.3 kg/s mass flow	67	1100	8	4349.146	511.424
29E/C-01 (1E)	4	1400	7540	10	1100	15	4349.297	511.220
28E	1.5	1000	965	9.1	1100	30	4349.281	511.214
31E/C-01 (1E)	4	1400	7540	10	1100	15	4349.297	511.220
30E	1.5	1000	965	9.10	1100	30	4349.272	511.211
32E-36E/C-13-C-14	Emissions captured in closed loop system with VRU				1100	NA	4349.368	511.286
47E	TBD	1300	TBD	TBD	1100	TBD	4349.217	511.201
48E/C-15	1.1	1225	8886	156	1100	25	4349.166	511.278

49E/C-16	1.1	1225	8886	156	1100	25	4349.156	511.281
52E	TBD	300	TBD	TBD	1100	TBD	4349.325	511.225

¹ Give at operating conditions. Include inerts.² Release height of emissions above ground level.

Attachment K.
Fugitive Emissions Data Summary Sheet

Attachment K

FUGITIVE EMISSIONS DATA SUMMARY SHEET

The FUGITIVE EMISSIONS SUMMARY SHEET provides a summation of fugitive emissions. Fugitive emissions are those emissions which could not reasonably pass through a stack, chimney, vent or other functionally equivalent opening. Note that uncaptured process emissions are not typically considered to be fugitive, and must be accounted for on the appropriate EMISSIONS UNIT DATA SHEET and on the EMISSION POINTS DATA SUMMARY SHEET.

Please note that total emissions from the source are equal to all vented emissions, all fugitive emissions, plus all other emissions (e.g. uncaptured emissions).

APPLICATION FORMS CHECKLIST - FUGITIVE EMISSIONS
1.) Will there be haul road activities? <input checked="" type="checkbox"/> Yes <input type="checkbox"/> No <input checked="" type="checkbox"/> If YES, then complete the HAUL ROAD EMISSIONS UNIT DATA SHEET.
2.) Will there be Storage Piles? <input type="checkbox"/> Yes <input checked="" type="checkbox"/> No <input type="checkbox"/> If YES, complete Table 1 of the NONMETALLIC MINERALS PROCESSING EMISSIONS UNIT DATA SHEET.
3.) Will there be Liquid Loading/Unloading Operations? <input checked="" type="checkbox"/> Yes <input type="checkbox"/> No <input checked="" type="checkbox"/> If YES, complete the BULK LIQUID TRANSFER OPERATIONS EMISSIONS UNIT DATA SHEET.
4.) Will there be emissions of air pollutants from Wastewater Treatment Evaporation? <input type="checkbox"/> Yes <input checked="" type="checkbox"/> No <input type="checkbox"/> If YES, complete the GENERAL EMISSIONS UNIT DATA SHEET.
5.) Will there be Equipment Leaks (e.g. leaks from pumps, compressors, in-line process valves, pressure relief devices, open-ended valves, sampling connections, flanges, agitators, cooling towers, etc.)? <input checked="" type="checkbox"/> Yes <input type="checkbox"/> No <input checked="" type="checkbox"/> If YES, complete the LEAK SOURCE DATA SHEET section of the CHEMICAL PROCESSES EMISSIONS UNIT DATA SHEET.
6.) Will there be General Clean-up VOC Operations? <input type="checkbox"/> Yes <input checked="" type="checkbox"/> No <input type="checkbox"/> If YES, complete the GENERAL EMISSIONS UNIT DATA SHEET.
7.) Will there be any other activities that generate fugitive emissions? <input checked="" type="checkbox"/> Yes <input type="checkbox"/> No <input checked="" type="checkbox"/> If YES, complete the GENERAL EMISSIONS UNIT DATA SHEET or the most appropriate form.
If you answered "NO" to all of the items above, it is not necessary to complete the following table, "Fugitive Emissions Summary."

FUGITIVE EMISSIONS SUMMARY	All Regulated Pollutants - Chemical Name/CAS ¹	Maximum Potential Uncontrolled Emissions ²		Maximum Potential Controlled Emissions ³		Est. Method Used ⁴
		lb/hr	ton/yr	lb/hr	ton/yr	
Haul Road/Road Dust Emissions Paved Haul Roads						
Unpaved Haul Roads	PM-10 PM-2.5	0.30 0.03	1.30 0.13	0.30 0.03	1.30 0.13	EE
Storage Pile Emissions						
Loading/Unloading Operations	VOCs Total HAPs CO2e	57.54 4.53 156.2	7.87 0.62 21.36	57.54 4.53 156.2	7.87 0.62 21.36	EE
Wastewater Treatment Evaporation & Operations						
Equipment Leaks	VOCs Total HAPs CO2e	2.20 0.089 27.53	9.64 0.39 121	2.20 0.089 27.53	9.64 0.39 121	EE
General Clean-up VOC Emissions						
Other – Venting Episodes	VOCs Total HAPs CO2e	Does not apply	18.34 0.39 1,717	Does not apply	18.34 0.39 1,717	EE

¹ List all regulated air pollutants. Speciate VOCs, including all HAPs. Follow chemical name with Chemical Abstracts Service (CAS) number. LIST Acids, CO, CS₂, VOCs, H₂S, Inorganics, Lead, Organics, O₃, NO, NO₂, SO₂, SO₃, all applicable Greenhouse Gases (including CO₂ and methane), etc. DO NOT LIST H₂, H₂O, N₂, O₂, and Noble Gases.

² Give rate with no control equipment operating. If emissions occur for less than 1 hr, then record emissions per batch in minutes (e.g. 5 lb VOC/20 minute batch).

³ Give rate with proposed control equipment operating. If emissions occur for less than 1 hr, then record emissions per batch in minutes (e.g. 5 lb VOC/20 minute batch).

⁴ Indicate method used to determine emission rate as follows: MB = material balance; ST = stack test (give date of test); EE = engineering estimate; O = other (specify).

**Attachment L.
Emission Unit Data Sheets**

Dehydrators

NATURAL GAS GLYCOL DEHYDRATION UNIT DATA SHEET

General Glycol Dehydration Unit Data		Manufacturer and Model		Valerus, 110 MMscfd	
		Max Dry Gas Flow Rate (mmscf/day)		110	
		Design Heat Input (mmBtu/hr)		1.5	
		Design Type (DEG or TEG)		TEG	
		Source Status ²		MS	
		Date Installed/Modified/Removed ³		January 2017	
		Regenerator Still Vent APCD ⁴		FL	
		Fuel HV (Btu/scf)		1214	
		H ₂ S Content (gr/100 scf)		0	
		Operation (hrs/yr)		8,760	
Source ID # ¹	Vent	Reference ⁵	Potential Emissions ⁶	lbs/hr	tons/yr
28E	Reboiler Vent – (includes controlled flash tank emissions)	AP & GLYCalc	NO _x	0.15	0.64
		AP & GLYCalc	CO	0.12	0.54
		AP & GLYCalc	VOC	0.91	3.97
		AP & GLYCalc	SO ₂	0.00088	0.0039
		AP & GLYCalc	PM ₁₀	0.011	0.049
		AP & GLYCalc	Benzene	0.0016	0.0070
		AP & GLYCalc	Ethylbenzene	0.0001	0.0004
		AP & GLYCalc	Toluene	0.0024	0.010
		AP & GLYCalc	Xylenes	0.00020	0.00090
		AP & GLYCalc	n-Hexane	0.019	0.083
29E	Glycol Regenerator Still Vent	GLYCalc	VOC	0.37	1.61
		GLYCalc	Benzene	0.023	0.10
		GLYCalc	Ethylbenzene	0.0031	0.014
		GLYCalc	Toluene	0.051	0.23
		GLYCalc	Xylenes	0.011	0.047
		GLYCalc	n-Hexane	0.011	0.049

General Glycol Dehydration Unit Data		Manufacturer and Model		Valerus, 110 MMscfd	
		Max Dry Gas Flow Rate (mmscf/day)		110	
		Design Heat Input (mmBtu/hr)		1.5	
		Design Type (DEG or TEG)		TEG	
		Source Status ²		MS	
		Date Installed/Modified/Removed ³		January 2017	
		Regenerator Still Vent APCD ⁴		FL	
		Fuel HV (Btu/scf)		1,214	
		H ₂ S Content (gr/100 scf)		0	
		Operation (hrs/yr)		8,760	
Source ID # ¹	Vent	Reference ⁵	Potential Emissions ⁶	lbs/hr	tons/yr
30E	Reboiler Vent – (includes controlled flash tank emissions)	AP & GLYCalc	NO _x	0.15	0.64
		AP & GLYCalc	CO	0.12	0.54
		AP & GLYCalc	VOC	0.91	3.97
		AP & GLYCalc	SO ₂	0.00088	0.0039
		AP & GLYCalc	PM ₁₀	0.011	0.049
		AP & GLYCalc	Benzene	0.0016	0.0070
		AP & GLYCalc	Ethylbenzene	0.0001	0.0004
		AP & GLYCalc	Toluene	0.0024	0.010
		AP & GLYCalc	Xylenes	0.00020	0.00090
		AP & GLYCalc	n-Hexane	0.019	0.083
31E	Glycol Regenerator Still Vent	GLYCalc	VOC	0.37	1.61
		GLYCalc	Benzene	0.023	0.10
		GLYCalc	Ethylbenzene	0.0031	0.014
		GLYCalc	Toluene	0.051	0.23
		GLYCalc	Xylenes	0.011	0.047
		GLYCalc	n-Hexane	0.011	0.049

1. Enter the appropriate Source Identification Numbers for the glycol dehydration unit Reboiler Vent and glycol Regenerator Still Vent. The glycol dehydration unit Reboiler Vent and glycol Regenerator Still Vent should be designated RBV-1 and RSV-1, respectively. If the compressor station incorporates multiple glycol dehydration units, a *Glycol Dehydration Unit Data Sheet* shall be completed for each, using Source Identification #s RBV-2 and RSV-2, RBV-3 and RSV-3, etc.
2. Enter the Source Status using the following codes:

NS	Construction of New Source	ES	Existing Source
MS	Modification of Existing Source	RS	Removal of Source
3. Enter the date (or anticipated date) of the glycol dehydration unit's installation (construction of source), modification or removal.

4. Enter the Air Pollution Control Device (APCD) type designation using the following codes:

NA	None	CD	Condenser
FL	Flare	CC	Condenser/Combustion Combination
TO	Thermal Oxidizer		

5. Enter the Potential Emissions Data Reference designation using the following codes:

MD	Manufacturer's Data	AP	AP-42	
GR	GRI-GLYCalc™	OT	Other _____	(please list)

6. Enter the Reboiler Vent and glycol Regenerator Still Vent Potential to Emit (PTE) for the listed regulated pollutants in lbs per hour and tons per year. The glycol Regenerator Still Vent potential emissions may be determined using the most recent version of the thermodynamic software model GRI-GLYCalc™ (Radian International LLC & Gas Research Institute). Attach all referenced Potential Emissions Data (or calculations) and the GRI-GLYCalc *Aggregate Calculations Report* to this *Glycol Dehydration Unit Data Sheet(s)*. This PTE data shall be incorporated in the *Emissions Summary Sheet*.

Include a copy of the GRI-GLYCalc™ analysis. This includes a printout of the aggregate calculations report, which shall include emissions reports, equipment reports, and stream reports.

***An explanation of input parameters and examples, when using GRI-GLYCalc™ is available on our website.**

West Virginia Department of Environmental Protection

DIVISION OF AIR QUALITY : (304) 926-0475
 WEB PAGE: http://www.wvdep.org

Division of Air Quality

40 CFR Part 63; Subpart HH & HHH Registration Form

Complete this form for any oil and natural gas production or natural gas transmission and storage facility that uses an affected unit under HH/HHH, whether subject or not.

Section A: Facility Description			
Affected facility actual annual average natural gas throughput (scf/day):	220,000,000 (110,000,000 per Dehy)		
Affected facility actual annual average hydrocarbon liquid throughput: (bbl/day):	195.6		
The affected facility processes, upgrades, or stores hydrocarbon liquids prior to custody transfer.	<input checked="" type="radio"/> Yes	No	
The affected facility processes, upgrades, or stores natural gas prior to the point at which natural gas (NG) enters the NG transmission and storage source category or is delivered to the end user.	<input checked="" type="radio"/> Yes	No	
The affected facility is: <input checked="" type="checkbox"/> prior to a NG processing plant <input type="checkbox"/> a NG processing plant <input type="checkbox"/> prior to the point of custody transfer and there is no NG processing plant			
The affected facility transports or stores natural gas prior to entering the pipeline to a local distribution company or to a final end user (if there is no local distribution company).	<input checked="" type="radio"/> Yes	No	
The affected facility exclusively processes, stores, or transfers black oil.	Yes	<input checked="" type="radio"/> No	
Initial producing gas-to-oil ratio (GOR): _____scf/bbl	API gravity: _____degrees		
Section B: Dehydration Unit (if applicable) ¹			
Description: Nichols Compressor Station Dehydrators (RSV-1 and RSV-2)			
Date of Installation: January 2015	Annual Operating Hours: 8,760	Burner rating (MMbtu/hr): 1.5	
Exhaust Stack Height (ft): 15	Stack Diameter (ft): 4	Stack Temp. (°F): 1,400	
Glycol Type: <input checked="" type="checkbox"/> TEG <input type="checkbox"/> EG <input type="checkbox"/> Other:			
Glycol Pump Type: <input type="checkbox"/> Electric <input checked="" type="checkbox"/> Gas	If gas, what is the volume ratio? _0.032_ ACFM/gpm		
Condenser installed? <input checked="" type="checkbox"/> Yes <input type="checkbox"/> No	Exit Temp. 145_ °F	Condenser Pressure _0_ psig	
Incinerator/flare installed? <input checked="" type="checkbox"/> Yes <input type="checkbox"/> No	Destruction Eff. _98_ %		
Other controls installed? <input type="checkbox"/> Yes <input checked="" type="checkbox"/> No	Describe:		
Wet Gas ² : (Upstream of Contact Tower)	Gas Temp.: _120_ °F	Gas Pressure _1200_ psig	Saturated Gas? <input checked="" type="checkbox"/> Yes <input type="checkbox"/> No
	If no, water content _____ lb/MMSCF		
Dry Gas: (Downstream of Contact Tower)	Gas Flowrate(MMSCFD) Actual _____ Design _110_	Water Content _5.0_ lb/MMSCF	
Lean Glycol:	Circulation rate (gpm) Actual ³ _____ Maximum ⁴ _15_	Pump make/model: Kimray 45015PV	
Glycol Flash Tank (if applicable):	Temp.: _130_ °F	Pressure _60_ psig	Vented? Yes <input type="checkbox"/> No <input checked="" type="checkbox"/>
	If no, describe vapor control: Flash tank vent gas used in reboiler as fuel or sent to VRU system		
Stripping Gas (if applicable):	Source of gas: dry gas, if used	Rate _9_ scfm	

Please attach the following required dehydration unit information:

1. System map indicating the chain of custody information. See Page 43 of this document for an example of a gas flow schematic. It is not intended that the applicant provide this level of detail for all sources. The level of detail that is necessary is to establish where the custody transfer points are located. This can be accomplished by submitting a process flow diagram indicating custody transfer points and the natural gas flow. However, the DAQ reserves the right to request more detailed information in order to make the necessary decisions.
2. Extended gas analysis from the Wet Gas Stream including mole percents of C₁-C₈, benzene, ethylbenzene, toluene, xylene and n-Hexane, using Gas Processors Association (GPA) 2286 (or similar). A sample should be taken from the inlet gas line, downstream from any inlet separator, and using a manifold to remove entrained liquids from the sample and a probe to collect the sample from the center of the gas line. GPA standard 2166 reference method or a modified version of EPA Method TO-14, (or similar) should be used.
3. GRI-GLYCalc Ver. 3.0 aggregate report based on maximum Lean Glycol circulation rate and maximum throughput.
4. Detailed calculations of gas or hydrocarbon flow rate.

Section C: Facility NESHAPS Subpart HH/HHH status

	<input checked="" type="checkbox"/> Subject to Subpart HH - applies, but is exempt through < 1 tpy benzene exemption	
Affected facility	<input type="checkbox"/> Subject to Subpart HHH	
status:	<input checked="" type="checkbox"/> Not Subject	<input checked="" type="checkbox"/> < 10/25 TPY
(choose only one)	because:	<input type="checkbox"/> Affected facility exclusively handles black oil <input type="checkbox"/> The facility wide actual annual average NG throughput is < 650 thousand scf/day and facility wide actual annual average hydrocarbon liquid is < 250 bpd <input type="checkbox"/> No affected source is present

Fuel Conditioning Heaters

Attachment L
EMISSIONS UNIT DATA SHEET
GENERAL

To be used for affected sources other than asphalt plants, foundries, incinerators, indirect heat exchangers, and quarries.

Identification Number (as assigned on *Equipment List Form*): 52E

1. Name or type and model of proposed affected source:

Fuel Conditioning Heater - 500,000 Btu/hr

2. On a separate sheet(s), furnish a sketch(es) of this affected source. If a modification is to be made to this source, clearly indicated the change(s). Provide a narrative description of all features of the affected source which may affect the production of air pollutants.

3. Name(s) and maximum amount of proposed process material(s) charged per hour:

Natural Gas as fuel - 490 scf/hr

4. Name(s) and maximum amount of proposed material(s) produced per hour:

Heater is used to increase temperature of fuel before use by the compressor engines to allow more complete combustion.

5. Give chemical reactions, if applicable, that will be involved in the generation of air pollutants:

Combustion process

* The identification number which appears here must correspond to the air pollution control device identification number appearing on the *List Form*.

6. Combustion Data (if applicable):

(a) Type and amount in appropriate units of fuel(s) to be burned:

Natural gas as fuel - 490 scf/hr

(b) Chemical analysis of proposed fuel(s), excluding coal, including maximum percent sulfur and ash:

Same as onsite gas analysis - see Attachment N

(c) Theoretical combustion air requirement (ACF/unit of fuel):

@

°F and

psia.

(d) Percent excess air:

(e) Type and BTU/hr of burners and all other firing equipment planned to be used:

500,000 Btu/hr. Natural gas.

(f) If coal is proposed as a source of fuel, identify supplier and seams and give sizing of the coal as it will be fired:

(g) Proposed maximum design heat input:

× 10⁶ BTU/hr.

7. Projected operating schedule:

Hours/Day

24

Days/Week

7

Weeks/Year

52

8. Projected amount of pollutants that would be emitted from this affected source if no control devices were used:

@	°F and		psia
a. NO _x	0.049	lb/hr	grains/ACF
b. SO ₂	0.00029	lb/hr	grains/ACF
c. CO	0.041	lb/hr	grains/ACF
d. PM ₁₀	0.0037	lb/hr	grains/ACF
e. Hydrocarbons		lb/hr	grains/ACF
f. VOCs	0.0027	lb/hr	grains/ACF
g. Pb		lb/hr	grains/ACF
h. Specify other(s)			
Total HAP (including HCHO)	0.00092	lb/hr	grains/ACF
CO _{2e}	58.7	lb/hr	grains/ACF
		lb/hr	grains/ACF
		lb/hr	grains/ACF

NOTE: (1) An Air Pollution Control Device Sheet must be completed for any air pollution device(s) used to control emissions from this affected source.

(2) Complete the Emission Points Data Sheet.

9. Proposed Monitoring, Recordkeeping, Reporting, and Testing
Please propose monitoring, recordkeeping, and reporting in order to demonstrate compliance with the proposed operating parameters. Please propose testing in order to demonstrate compliance with the proposed emissions limits.

MONITORING
see Attachment O

RECORDKEEPING
see Attachment O

REPORTING
see Attachment O

TESTING
see Attachment O

MONITORING. PLEASE LIST AND DESCRIBE THE PROCESS PARAMETERS AND RANGES THAT ARE PROPOSED TO BE MONITORED IN ORDER TO DEMONSTRATE COMPLIANCE WITH THE OPERATION OF THIS PROCESS EQUIPMENT OPERATION/AIR POLLUTION CONTROL DEVICE.

RECORDKEEPING. PLEASE DESCRIBE THE PROPOSED RECORDKEEPING THAT WILL ACCOMPANY THE MONITORING.

REPORTING. PLEASE DESCRIBE THE PROPOSED FREQUENCY OF REPORTING OF THE RECORDKEEPING.

TESTING. PLEASE DESCRIBE ANY PROPOSED EMISSIONS TESTING FOR THIS PROCESS EQUIPMENT/AIR POLLUTION CONTROL DEVICE.

10. Describe all operating ranges and maintenance procedures required by Manufacturer to maintain warranty

Settling Tank

Attachment L EMISSIONS UNIT DATA SHEET STORAGE TANKS

Provide the following information for each new or modified bulk liquid storage tank as shown on the *Equipment List Form* and other parts of this application. A tank is considered modified if the material to be stored in the tank is different from the existing stored liquid.

IF USING US EPA'S TANKS EMISSION ESTIMATION PROGRAM (AVAILABLE AT www.epa.gov/tnn/tanks.html), APPLICANT MAY ATTACH THE SUMMARY SHEETS IN LIEU OF COMPLETING SECTIONS III, IV, & V OF THIS FORM. HOWEVER, SECTIONS I, II, AND VI OF THIS FORM MUST BE COMPLETED. US EPA'S AP-42, SECTION 7.1, "ORGANIC LIQUID STORAGE TANKS," MAY ALSO BE USED TO ESTIMATE VOC AND HAP EMISSIONS (<http://www.epa.gov/tnn/chief/>).

I. GENERAL INFORMATION (required)

1. Bulk Storage Area Name Production Storage Tanks	2. Tank Name Settling Tank
3. Tank Equipment Identification No. (as assigned on <i>Equipment List Form</i>) T03	4. Emission Point Identification No. (as assigned on <i>Equipment List Form</i>) 34E
5. Date of Commencement of Construction (for existing tanks)	
6. Type of change <input type="checkbox"/> New Construction <input type="checkbox"/> New Stored Material <input type="checkbox"/> Other Tank Modification	
7. Description of Tank Modification (if applicable) Existing source – update working and breathing emissions for a 500 barrel tank.	
7A. Does the tank have more than one mode of operation? <input type="checkbox"/> Yes <input checked="" type="checkbox"/> No (e.g. Is there more than one product stored in the tank?)	
7B. If YES, explain and identify which mode is covered by this application (Note: A separate form must be completed for each mode).	
7C. Provide any limitations on source operation affecting emissions, any work practice standards (e.g. production variation, etc.): None	

II. TANK INFORMATION (required)

8. Design Capacity (specify barrels or gallons). Use the internal cross-sectional area multiplied by internal height. <div style="text-align: right; margin-right: 50px;">500 barrel</div>	
9A. Tank Internal Diameter (ft) <div style="text-align: center;">12</div>	9B. Tank Internal Height (or Length) (ft) <div style="text-align: center;">25</div>
10A. Maximum Liquid Height (ft) <div style="text-align: center;">24</div>	10B. Average Liquid Height (ft) <div style="text-align: center;">12.5</div>
11A. Maximum Vapor Space Height (ft) <div style="text-align: center;">1</div>	11B. Average Vapor Space Height (ft) <div style="text-align: center;">12.5</div>
12. Nominal Capacity (specify barrels or gallons). This is also known as "working volume" and considers design liquid levels and overflow valve heights. <div style="text-align: right; margin-right: 50px;">475 barrel</div>	

13A. Maximum annual throughput (gal/yr) 2,998,548	13B. Maximum daily throughput (gal/day) 8,215
14. Number of Turnovers per year (annual net throughput/maximum tank liquid volume) 147.68	
15. Maximum tank fill rate (gal/min) TBD	
16. Tank fill method <input type="checkbox"/> Submerged <input checked="" type="checkbox"/> Splash <input type="checkbox"/> Bottom Loading	
17. Complete 17A and 17B for Variable Vapor Space Tank Systems <input checked="" type="checkbox"/> Does Not Apply	
17A. Volume Expansion Capacity of System (gal)	17B. Number of transfers into system per year
18. Type of tank (check all that apply): <input checked="" type="checkbox"/> Fixed Roof <input checked="" type="checkbox"/> vertical <input type="checkbox"/> horizontal <input type="checkbox"/> flat roof <input type="checkbox"/> cone roof <input checked="" type="checkbox"/> dome roof <input type="checkbox"/> other (describe) <input type="checkbox"/> External Floating Roof <input type="checkbox"/> pontoon roof <input type="checkbox"/> double deck roof <input type="checkbox"/> Domed External (or Covered) Floating Roof <input type="checkbox"/> Internal Floating Roof <input type="checkbox"/> vertical column support <input type="checkbox"/> self-supporting <input type="checkbox"/> Variable Vapor Space <input type="checkbox"/> lifter roof <input type="checkbox"/> diaphragm <input type="checkbox"/> Pressurized <input type="checkbox"/> spherical <input type="checkbox"/> cylindrical <input type="checkbox"/> Underground <input type="checkbox"/> Other (describe)	

III. TANK CONSTRUCTION & OPERATION INFORMATION (optional if providing TANKS Summary Sheets)

19. Tank Shell Construction: <input type="checkbox"/> Riveted <input type="checkbox"/> Gunitite lined <input type="checkbox"/> Epoxy-coated rivets <input type="checkbox"/> Other (describe)		
20A. Shell Color	20B. Roof Color	20C. Year Last Painted
21. Shell Condition (if metal and unlined): <input type="checkbox"/> No Rust <input type="checkbox"/> Light Rust <input type="checkbox"/> Dense Rust <input type="checkbox"/> Not applicable		
22A. Is the tank heated? <input type="checkbox"/> YES <input type="checkbox"/> NO		
22B. If YES, provide the operating temperature (°F)		
22C. If YES, please describe how heat is provided to tank.		
23. Operating Pressure Range (psig): _____ to _____		
24. Complete the following section for Vertical Fixed Roof Tanks		<input type="checkbox"/> Does Not Apply
24A. For dome roof, provide roof radius (ft)		
24B. For cone roof, provide slope (ft/ft)		
25. Complete the following section for Floating Roof Tanks		<input type="checkbox"/> Does Not Apply
25A. Year Internal Floaters Installed:		
25B. Primary Seal Type: <input type="checkbox"/> Metallic (Mechanical) Shoe Seal <input type="checkbox"/> Liquid Mounted Resilient Seal <input type="checkbox"/> Vapor Mounted Resilient Seal <input type="checkbox"/> Other (describe):		
25C. Is the Floating Roof equipped with a Secondary Seal? <input type="checkbox"/> YES <input type="checkbox"/> NO		
25D. If YES, how is the secondary seal mounted? (check one) <input type="checkbox"/> Shoe <input type="checkbox"/> Rim <input type="checkbox"/> Other (describe):		
25E. Is the Floating Roof equipped with a weather shield? <input type="checkbox"/> YES <input type="checkbox"/> NO		

25F. Describe deck fittings; indicate the number of each type of fitting:		
ACCESS HATCH		
BOLT COVER, GASKETED:	UNBOLTED COVER, GASKETED:	UNBOLTED COVER, UNGASKETED:
AUTOMATIC GAUGE FLOAT WELL		
BOLT COVER, GASKETED:	UNBOLTED COVER, GASKETED:	UNBOLTED COVER, UNGASKETED:
COLUMN WELL		
BUILT-UP COLUMN – SLIDING COVER, GASKETED:	BUILT-UP COLUMN – SLIDING COVER, UNGASKETED:	PIPE COLUMN – FLEXIBLE FABRIC SLEEVE SEAL:
LADDER WELL		
PIP COLUMN – SLIDING COVER, GASKETED:	PIPE COLUMN – SLIDING COVER, UNGASKETED:	
GAUGE-HATCH/SAMPLE PORT		
SLIDING COVER, GASKETED:	SLIDING COVER, UNGASKETED:	
ROOF LEG OR HANGER WELL		
WEIGHTED MECHANICAL ACTUATION, GASKETED:	WEIGHTED MECHANICAL ACTUATION, UNGASKETED:	SAMPLE WELL-SLIT FABRIC SEAL (10% OPEN AREA)
VACUUM BREAKER		
WEIGHTED MECHANICAL ACTUATION, GASKETED:	WEIGHTED MECHANICAL ACTUATION, UNGASKETED:	
RIM VENT		
WEIGHTED MECHANICAL ACTUATION GASKETED:	WEIGHTED MECHANICAL ACTUATION, UNGASKETED:	
DECK DRAIN (3-INCH DIAMETER)		
OPEN:	90% CLOSED:	
STUB DRAIN		
1-INCH DIAMETER:		
OTHER (DESCRIBE, ATTACH ADDITIONAL PAGES IF NECESSARY)		

26. Complete the following section for Internal Floating Roof Tanks <input type="checkbox"/> Does Not Apply	
26A. Deck Type: <input type="checkbox"/> Bolted <input type="checkbox"/> Welded	
26B. For Bolted decks, provide deck construction:	
26C. Deck seam: <input type="checkbox"/> Continuous sheet construction 5 feet wide <input type="checkbox"/> Continuous sheet construction 6 feet wide <input type="checkbox"/> Continuous sheet construction 7 feet wide <input type="checkbox"/> Continuous sheet construction 5 × 7.5 feet wide <input type="checkbox"/> Continuous sheet construction 5 × 12 feet wide <input type="checkbox"/> Other (describe)	
26D. Deck seam length (ft)	26E. Area of deck (ft ²)
For column supported tanks:	26G. Diameter of each column:
26F. Number of columns:	

IV. SITE INFORMANTION (optional if providing TANKS Summary Sheets)

27. Provide the city and state on which the data in this section are based.
28. Daily Average Ambient Temperature (°F)
29. Annual Average Maximum Temperature (°F)
30. Annual Average Minimum Temperature (°F)
31. Average Wind Speed (miles/hr)
32. Annual Average Solar Insulation Factor (BTU/(ft ² ·day))
33. Atmospheric Pressure (psia)

V. LIQUID INFORMATION (optional if providing TANKS Summary Sheets)

34. Average daily temperature range of bulk liquid:			
34A. Minimum (°F)		34B. Maximum (°F)	
35. Average operating pressure range of tank:			
35A. Minimum (psig)		35B. Maximum (psig)	
36A. Minimum Liquid Surface Temperature (°F)		36B. Corresponding Vapor Pressure (psia)	
37A. Average Liquid Surface Temperature (°F)		37B. Corresponding Vapor Pressure (psia)	
38A. Maximum Liquid Surface Temperature (°F)		38B. Corresponding Vapor Pressure (psia)	
39. Provide the following for <u>each</u> liquid or gas to be stored in tank. Add additional pages if necessary.			
39A. Material Name or Composition			
39B. CAS Number			
39C. Liquid Density (lb/gal)			
39D. Liquid Molecular Weight (lb/lb-mole)			
39E. Vapor Molecular Weight (lb/lb-mole)			

Maximum Vapor Pressure 39F. True (psia)			
39G. Reid (psia)			
Months Storage per Year 39H. From			
39I. To			

VI. EMISSIONS AND CONTROL DEVICE DATA (required)

40. Emission Control Devices (check as many as apply): Does Not Apply

- Carbon Adsorption¹
- Condenser¹
- Conservation Vent (psig)

Vacuum Setting	Pressure Setting
----------------	------------------
- Emergency Relief Valve (psig)
- Inert Gas Blanket of
- Insulation of Tank with
- Liquid Absorption (scrubber)¹
- Refrigeration of Tank
- Rupture Disc (psig)
- Vent to Incinerator¹
- Other¹ (describe): Vapor Recovery Unit and vapors recycled back into system

¹ Complete appropriate Air Pollution Control Device Sheet.

41. Expected Emission Rate (submit Test Data or Calculations here or elsewhere in the application).

Material Name & CAS No.	Breathing Loss (lb/hr)	Working Loss		Annual Loss (lb/yr)	Estimation Method ¹
		Amount	Units		
VOC	0.0089	0.028	lb/hr	16,060	O-flashing emissions by ProMax 3.2, EPA – working and breathing by EPA Tanks 4.0.9d
Emissions are controlled values				*Annual Loss includes flash emissions	

¹ EPA = EPA Emission Factor, MB = Material Balance, SS = Similar Source, ST = Similar Source Test, Throughput Data, O = Other (specify)

Remember to attach emissions calculations, including TANKS Summary Sheets if applicable.

Fugitives

**Attachment L
EMISSIONS UNIT DATA SHEET
CHEMICAL PROCESS**

For chemical processes please fill out this sheet and all supplementary forms (see below) that apply. Please check all supplementary forms that have been completed.

- Emergency Vent Summary Sheet*
- Leak Sources Data Sheet*
- Toxicology Data Sheet*
- Reactor Data Sheet*
- Distillation Column Data Sheet*

1. Chemical process area name and equipment ID number (as shown in *Equipment List Form*)
Piping for Entire Facility. Piping not contained in equipment form.

2. Standard Industrial Classification Codes (SICs) for process(es)
4923

3. List raw materials and attach MSDSs
Wet Natural Gas

4. List Products and Maximum Production and attach MSDSs

Description and CAS Number	Maximum Hourly (lb/hr)	Maximum Annual (ton/year)
Dry Natural Gas	9.2 MMscf/hour	80,300 MMscf/year
Condensate	6.3 barrels/hour	55,079 barrels/year
Produced Water	1.9 barrels/hour	16,316 barrels/year

5. Complete the *Emergency Vent Summary Sheet* for all emergency relief devices.

6. Complete the *Leak Source Data Sheet* and describe below or attach to application the leak detection or maintenance program to minimize fugitive emissions. Include detection instruments, calibration gases or methods, planned inspection frequency, and record-keeping, and similar pertinent information. If subject to a rule requirement (e.g. 40CFR60, Subpart VV), please list those here.

Leak Detection Plan will be developed. Subject to NSPS OOOOa

7. Clearly describe below or attach to application Accident Procedures to be followed in the event of an accidental spill or release.

Will reference developed and approved Spill Prevention, Control and Countermeasure (SPCC) plan.

8A. Complete the *Toxicology Data Sheet* or attach to application a toxicology report (an up-to-date material safety data sheets (MSDS) may be used) outlining the currently known acute and chronic health effects of each compound or chemical entity emitted to the air. If these compounds have already been listed in Item 3, then a duplicate MSDS sheet is not required. Include data such as the OSHA time weighted average (TWA) or mutagenicity, teratogenicity, irritation, and other known or suspected effects should be addressed. Indicate where these are unknown, and provide references.

8B. Describe any health effects testing or epidemiological studies on these compounds that are being or may be conducted by the company or required under TSCA, RCRA or other federal regulations. Discuss the persistence in the environment of any emission (e.g. pesticides, etc.).

9. **Waste Products** - Waste products status: (If source is subject to RCRA or 45CSR25, please contact the Hazardous Waste Section of WVDEP, OAQ at (304) 926-3647.)

9A. Types and amounts of wastes to be disposed:

9B. Method of disposal and location of waste disposal facilities:

Carrier:

Phone:

9C. Check here if approved USEPA/State Hazardous Waste Landfill will be used

10. Maximum and Projected Typical Operating Schedule for process or project as a whole (circle appropriate units).

circle units:	(hrs/day)	(hr/batch)	(days)	(batches/day), (batches/week)	(days/yr), (weeks/year)
10A. Maximum	24		7		52
10B. Typical	24		7		52

11. Complete a *Reactor Data Sheet* for each reactor in this chemical process.

12. Complete a *Distillation Column Data Sheet* for each distillation column in this chemical process.

13. Proposed Monitoring, Recordkeeping, Reporting, and Testing

Please propose monitoring, recordkeeping, and reporting in order to demonstrate compliance with the proposed operating parameters. Please propose testing in order to demonstrate compliance with the proposed emissions limits.

MONITORING

See Attachment O

RECORDKEEPING

See Attachment O

REPORTING

See Attachment O

TESTING

See Attachment O

MONITORING. Please list and describe the process parameters and ranges that are proposed to be monitored in order to demonstrate compliance with the operation of this process equipment operation or air pollution control device.

RECORDKEEPING. Please describe the proposed recordkeeping that will accompany the monitoring.

REPORTING. Please describe the proposed frequency of reporting of the recordkeeping.

TESTING. Please describe any proposed emissions testing for this process equipment or air pollution control device.

14. Describe all operating ranges and maintenance procedures required by Manufacturer to maintain warranty

LEAK SOURCE DATA SHEET

Source Category	Pollutant	Number of Source Components ¹	Number of Components Monitored by Frequency ²	Average Time to Repair (days) ³	Estimated Annual Emission Rate (lb/yr) ⁴
Pumps ⁵	light liquid VOC ^{6,7}				
	heavy liquid VOC ⁸				
	Non-VOC ⁹				
Valves ¹⁰	Gas VOC	750		1 st attempt – 5 days	10,814 – EE
	Light Liquid VOC	160		1 st attempt – 5 days	5,673 - EE
	Heavy Liquid VOC				
	Non-VOC				
Safety Relief Valves ¹¹	Gas VOC				
	Non VOC				
Open-ended Lines ¹²	VOC				
	Non-VOC				
Sampling Connections ¹³	VOC				
	Non-VOC				
Compressors	VOC	39		1 st attempt – 5 days	1,100 – EE
	Non-VOC				
Flanges	Gas VOC	850		1 st attempt – 5 days	1,062 – EE
	Light Liquid VOC	400		1 st attempt – 5 days	624 – EE
Other	VOC				
	Non-VOC				

^{1 - 13} See notes on the following page.

Attachment L
EMISSIONS UNIT DATA SHEET
GENERAL

To be used for affected sources other than asphalt plants, foundries, incinerators, indirect heat exchangers, and quarries.

Identification Number (as assigned on *Equipment List Form*): Fugitive so no number assigned (VENT1)

1. Name or type and model of proposed affected source:

Fugitive emissions from venting episodes such as plant shutdowns and compressor start/shut downs.

2. On a separate sheet(s), furnish a sketch(es) of this affected source. If a modification is to be made to this source, clearly indicated the change(s). Provide a narrative description of all features of the affected source which may affect the production of air pollutants.

3. Name(s) and maximum amount of proposed process material(s) charged per hour:

4. Name(s) and maximum amount of proposed material(s) produced per hour:

- compressor blowdown - 0.010 tons VOC per event, 0.0002 tons HAPs per event, 0.94 tons CO₂e per event
- compressor startup - 0.005 tons VOC per event, 0.0001 tons HAPs per event, 0.44 tons CO₂e per event
- plant shutdown - 0.45 tons VOC per event, 0.0092 tons HAPs per event, 41.81 tons CO₂e per event
- low pressure pigging venting - 0.002 tons VOC per event, 0.0001 tons HAPs per event, 0.22 tons CO₂e per event
- high pressure pigging venting - 0.013 tons VOC per event, 0.0003 tons HAPs per event, 1.17 tons CO₂e per event

5. Give chemical reactions, if applicable, that will be involved in the generation of air pollutants:

none

* The identification number which appears here must correspond to the air pollution control device identification number appearing on the *List Form*.

6. Combustion Data (if applicable):					
(a) Type and amount in appropriate units of fuel(s) to be burned:					
(b) Chemical analysis of proposed fuel(s), excluding coal, including maximum percent sulfur and ash:					
(c) Theoretical combustion air requirement (ACF/unit of fuel):					
@		°F and		psia.	
(d) Percent excess air:					
(e) Type and BTU/hr of burners and all other firing equipment planned to be used:					
(f) If coal is proposed as a source of fuel, identify supplier and seams and give sizing of the coal as it will be fired:					
(g) Proposed maximum design heat input:					$\times 10^6$ BTU/hr.
7. Projected operating schedule:					
Hours/Day	not a regular schedule	Days/Week	not a regular schedule	Weeks/Year	not a regular schedule

8. Projected amount of pollutants that would be emitted from this affected source if no control devices were used:

		@	venting events are uncontrolled	°F and	psia
a.	NO _x			lb/hr	grains/ACF
b.	SO ₂			lb/hr	grains/ACF
c.	CO			lb/hr	grains/ACF
d.	PM ₁₀			lb/hr	grains/ACF
e.	Hydrocarbons			lb/hr	grains/ACF
f.	VOCs			lb/hr	grains/ACF
g.	Pb			lb/hr	grains/ACF
h.	Specify other(s)			lb/hr	grains/ACF
				lb/hr	grains/ACF
				lb/hr	grains/ACF
				lb/hr	grains/ACF
				lb/hr	grains/ACF

NOTE: (1) An Air Pollution Control Device Sheet must be completed for any air pollution device(s) used to control emissions from this affected source.

(2) Complete the Emission Points Data Sheet.

9. Proposed Monitoring, Recordkeeping, Reporting, and Testing
Please propose monitoring, recordkeeping, and reporting in order to demonstrate compliance with the proposed operating parameters. Please propose testing in order to demonstrate compliance with the proposed emissions limits.

MONITORING

See Attachment O

RECORDKEEPING

See Attachment O

REPORTING

See Attachment O

TESTING

See Attachment O

MONITORING. PLEASE LIST AND DESCRIBE THE PROCESS PARAMETERS AND RANGES THAT ARE PROPOSED TO BE MONITORED IN ORDER TO DEMONSTRATE COMPLIANCE WITH THE OPERATION OF THIS PROCESS EQUIPMENT OPERATION/AIR POLLUTION CONTROL DEVICE.

RECORDKEEPING. PLEASE DESCRIBE THE PROPOSED RECORDKEEPING THAT WILL ACCOMPANY THE MONITORING.

REPORTING. PLEASE DESCRIBE THE PROPOSED FREQUENCY OF REPORTING OF THE RECORDKEEPING.

TESTING. PLEASE DESCRIBE ANY PROPOSED EMISSIONS TESTING FOR THIS PROCESS EQUIPMENT/AIR POLLUTION CONTROL DEVICE.

10. Describe all operating ranges and maintenance procedures required by Manufacturer to maintain warranty
N/A

**Attachment N.
Supporting Emissions Calculations**

Emission Calculations

EMISSIONS SUMMARY TOTAL

Company:	Antero Midstream LLC
Facility Name:	Nichols Compressor Station
Facility Location:	Doddridge County, West Virginia

UNCONTROLLED POTENTIAL EMISSION SUMMARY

Source	NOx		CO		VOC		SO ₂		PM-10		HAPs		Formaldehyde		CO ₂ e tpy
	lb/hr	tpy	lb/hr	tpy	lb/hr	tpy	lb/hr	tpy	lb/hr	tpy	lb/hr	tpy	lb/hr	tpy	
<u>Engines</u>															
Compressor Engine 1	50.37	220.62	47.41	207.64	1.48	6.49	0.0082	0.036	0.27	1.18	0.35	1.54	0.19	0.81	9,133
Compressor Engine 2	50.37	220.62	47.41	207.64	1.48	6.49	0.0082	0.036	0.27	1.18	0.35	1.54	0.19	0.81	9,133
Compressor Engine 3	50.37	220.62	47.41	207.64	1.48	6.49	0.0082	0.036	0.27	1.18	0.35	1.54	0.19	0.81	9,133
Compressor Engine 4	50.37	220.62	47.41	207.64	1.48	6.49	0.0082	0.036	0.27	1.18	0.35	1.54	0.19	0.81	9,133
Compressor Engine 5	50.37	220.62	47.41	207.64	1.48	6.49	0.0082	0.036	0.27	1.18	0.35	1.54	0.19	0.81	9,133
Compressor Engine 6	50.37	220.62	47.41	207.64	1.48	6.49	0.0082	0.036	0.27	1.18	0.35	1.54	0.19	0.81	9,133
Compressor Engine 7	50.37	220.62	47.41	207.64	1.48	6.49	0.0082	0.036	0.27	1.18	0.35	1.54	0.19	0.81	9,133
Compressor Engine 8	50.37	220.62	47.41	207.64	1.48	6.49	0.0082	0.036	0.27	1.18	0.35	1.54	0.19	0.81	9,133
Compressor Engine 9	50.37	220.62	47.41	207.64	1.48	6.49	0.0082	0.036	0.27	1.18	0.35	1.54	0.19	0.81	9,133
Compressor Engine 10	50.37	220.62	47.41	207.64	1.48	6.49	0.0082	0.036	0.27	1.18	0.35	1.54	0.19	0.81	9,133
Compressor Engine 11	50.37	220.62	47.41	207.64	1.48	6.49	0.0082	0.036	0.27	1.18	0.35	1.54	0.19	0.81	9,133
Compressor Engine 12	50.37	220.62	47.41	207.64	1.48	6.49	0.0082	0.036	0.27	1.18	0.35	1.54	0.19	0.81	9,133
Compressor Engine 13	50.37	220.62	47.41	207.64	1.48	6.49	0.0082	0.036	0.27	1.18	0.35	1.54	0.19	0.81	9,133
Fuel Conditioning Heater	0.049	0.21	0.041	0.18	0.0027	0.012	0.00029	0.0013	0.0037	0.016	0.00092	0.0040	0.000037	0.00016	257
<u>Turbines</u>															
Microturbine Generator 1	0.10	0.42	0.26	1.16	0.024	0.11	0.0084	0.037	0.016	0.071	0.0025	0.011	0.0018	0.0077	1,166
Microturbine Generator 2	0.10	0.42	0.26	1.16	0.024	0.11	0.0084	0.037	0.016	0.071	0.0025	0.011	0.0018	0.0077	1,166
Catalytic Heater for Generator Fuel	0.0024	0.010	0.0020	0.0087	0.00013	0.00057	0.000014	0.000062	0.00018	0.00078	0.000044	0.00019	0.0000018	0.0000077	12
<u>Dehydrator</u>															
TEG Dehydrator 1	---	---	---	---	20.76	90.94	---	---	---	---	5.19	22.75	---	---	2,153
TEG Dehydrator 2	---	---	---	---	20.76	90.94	---	---	---	---	5.19	22.75	---	---	2,153
Reboiler 1	0.15	0.64	0.12	0.54	44.95	196.90	0.00088	0.0039	0.011	0.049	1.16	5.09	0.00011	0.00048	13,239
Reboiler 2	0.15	0.64	0.12	0.54	44.95	196.90	0.00088	0.0039	0.011	0.049	1.16	5.09	0.00011	0.00048	13,239
<u>Combustors</u>															
Combustor and Pilot	---	---	---	---	---	---	---	---	---	---	---	---	---	---	---
<u>Hydrocarbon Loading</u>															
Truck Loadout	---	---	---	---	57.54	7.87	---	---	---	---	4.53	0.62	---	---	21
<u>Fugitive Emissions</u>															
Component Leak Emissions	---	---	---	---	2.20	9.64	---	---	---	---	0.089	0.39	---	---	121
Venting Emissions	---	---	---	---	---	18.34	---	---	---	---	---	0.39	---	---	1717
Fugitive Dust Emissions	---	---	---	---	---	---	---	---	0.30	1.30	---	---	---	---	---
<u>Storage Tanks</u>															
Produced Water Tanks	---	---	---	---	0.17	0.75	---	---	---	---	0.014	0.059	---	---	2.0
Settler Tank	---	---	---	---	91.66	401.49	---	---	---	---	7.31	32.02	---	---	1,106
Condensate Tanks	---	---	---	---	2.56	11.20	---	---	---	---	0.20	0.88	---	---	30
Total Facility PTE =	655.35	2,870.44	617.11	2,702.96	304.88	1,109.55	0.13	0.55	3.87	16.96	29.41	110.08	2.41	10.56	155,116

Note: TEG Dehydrator Emissions include the uncontrolled still vent emissions, and the Reboiler Emissions include the uncontrolled dehydrator flash tank emissions.

EMISSIONS SUMMARY TOTAL

Company:	Antero Midstream LLC
Facility Name:	Nichols Compressor Station
Facility Location:	Doddridge County, West Virginia

CONTROLLED POTENTIAL EMISSION SUMMARY

Source	NOx		CO		VOC		SO ₂		PM-10		HAPs		Formaldehyde		CO ₂ e
	lb/hr	tpy	lb/hr	tpy	lb/hr	tpy	lb/hr	tpy	lb/hr	tpy	lb/hr	tpy	lb/hr	tpy	tpy
Engines															
Compressor Engine 1	1.26	5.52	1.19	5.19	0.24	1.04	0.0082	0.036	0.27	1.18	0.050	0.22	0.019	0.081	8,727
Compressor Engine 2	1.26	5.52	1.19	5.19	0.24	1.04	0.0082	0.036	0.27	1.18	0.050	0.22	0.019	0.081	8,727
Compressor Engine 3	1.26	5.52	1.19	5.19	0.24	1.04	0.0082	0.036	0.27	1.18	0.050	0.22	0.019	0.081	8,727
Compressor Engine 4	1.26	5.52	1.19	5.19	0.24	1.04	0.0082	0.036	0.27	1.18	0.050	0.22	0.019	0.081	8,727
Compressor Engine 5	1.26	5.52	1.19	5.19	0.24	1.04	0.0082	0.036	0.27	1.18	0.050	0.22	0.019	0.081	8,727
Compressor Engine 6	1.26	5.52	1.19	5.19	0.24	1.04	0.0082	0.036	0.27	1.18	0.050	0.22	0.019	0.081	8,727
Compressor Engine 7	1.26	5.52	1.19	5.19	0.24	1.04	0.0082	0.036	0.27	1.18	0.050	0.22	0.019	0.081	8,727
Compressor Engine 8	1.26	5.52	1.19	5.19	0.24	1.04	0.0082	0.036	0.27	1.18	0.050	0.22	0.019	0.081	8,727
Compressor Engine 9	1.26	5.52	1.19	5.19	0.24	1.04	0.0082	0.036	0.27	1.18	0.050	0.22	0.019	0.081	8,727
Compressor Engine 10	1.26	5.52	1.19	5.19	0.24	1.04	0.0082	0.036	0.27	1.18	0.050	0.22	0.019	0.081	8,727
Compressor Engine 11	1.26	5.52	1.19	5.19	0.24	1.04	0.0082	0.036	0.27	1.18	0.050	0.22	0.019	0.081	8,727
Compressor Engine 12	1.26	5.52	1.19	5.19	0.24	1.04	0.0082	0.036	0.27	1.18	0.050	0.22	0.019	0.081	8,727
Compressor Engine 13	1.26	5.52	1.19	5.19	0.24	1.04	0.0082	0.036	0.27	1.18	0.050	0.22	0.019	0.081	8,727
Fuel Conditioning Heater	0.049	0.21	0.041	0.18	0.0027	0.012	0.00029	0.0013	0.0037	0.016	0.0009	0.004	0.00004	0.0002	257
Turbines															
Microturbine Generator 1	0.10	0.42	0.26	1.16	0.024	0.11	0.0084	0.037	0.016	0.071	0.0025	0.011	0.0018	0.0077	1,166
Microturbine Generator 2	0.10	0.42	0.26	1.16	0.024	0.11	0.0084	0.037	0.016	0.071	0.0025	0.011	0.0018	0.0077	1,166
Catalytic Heater for Generator Fuel	0.0024	0.010	0.0020	0.0087	0.00013	0.00057	0.000014	0.000062	0.00018	0.00078	0.000044	0.00019	0.0000018	0.0000077	12
Dehydrator															
TEG Dehydrator 1	---	---	---	---	---	---	---	---	---	---	---	---	---	---	---
TEG Dehydrator 2	---	---	---	---	---	---	---	---	---	---	---	---	---	---	---
Reboiler 1	0.15	0.64	0.12	0.54	0.91	3.97	0.00088	0.0039	0.011	0.049	0.026	0.11	0.00011	0.00048	1,029
Reboiler 2	0.15	0.64	0.12	0.54	0.91	3.97	0.00088	0.0039	0.011	0.049	0.026	0.11	0.00011	0.00048	1,029
Combustion															
Combustor and Pilot	0.33	1.44	1.78	7.79	0.73	3.21	0.000012	0.000051	0.00015	0.00065	0.20	0.88	---	---	2,568
Hydrocarbon Loading															
Truck Loadout	---	---	---	---	57.54	7.87	---	---	---	---	4.53	0.62	---	---	21
Fugitive Emissions															
Component Leak Emissions	---	---	---	---	2.20	9.64	---	---	---	---	0.089	0.39	---	---	121
Venting Emissions	---	---	---	---	---	18.34	---	---	---	---	---	0.39	---	---	1,717
Fugitive Dust Emissions	---	---	---	---	---	---	---	---	0.30	1.30	---	---	---	---	---
Storage Tanks															
Produced Water Tanks	---	---	---	---	0.0034	0.015	---	---	---	---	0.00027	0.0012	---	---	0.041
Settler Tank	---	---	---	---	1.83	8.03	---	---	---	---	0.15	0.64	---	---	23
Condensate Tanks	---	---	---	---	0.051	0.22	---	---	---	---	0.0040	0.018	---	---	0.6
Total Facility PTE =	17.24	75.49	18.00	78.85	67.31	68.99	0.13	0.55	3.87	16.96	5.67	6.04	0.24	1.07	122,567

Note: Controlled TEG Dehydrator still vent emissions are included in the Combustor category, and controlled TEG Dehydrator flash tank emissions are included in the Reboiler category.

HAP Emissions Summary Total

Company:	Antero Midstream LLC
Facility Name:	Nichols Compressor Station
Facility Location:	Doddridge County, West Virginia

CONTROLLED POTENTIAL EMISSION SUMMARY

Source	Benzene		Toluene		Ethylbenzene		Xylenes		n-Hexane	
	lb/hr	tpy	lb/hr	tpy	lb/hr	tpy	lb/hr	tpy	lb/hr	tpy
<i>Engines</i>										
Compressor Engine 1	0.0035	0.015	0.0012	0.0054	0.000055	0.00024	0.00043	0.0019	---	---
Compressor Engine 2	0.0035	0.015	0.0012	0.0054	0.000055	0.00024	0.00043	0.0019	---	---
Compressor Engine 3	0.0035	0.015	0.0012	0.0054	0.000055	0.00024	0.00043	0.0019	---	---
Compressor Engine 4	0.0035	0.015	0.0012	0.0054	0.000055	0.00024	0.00043	0.0019	---	---
Compressor Engine 5	0.0035	0.015	0.0012	0.0054	0.000055	0.00024	0.00043	0.0019	---	---
Compressor Engine 6	0.0035	0.015	0.0012	0.0054	0.000055	0.00024	0.00043	0.0019	---	---
Compressor Engine 7	0.0035	0.015	0.0012	0.0054	0.000055	0.00024	0.00043	0.0019	---	---
Compressor Engine 8	0.0035	0.015	0.0012	0.0054	0.000055	0.00024	0.00043	0.0019	---	---
Compressor Engine 9	0.0035	0.015	0.0012	0.0054	0.000055	0.00024	0.00043	0.0019	---	---
Compressor Engine 10	0.0035	0.015	0.0012	0.0054	0.000055	0.00024	0.00043	0.0019	---	---
Compressor Engine 11	0.0035	0.015	0.0012	0.0054	0.000055	0.00024	0.00043	0.0019	---	---
Compressor Engine 12	0.0035	0.015	0.0012	0.0054	0.000055	0.00024	0.00043	0.0019	---	---
Compressor Engine 13	0.0035	0.015	0.0012	0.0054	0.000055	0.00024	0.00043	0.0019	---	---
Fuel Conditioning Heater	---	---	---	---	---	---	---	---	---	---
<i>Turbines</i>										
Microturbine Generator 1	0.000030	0.00013	0.00032	0.0014	0.000079	0.00035	0.00016	0.00069	---	---
Microturbine Generator 2	0.000030	0.00013	0.00032	0.0014	0.000079	0.00035	0.00016	0.00069	---	---
Catalytic Heater for Generator Fuel	---	---	---	---	---	---	---	---	---	---
<i>Dehydrator</i>										
TEG Dehydrator 1	---	---	---	---	---	---	---	---	---	---
TEG Dehydrator 2	---	---	---	---	---	---	---	---	---	---
Reboiler 1	0.0016	0.0070	0.0024	0.010	0.00010	0.00040	0.00020	0.00090	0.019	0.083
Reboiler 2	0.0016	0.0070	0.0024	0.010	0.00010	0.00040	0.00020	0.00090	0.019	0.083
<i>Combustors</i>										
Combustor and Pilot	0.047	0.20	0.10	0.45	0.0062	0.027	0.022	0.094	0.023	0.099
<i>Hydrocarbon Loading</i>										
Truck Loadout	0.061	0.0083	0.11	0.015	0.000076	0.000010	0.012	0.0017	4.35	0.59
<i>Fugitive Emissions</i>										
Component Leak Emissions	0.0017	0.0075	0.0030	0.013	0.000095	0.00042	0.00039	0.0017	0.084	0.37
Venting Emissions	---	0.012	---	0.021	---	0.00020	---	0.0029	---	0.35
Fugitive Dust Emissions	---	---	---	---	---	---	---	---	---	---
<i>Storage Tanks</i>										
Produced Water Tanks	3.64E-06	1.60E-05	6.39E-06	2.80E-05	4.56E-09	2.00E-08	7.30E-07	3.20E-06	2.60E-04	1.14E-03
Settler Tank	1.97E-03	8.62E-03	3.45E-03	1.51E-02	2.46E-06	1.08E-05	3.94E-04	1.73E-03	1.40E-01	6.15E-01
Condensate Tanks	5.42E-05	2.37E-04	9.49E-05	4.16E-04	6.78E-08	2.97E-07	1.09E-05	4.75E-05	3.86E-03	1.69E-02
Total Facility PTE =	0.16	0.46	0.24	0.61	0.0075	0.033	0.041	0.13	4.64	2.21

Compressor Engine Emission Calculations

Company:	Antero Midstream LLC
Facility Name:	Nichols Compressor Station
Facility Location:	Doddridge County, West Virginia
Source Description:	Compressor Engines

Source Information-Per Engine

Emission Unit ID:	CE-01 through CE-13	
Engine Make/Model	Waukesha 7044 GSI	
Service	Compression	
Controls - Y or N / Type	Y	NSCR/AFRC
Site Horsepower Rating ¹	1,680	hp
Fuel Consumption (BSFC) ¹	8,295	Btu/(hp-hr)
Heat Rating ²	13.94	MMBtu/hr
Fuel Consumption ^{2,3}	108.27	MMscf/yr
Fuel Consumption ¹	12,360	scf/hr
Fuel Heating Value	1,127	Btu/scf
Operating Hours	8,760	hrs/yr

Notes:

1. Values from Waukesha specification sheet.
2. Calculated values.
3. Annual fuel consumption is 100% of maximum fuel consumption at 100% load.

Potential Emissions per Engine

Pollutant	Uncontrolled					Controlled					Source of Emissions Factors
	Emission Factor		Estimated Emissions			Emission Factor		Estimated Emissions			
	(lb/MMBtu)	(g/bhp-hr)	(lb/hr)	(lb/yr)	(tpy)	(lb/MMBtu)	(g/bhp-hr)	(lb/hr)	(lb/yr)	(tpy)	
NOx ^{1,4}	---	13.6	50.37	---	220.62	---	0.34	1.26	---	5.52	Manufacturer's Specs - uncontrolled, Catalyst Specs - controlled
CO ^{1,4}	---	12.8	47.41	---	207.64	---	0.32	1.19	---	5.19	Manufacturer's Specs - uncontrolled, Catalyst Specs - controlled
VOC ^{1,4}	---	0.40	1.48	---	6.49	---	0.064	0.24	---	1.04	Manufacturer's Specs - uncontrolled, Catalyst Specs - controlled
SO ₂	5.88E-04	---	0.0082	---	0.036	5.88E-04	---	0.0082	---	0.036	AP-42, Chapter 3.2, Table 3.2-3
PM _{2.5} /PM ₁₀	1.94E-02	---	0.27	---	1.18	1.94E-02	---	0.27	---	1.18	AP-42, Chapter 3.2, Table 3.2-3
Total PM	1.94E-02	---	0.27	---	1.18	1.94E-02	---	0.27	---	1.18	AP-42, Chapter 3.2, Table 3.2-3
1,1,2,2-Tetrachloroethane ⁵	2.53E-05	---	0.00035	3.09	0.0015	4.05E-06	---	0.000056	0.49	0.00025	AP-42, Chapter 3.2, Table 3.2-3 - uncontrolled, see Note 5 - controlled
1,3-Butadiene ⁵	6.63E-04	---	0.0092	80.94	0.040	1.06E-04	---	0.0015	12.95	0.0065	AP-42, Chapter 3.2, Table 3.2-3 - uncontrolled, see Note 5 - controlled
Acetaldehyde ⁵	2.79E-03	---	0.039	340.59	0.17	4.46E-04	---	0.0062	54.49	0.027	AP-42, Chapter 3.2, Table 3.2-3 - uncontrolled, see Note 5 - controlled
Acrolein ⁵	2.63E-03	---	0.037	321.06	0.16	4.21E-04	---	0.0059	51.37	0.026	AP-42, Chapter 3.2, Table 3.2-3 - uncontrolled, see Note 5 - controlled
Benzene ⁵	1.58E-03	---	0.022	192.88	0.096	2.53E-04	---	0.0035	30.86	0.015	AP-42, Chapter 3.2, Table 3.2-3 - uncontrolled, see Note 5 - controlled
Ethylbenzene ⁵	2.48E-05	---	0.00035	3.03	0.0015	3.97E-06	---	0.000055	0.48	0.00024	AP-42, Chapter 3.2, Table 3.2-3 - uncontrolled, see Note 5 - controlled
Formaldehyde ^{1,4}	---	0.05	0.19	1,622	0.81	---	0.005	0.019	162.22	0.081	Manufacturer's Specs - uncontrolled, Catalyst Specs - controlled
Methanol ⁵	3.06E-03	---	0.043	373.55	0.19	4.90E-04	---	0.0068	59.77	0.030	AP-42, Chapter 3.2, Table 3.2-3 - uncontrolled, see Note 5 - controlled
Methylene Chloride	4.12E-05	---	0.00057	5.03	0.0025	4.12E-05	---	0.00057	5.03	0.0025	AP-42, Chapter 3.2, Table 3.2-3
PAH	1.41E-04	---	0.0020	17.21	0.0086	1.41E-04	---	0.0020	17.21	0.0086	AP-42, Chapter 3.2, Table 3.2-3
Toluene ⁵	5.58E-04	---	0.0078	68.12	0.034	8.93E-05	---	0.0012	10.90	0.0054	AP-42, Chapter 3.2, Table 3.2-3 - uncontrolled, see Note 5 - controlled
Xylenes ⁵	1.95E-04	---	0.0027	23.80	0.012	3.12E-05	---	0.00043	3.81	0.0019	AP-42, Chapter 3.2, Table 3.2-3 - uncontrolled, see Note 5 - controlled
Other HAPs ²	2.10E-04	---	0.0029	25.61	0.013	2.10E-04	---	0.0029	25.61	0.013	AP-42, Chapter 3.2, Table 3.2-3
Total HAPS			0.35	3,077	1.54			0.050	435	0.22	
Pollutant	Emission Factor		Estimated Emissions			Emission Factor		Estimated Emissions			Source of Emissions Factors
	(kg/MMBtu)	(g/bhp-hr)	(lb/hr)	(lb/yr)	(tpy)	(kg/MMBtu)	(g/bhp-hr)	(lb/hr)	(lb/yr)	(tpy)	
CO ₂ ¹	---	527	1,952	---	8549	---	527	1,952	---	8549	Manufacturer's Specs
CH ₄ ^{1,4}	---	1.43	5.30	---	23.20	---	0.43	1.59	---	6.96	Manufacturer's Specs - uncontrolled, Catalyst Specs - controlled
N ₂ O	0.0001	---	0.0031	---	0.013	0.0001	---	0.0031	---	0.013	40 CFR Part 98, Subpart C, Table C-2
CO ₂ e ²	---	---	2,085	---	9,133	---	---	1,993	---	8,727	40 CFR Part 98, Subpart A, Table A-1

Notes:

4. Due to variable load conditions, the catalyst efficiency may vary. The catalyst efficiencies used in the emissions are typical based on expected operating conditions. The catalyst specification sheet shows typical destruction efficiencies that were used in the calculations. The emission factors shown on the catalyst specification sheet are not site specific, so those will vary; however the efficiencies will be the same.
5. Denoted HAPs are also VOCs and will be controlled by the catalysts by the same reduction efficiency.

Natural Gas Fueled Fuel Conditioning Heater Emissions

Company:	Antero Midstream LLC
Facility Name:	Nichols Compressor Station
Location:	Doddridge County, West Virginia
Source Description:	Fuel Conditioning Heater

Source Information

Emission Unit ID:	FUEL1	
Source Description:	Fuel Conditioning Heater	
Hours of Operation	8,760	hr/yr
Design Heat Rate	0.50	MMBtu/hr
Fuel Heat Value	1,020	Btu/scf
Fuel Use	4.29	MMscf/yr

Emission Calculations per Heater

Pollutant	Emission Factor (lb/MMscf)	Emissions (lb/hr)	Emissions (tpy)	Emission Factor Source
NO _x	100	0.049	0.21	AP-42 Ch. 1.4 Table 1.4-1
CO	84	0.041	0.18	AP-42 Ch. 1.4 Table 1.4-1
VOC	5.5	0.0027	0.012	AP-42 Ch. 1.4 Table 1.4-2
PM ₁₀	7.6	0.0037	0.016	AP-42 Ch. 1.4 Table 1.4-2
SO ₂	0.6	0.00029	0.0013	AP-42 Ch. 1.4 Table 1.4-2
Formaldehyde	0.075	0.000037	0.00016	AP-42 Ch. 1.4 Table 1.4-3
Total HAPs (including HCHO) ¹	1.9	0.00092	0.0040	AP-42 Ch. 1.4 Table 1.4-3
Pollutant	Emission Factor (kg/MMBtu)	Emissions (lb/hr)	Emissions (tpy)	Emission Factor Source
Carbon Dioxide	53.06	58.63	256.8	40 CFR Part 98, Subpart C, Table C-1
Methane	0.001	0.0011	0.0048	40 CFR Part 98, Subpart C, Table C-2
Nitrous Oxide	0.0001	0.00011	0.00048	40 CFR Part 98, Subpart C, Table C-2
CO ₂ e	----	58.69	257.1	40 CFR Part 98, Subpart A, Table A-1

1. Only those HAP pollutants above detection thresholds were included.

Sample Calculations:

$$\text{Fuel Consumption (MMscf/yr)} = \frac{\text{Heater Size (MMBtu/hr)} * \text{Hours of Operation (hrs/yr)}}{\text{Fuel Heat Value (Btu/scf)} * \text{Heater Efficiency}}$$

$$\text{Emissions (tons/yr)} = \frac{\text{Emission Factor (lbs/MMscf)} * \text{Fuel Consumption (MMscf/yr)}}{2,000 \text{ (lbs/ton)}}$$

Microturbine Generator Emission Calculations

Company:	Antero Midstream LLC
Facility Name:	Nichols Compressor Station
Facility Location:	Doddridge County, West Virginia
Source Description:	Microturbine Generators

Source Information

Emission Unit ID:	GEN-1 & GEN-2	
Make/Model	Capstone C200 Standard	
Microturbine Rating	200	kWe
Net Heat Rate	10,300	Btu/kWhe
Heat Input ¹	2.47	MMBtu/hr
Operating Hours	8,760	hrs/yr

Notes:

1) Calculated

Potential Emissions per Generator

Pollutant	Uncontrolled					Controlled					Source of Emissions Factors
	Emission Factor		Estimated Emissions			Emission Factor		Estimated Emissions			
	(lb/MMBtu)	(lb/MWhe)	(lb/hr)	(lb/yr)	(tpy)	(lb/MMBtu)	(lb/MWhe)	(lb/hr)	(lb/yr)	(tpy)	
NOx	---	0.40	0.10	---	0.42	---	0.40	0.10	---	0.42	Manufacturer Specifications
CO	---	1.10	0.26	---	1.16	---	1.10	0.26	---	1.16	Manufacturer Specifications
VOC	---	0.10	0.024	---	0.11	---	0.10	0.024	---	0.11	Manufacturer Specifications
SO ₂	3.40E-03	---	0.0084	---	0.037	3.40E-03	---	0.0084	---	0.037	AP-42, Chapter 3.1, Table 3.1-2a
PM _{2.5} /PM ₁₀	6.60E-03	---	0.016	---	0.071	6.60E-03	---	0.016	---	0.071	AP-42, Chapter 3.1, Table 3.1-2a
1,3-Butadiene	4.30E-07	---	1.06E-06	0.0093	0.0000047	4.30E-07	---	1.06E-06	0.0093	0.0000047	AP-42, Chapter 3.1, Table 3.1-3
Acetaldehyde	4.00E-05	---	9.89E-05	0.87	0.00043	4.00E-05	---	9.89E-05	0.87	0.00043	AP-42, Chapter 3.1, Table 3.1-3
Acrolein	6.40E-06	---	1.58E-05	0.14	0.000069	6.40E-06	---	1.58E-05	0.14	0.000069	AP-42, Chapter 3.1, Table 3.1-3
Benzene	1.20E-05	---	2.97E-05	0.26	0.00013	1.20E-05	---	2.97E-05	0.26	0.00013	AP-42, Chapter 3.1, Table 3.1-3
Ethylbenzene	3.20E-05	---	7.91E-05	0.69	0.00035	3.20E-05	---	7.91E-05	0.69	0.00035	AP-42, Chapter 3.1, Table 3.1-3
Formaldehyde	7.10E-04	---	1.76E-03	15.37	0.0077	7.10E-04	---	1.76E-03	15.37	0.0077	AP-42, Chapter 3.1, Table 3.1-3
Naphthalene	1.30E-06	---	3.21E-06	0.028	0.000014	1.30E-06	---	3.21E-06	0.028	0.000014	AP-42, Chapter 3.1, Table 3.1-3
PAH	2.20E-06	---	5.44E-06	0.048	0.000024	2.20E-06	---	5.44E-06	0.048	0.000024	AP-42, Chapter 3.1, Table 3.1-3
Propylene Oxide	2.90E-05	---	7.17E-05	0.63	0.00031	2.90E-05	---	7.17E-05	0.63	0.00031	AP-42, Chapter 3.1, Table 3.1-3
Toluene	1.30E-04	---	3.21E-04	2.82	0.0014	1.30E-04	---	3.21E-04	2.82	0.0014	AP-42, Chapter 3.1, Table 3.1-3
Xylenes	6.40E-05	---	1.58E-04	1.39	0.00069	6.40E-05	---	1.58E-04	1.39	0.00069	AP-42, Chapter 3.1, Table 3.1-3
Total HAPS			0.0025	22.25	0.011			0.0025	22.25	0.011	
Pollutant	Emission Factor		Estimated Emissions			Emission Factor		Estimated Emissions			Source of Emissions Factors
	(kg/MMBtu)	(lb/MWhe)	(lb/hr)	(lb/yr)	(tpy)	(kg/MMBtu)	(lb/MWhe)	(lb/hr)	(lb/yr)	(tpy)	
CO ₂	---	1,330	266.0	---	1,165	---	1,330	266.0	---	1,165	Manufacturer Specifications
CH ₄	0.001	---	0.0055	---	0.024	0.001	---	0.0055	---	0.024	40 CFR Part 98, Subpart C, Table C-2
N ₂ O	0.0001	---	0.00055	---	0.0024	0.0001	---	0.00055	---	0.0024	40 CFR Part 98, Subpart C, Table C-2
CO ₂ e	---	---	266	---	1,166	---	---	266	---	1,166	40 CFR Part 98, Subpart A, Table A-1, effective January 2014

Example Calculations

lb/hr = (lb/Mwhe) * kWe * (1 MWe/1000 kWe) or (lb/MMBtu) * (MMBtu/hr) or (kg/MMBtu) * (MMBtu/hr) * (2.21 lb/kg)

tpy = (lb/hr) * (hr/yr) * (ton/2000 lb)

Natural Gas Fueled Catalytic Heater Emissions

Company:	Antero Midstream LLC
Facility Name:	Nichols Compressor Station
Location:	Doddridge County, West Virginia
Source Description:	Catalytic Heater for Generator Fuel

Source Information

Emission Unit ID:	CATHT1	
Source Description:	Generator Fuel Heater	
Hours of Operation	8,760	hr/yr
Design Heat Rate	0.024	MMBtu/hr
Fuel Heat Value	1,020	Btu/scf
Fuel Use	0.21	MMscf/yr

Emission Calculations per Reboiler

Pollutant	Emission Factor (lb/MMscf)	Emissions (lb/hr)	Emissions (tpy)	Emission Factor Source
NO _x	100	0.0024	0.010	AP-42 Ch. 1.4 Table 1.4-1
CO	84	0.0020	0.0087	AP-42 Ch. 1.4 Table 1.4-1
VOC	5.5	0.00013	0.00057	AP-42 Ch. 1.4 Table 1.4-2
PM ₁₀	7.6	0.00018	0.00078	AP-42 Ch. 1.4 Table 1.4-2
SO ₂	0.6	0.000014	0.000062	AP-42 Ch. 1.4 Table 1.4-2
Formaldehyde	0.075	0.0000018	0.0000077	AP-42 Ch. 1.4 Table 1.4-3
Total HAPs (including HCHO)	1.9	0.000044	0.00019	AP-42 Ch. 1.4 Table 1.4-3
Pollutant	Emission Factor (kg/MMBtu)	Emissions (lb/hr)	Emissions (tpy)	Emission Factor Source
Carbon Dioxide	53.06	2.81	12.3	40 CFR Part 98, Subpart C, Table C-1
Methane	0.001	0.000053	0.00023	40 CFR Part 98, Subpart C, Table C-2
Nitrous Oxide	0.0001	0.0000053	0.000023	40 CFR Part 98, Subpart C, Table C-2
CO ₂ e	----	2.82	12.3	40 CFR Part 98, Subpart A, Table A-1

Sample Calculations:

$$\text{Fuel Consumption (MMscf/yr)} = \frac{\text{Heater Size (MMBtu/hr)} * \text{Hours of Operation (hrs/yr)}}{\text{Fuel Heat Value (Btu/scf)}}$$

$$\text{Emissions (tons/yr)} = \frac{\text{Emission Factor (lbs/MMscf)} * \text{Fuel Consumption (MMscf/yr)}}{2,000 \text{ (lbs/ton)}}$$

Dehydrator Emissions

Company:	Antero Midstream LLC
Facility Name:	Nichols Compressor Station
Facility Location:	Doddridge County, West Virginia
Source Description:	Dehydrator Units

Potential Emissions per Dehydrator

Pollutant	Emission Unit ID: RSV-1 and RSV-2		Emission Unit ID: RBV-1 and RBV-2	
	Dehydrator Still Vent (lb/hr)	Dehydrator Still Vent (tpy)	Dehydrator Flash Tank (lb/hr)	Dehydrator Flash Tank (tpy)
Uncontrolled Emissions ¹				
VOC	20.76	90.94	44.95	196.86
Total HAPs	5.19	22.75	1.16	5.08
Benzene	1.19	5.22	0.080	0.35
Toluene	2.67	11.71	0.12	0.52
Ethylbenzene	0.17	0.74	0.0044	0.019
Xylenes	0.59	2.58	0.011	0.046
n-Hexane	0.57	2.49	0.95	4.14
Methane	19.64	86.04	113.78	498.35
Carbon Dioxide	0.46	2.01	2.07	9.07
CO ₂ e	491.5	2,153	2,847	12,468
Controlled Emissions ^{2,3}				
VOC	0.37	1.61	0.90	3.94
Total HAPs	0.10	0.44	0.023	0.10
Benzene	0.023	0.10	0.0016	0.0070
Toluene	0.051	0.23	0.0024	0.010
Ethylbenzene	0.0031	0.014	0.00010	0.00040
Xylenes	0.011	0.047	0.00020	0.00090
n-Hexane	0.011	0.049	0.019	0.083
Methane	0.39	1.72	2.28	9.97
Carbon Dioxide	0.46	2.01	2.07	9.07
CO ₂ e	10.28	45.02	58.96	258.24

¹Output from GRI-GLYCalc 4.0 for both the still vent and flash tank gas emissions

²Controlled emissions assume that the glycol still vent is equipped with a condenser and is controlled by a combustor with 98% control efficiency.

³Flash tank gas is used in the reboiler as the primary fuel source. However, in the case that gas cannot be used in the reboiler, the gas is sent to the primary/backup VRU system via the storage tanks for 98% control.

Natural Gas Fueled Dehydrator Reboiler Emissions

Company:	Antero Midstream LLC
Facility Name:	Nichols Compressor Station
Location:	Doddridge County, West Virginia
Source Description:	Dehydrator Reboilers

Source Information

Emission Unit ID:	RBV-1 and RBV-2	
Source Description:	Dehydrator Reboiler	
Hours of Operation	8,760	hr/yr
Design Heat Rate	1.5	MMBtu/hr
Fuel Heat Value	1,020	Btu/scf
Fuel Use	12.9	MMscf/yr

Emission Calculations per Reboiler

Pollutant	Emission Factor (lb/MMscf)	Emissions (lb/hr)	Emissions (tpy)	Emission Factor Source
NO _x	100	0.15	0.64	AP-42 Ch. 1.4 Table 1.4-1
CO	84	0.12	0.54	AP-42 Ch. 1.4 Table 1.4-1
VOC	5.5	0.0081	0.035	AP-42 Ch. 1.4 Table 1.4-2
PM ₁₀	7.6	0.011	0.049	AP-42 Ch. 1.4 Table 1.4-2
SO ₂	0.6	0.00088	0.0039	AP-42 Ch. 1.4 Table 1.4-2
Formaldehyde	0.075	0.00011	0.00048	AP-42 Ch. 1.4 Table 1.4-3
Total HAPs (including HCHO)	1.9	0.0028	0.012	AP-42 Ch. 1.4 Table 1.4-3
Pollutant	Emission Factor (kg/MMBtu)	Emissions (lb/hr)	Emissions (tpy)	Emission Factor Source
Carbon Dioxide	53.06	175.9	770.4	40 CFR Part 98, Subpart C, Table C-1
Methane	0.001	0.0033	0.015	40 CFR Part 98, Subpart C, Table C-2
Nitrous Oxide	0.0001	0.00033	0.0015	40 CFR Part 98, Subpart C, Table C-2
CO ₂ e	----	176.1	771.2	40 CFR Part 98, Subpart A, Table A-1

Sample Calculations:

$$\text{Fuel Consumption (MMscf/yr)} = \frac{\text{Heater Size (MMBtu/hr)} * \text{Hours of Operation (hrs/yr)}}{\text{Fuel Heat Value (Btu/scf)}}$$

$$\text{Emissions (tons/yr)} = \frac{\text{Emission Factor (lbs/MMscf)} * \text{Fuel Consumption (MMscf/yr)}}{2,000 \text{ (lbs/ton)}}$$

Combustor Emissions

Company:	Antero Midstream LLC
Facility Name:	Nichols Compressor Station
Facility Location:	Doddridge County, West Virginia
Source Description:	Combustor for Dehydrator Still Vent Gas
Emission Unit ID:	C-01

Combusted Gas Emissions

Combustor Heat Input :	4.80	MMBtu/hr
Vent Gas to Combustor Rate:	3,955	scf/hr
Gas Heating Value:	1,214	Btu/scf
Hours of Operation:	8,760	hr/yr

Pollutant	Emission Factor ¹ (lb/MMBtu)	Emissions (lbs/hr)	Emissions (tons/yr)
Particulate Matter (PM/PM ₁₀ /PM _{2.5})	N/A - Smokeless Design		
Nitrogen Oxides (NO _x)	0.068	0.33	1.43
Carbon Monoxide (CO)	0.37	1.78	7.78

¹ Emission Factors from Table 13.5-1 of AP-42 Section 13.5 (Sept 1991)

Pilot Emissions

Pilot Heating Value:	1,214	Btu/scf
Hours of Operation:	8,760	hr/yr
Total Pilot Natural Gas Usage:	1.64E-05	MMscf/hr

Pollutant	Emission Factor (lb/MMscf)	Emissions (lbs/hr)	Emissions (tons/yr)
Particulate Matter (PM/PM ₁₀ /PM _{2.5}) ²	7.6	1.48E-04	6.50E-04
Nitrogen Oxides (NO _x) ²	100	1.95E-03	8.55E-03
Sulfur Dioxide (SO ₂) ²	0.6	1.17E-05	5.13E-05
Carbon Monoxide (CO) ²	84	1.64E-03	7.18E-03
Volatile Organic Compounds (VOC) ²	5.5	1.07E-04	4.70E-04
Total HAPs ^{2,3}	1.88	3.67E-05	1.61E-04

² Emission Factors from AP-42 Tables 1.4-1, 1.4-2, 1.4-3, and 1.4-4 (7/98).

³ Sum of Emissions Factors published for pollutants classified as "HAPS" under AP-42 Table 1.4-3.

Total Combustor Emissions

Pollutant	Total Potential Emission Rate (lb/hr)	Total Potential Emission Rate (tons/year)
Particulate Matter (PM/PM ₁₀ /PM _{2.5})	1.48E-04	6.50E-04
Nitrogen Oxides (NO _x)	0.33	1.44
Sulfur Dioxide (SO ₂)	1.17E-05	5.13E-05
Carbon Monoxide (CO)	1.78	7.79
Volatile Organic Compounds (VOC)	1.07E-04	4.70E-04
Total HAPs	3.67E-05	1.61E-04

Greenhouse Gas Emissions

Pollutant	Emission Factor (kg/MMBtu)	Emissions (lb/hr)	Emissions (tpy)	Emission Factor Source
Carbon Dioxide	53.06	565.2	2,476	40 CFR Part 98, Subpart C, Table C-1
Methane	0.001	0.011	0.047	40 CFR Part 98, Subpart C, Table C-2
Nitrogen Dioxide	0.0001	0.0011	0.0047	40 CFR Part 98, Subpart C, Table C-2
CO ₂ e	----	565.8	2,478	40 CFR Part 98, Subpart A, Table A-1

Settling Tank Flashing Emissions

Company:	Antero Midstream LLC
Facility Name:	Nichols Compressor Station
Facility Location:	Doddridge County, West Virginia
Source Description:	Settling Tank Flashing Emissions
Emission Unit ID:	T03

Settling Tank Throughput: **196** bbl/day

Settling Tank Flashing Emissions

Component	Uncontrolled Flashing Emissions ¹ (lb/hr)	Uncontrolled Flashing Emissions (tons/yr)	Controlled Flashing Emissions ² (lb/hr)	Controlled Flashing Emissions ² (tons/yr)
Methane	9.89	43.33	0.20	0.87
Ethane	19.40	84.97	0.39	1.70
Propane	23.77	104.1	0.48	2.08
i-Butane	7.94	34.79	0.16	0.70
n-Butane	17.54	76.84	0.35	1.54
i-Pentane	9.19	40.24	0.18	0.80
n-Pentane	9.99	43.75	0.20	0.88
Hexanes	5.31	23.28	0.11	0.47
Heptanes	5.91	25.88	0.12	0.52
Octanes	2.12	9.27	0.042	0.19
Nonanes	0.014	0.060	0.00028	0.0012
Decanes+	0.87	3.80	0.017	0.076
Benzene	0.096	0.42	0.0019	0.0084
Toluene	0.17	0.74	0.0034	0.015
Ethylbenzene	0.00012	0.00053	0.0000024	0.000011
Xylenes	0.019	0.085	0.00039	0.0017
n-Hexane	6.88	30.13	0.14	0.60
Nitrogen	0.055	0.24	0.055	0.24
Carbon Dioxide	0.20	0.86	0.20	0.86
Water	3.41	14.92	3.41	14.92
VOC Subtotal	89.82	393.4	1.80	7.87
HAP Subtotal	7.16	31.38	0.14	0.63
CO₂e Subtotal	247.5	1,084	5.14	22.52
Total	122.8	537.7	6.04	26.45

Notes:

1. Flashing emissions calculated by ProMax 3.2 Stream "43". Flashing only occurs in the settling tank as all pressurized fluids flow into the settling tank and then separate out at atmospheric conditions to the condensate and produced water tanks.
2. Tanks are controlled by a VRU with assumed 98% capture efficiency; but will likely be higher as vapors are recycled back into the system

Storage Tank Working and Breathing Emissions

Company:	Antero Midstream LLC
Facility Name:	Nichols Compressor Station
Facility Location:	Doddridge County, West Virginia
Source Description:	W&B Storage Tank Emissions
Emission Unit ID:	T01 through T05

TANK DESCRIPTION	Uncontrolled VOC Emissions ¹ (tons/yr)	Uncontrolled Benzene Emissions ⁴ (tons/yr)	Uncontrolled Toluene Emissions ⁴ (tons/yr)	Uncontrolled Ethylbenzene Emissions ⁴ (tons/yr)	Uncontrolled Xylene Emissions ⁴ (tons/yr)	Uncontrolled n-Hexane Emissions ⁴ (tons/yr)	Uncontrolled CH ₄ Emissions ³ (tons/yr)	Uncontrolled CO ₂ e Emissions (tons/yr)
400 bbl Hydrocarbon Storage Tank (T04)	5.60	0.0059	0.010	0.0000074	0.0012	0.42	0.61	15.20
400 bbl Hydrocarbon Storage Tank (T05)	5.60	0.0059	0.010	0.0000074	0.0012	0.42	0.61	15.20
500 bbl Settling Tank (T03)	8.07	0.0085	0.015	0.000011	0.0017	0.61	0.88	21.92
400 bbl Produced Water Storage Tank ² (T01)	0.38	0.00040	0.00070	0.00000050	0.000080	0.028	0.041	1.02
400 bbl Produced Water Storage Tank ² (T02)	0.38	0.00040	0.00070	0.00000050	0.000080	0.028	0.041	1.02
TOTAL	20.03	0.021	0.037	0.000027	0.0043	1.51	2.17	54.37

TANK DESCRIPTION	Controlled VOC Emissions ⁵ (tons/yr)	Controlled Benzene Emissions ⁵ (tons/yr)	Controlled Toluene Emissions ⁵ (tons/yr)	Controlled Ethylbenzene Emissions ⁵ (tons/yr)	Controlled Xylene Emissions ⁵ (tons/yr)	Controlled n-Hexane Emissions ⁵ (tons/yr)	Controlled CH ₄ Emissions ⁵ (tons/yr)	Controlled CO ₂ e Emissions ⁵ (tons/yr)
400 bbl Hydrocarbon Storage Tank (T04)	0.11	1.19E-04	2.08E-04	1.49E-07	2.38E-05	8.46E-03	0.012	0.30
400 bbl Hydrocarbon Storage Tank (T05)	0.11	1.19E-04	2.08E-04	1.49E-07	2.38E-05	8.46E-03	0.012	0.30
500 bbl Settling Tank (T03)	0.16	1.71E-04	3.00E-04	2.14E-07	3.43E-05	1.22E-02	0.018	0.44
400 bbl Produced Water Storage Tank ² (T01)	0.0075	7.98E-06	1.40E-05	9.99E-09	1.60E-06	5.69E-04	0.00082	0.020
400 bbl Produced Water Storage Tank ² (T02)	0.0075	7.98E-06	1.40E-05	9.99E-09	1.60E-06	5.69E-04	0.00082	0.020
TOTAL	0.40	4.24E-04	7.43E-04	5.31E-07	8.50E-05	3.03E-02	0.043	1.09

Notes:

1. EPA Tanks 4.0.9d used to calculate standing, working, and breathing (S,W,B) emissions. Model was run on a per tank basis so as to not underestimate emissions.
2. Produced water assumed to have no more than 10% hydrocarbon liquid
3. Methane emissions estimated assuming 73% VOC and 8% CH₄ in tank vent gas based on ProMax 3.2 simulation.
4. HAP emissions estimated assuming 73% VOC and 5.8% HAPs in the tank vent gas based on ProMax 3.2 simulation.
5. Tanks are controlled by a VRU with assumed 98% capture efficiency; but will likely be higher as vapors are recycled back into the system.

Truck Loading Emissions

Company:	Antero Midstream LLC
Facility Name:	Nichols Compressor Station
Facility Location:	Doddridge County, West Virginia
Source Description:	Production Liquids Truck Loadout
Emission Unit ID:	EPLOR

AP - 42, Chapter 5.2 $L_L = 12.46 \times S \times P \times M / T$

- L_L = Loading Loss Emission Factor (lbs VOC/1000 gal loaded)
 S = Saturation Factor
 P = True Vapor Pressure of the Loaded Liquid (psia)
 M = Vapor Molecular Weight of the Loaded Liquid (lbs/lbmol)
 T = Temperature of Loaded Liquid (°R)

$$\text{VOC Emissions (tpy)} = \frac{L_L (\text{lbs VOC}/1000 \text{ gal}) * 42 \text{ gal}/\text{bbl} * 365 \text{ days}/\text{year} * \text{production (bbl}/\text{day})}{1000 \text{ gal} * 2000 \text{ lbs}/\text{ton}}$$

Source	S ¹	P (psia) ²	M ²	T (°F) ³	T (°R)	L _L (lb/1000 gal)	Production (bbl/day)	Uncontrolled						
								VOC (tpy)	Benzene ⁵ (tpy)	Toluene ⁵ (tpy)	E-Benzene ⁵ (tpy)	Xylene ⁵ (tpy)	n-Hexane ⁵ (tpy)	CO ₂ e ⁶ (tpy)
Condensate	0.6	7.7	60	52	511.81	6.78	151	7.85	0.0083	0.015	0.000010	0.0017	0.59	21.30
Produced Water ⁴	0.6	7.7	60	52	511.81	0.68	45	0.023	2.48E-05	4.34E-05	3.10E-08	4.96E-06	1.77E-03	0.064

- Notes:
- Saturation factor from AP-42, Table 5.2-1 (Submerged loading (bottom loading): dedicated normal service)
 - True vapor pressure and molecular weight retrieved from EPA Tanks 4.0.9d runs.
 - Temperature based on the annual average temperature for Elkins, West Virginia (EPA Tanks 4.0.9d runs).
 - Produced water assumed to have no more than 10% hydrocarbon liquid.
 - HAP emissions estimated from HAP weight% to VOC weight % ratio from settling tank flash gas.
 - CO₂e emissions estimated from CH₄ weight % to VOC weight % ratio from settling tank flash gas.

Assume 1 truck loaded per hour, 200 bbl truck, for short term emissions

Source	S ¹	P (psia) ²	M ²	T (°F) ³	T (°R)	L _L (lb/1000 gal)	Loading bbl/hr	Uncontrolled						
								VOC (lb/hr)	Benzene ⁵ (lb/hr)	Toluene ⁵ (lb/hr)	E-Benzene ⁵ (lb/hr)	Xylene ⁵ (lb/hr)	n-Hexane ⁵ (lb/hr)	CO ₂ e ⁶ (lb/hr)
Condensate	0.6	7.7	60	52	511.81	6.78	200	56.97	0.060	0.11	0.000076	0.012	4.30	154.7
Produced Water ⁴	0.6	7.7	60	52	511.81	0.68	200	0.57	6.03E-04	1.06E-03	7.55E-07	1.21E-04	4.30E-02	1.55

Component Fugitive Emissions

Company:	Antero Midstream LLC
Facility Name:	Nichols Compressor Station
Facility Location:	Doddridge County, West Virginia
Source Description:	Fugitive Emissions-Component Leaks

VOC Fugitive Emissions						
Equipment Type and Service	Number of Units ¹	Hours of Operation (hours/yr)	THC Emission Factor ² (kg/hr-unit)	VOC Weight Fraction ³	THC Emissions (tpy)	VOC Emissions (tpy)
Flanges - Gas Service	850	8,760	3.90E-04	0.17	3.20	0.53
Valves - Gas Service	750	8,760	4.50E-03	0.17	32.59	5.41
Compressor Seals - Gas Service	39	8,760	8.80E-03	0.17	3.31	0.55
Flanges - Liquid Service	400	8,760	1.10E-04	0.73	0.42	0.31
Valves - Liquid Service	160	8,760	2.50E-03	0.73	3.86	2.84
Total Emissions (tons/yr)					43.39	9.64

HAPs Fugitive Emissions										
Equipment Type and Service	Benzene Weight Fraction ³	Benzene Emissions (tpy)	Toluene Weight Fraction ³	Toluene Emissions (tpy)	Ethylbenzene Weight Fraction ³	Ethylbenzene Emissions (tpy)	Xylene Weight Fraction ³	Xylene Emissions (tpy)	n-Hexane Weight Fraction ³	n-Hexane Emissions (tpy)
Flanges - Gas Service	1.04E-04	3.34E-04	1.87E-04	5.99E-04	1.05E-05	3.37E-05	2.63E-05	8.42E-05	3.13E-03	1.00E-02
Valves - Gas Service	1.04E-04	3.40E-03	1.87E-04	6.10E-03	1.05E-05	3.43E-04	2.63E-05	8.57E-04	3.13E-03	1.02E-01
Compressor Seals - Gas Service	1.04E-04	3.46E-04	1.87E-04	6.20E-04	1.05E-05	3.49E-05	2.63E-05	8.71E-05	3.13E-03	1.04E-02
Flanges - Liquid Service	8.01E-04	3.40E-04	1.40E-03	5.97E-04	1.00E-06	4.26E-07	1.61E-04	6.82E-05	5.72E-02	2.43E-02
Valves - Liquid Service	8.01E-04	3.09E-03	1.40E-03	5.42E-03	1.00E-06	3.88E-06	1.61E-04	6.20E-04	5.72E-02	2.21E-01
Total Emissions (tons/yr)		0.0075		0.013		0.00042		0.0017		0.37

1) Component counts from Engineering Lists.

2) API average emission factors are for oil and gas production operations - Table 2.4, EPA Protocol for Equipment Leak Emission Estimates - 1995. However, because this facility will have an LDAR program, emission factors will likely more resemble those from Table 2.8, which are typically a magnitude lower.

3) Gas weight fractions from a site-specific gas analysis and liquid weight fractions from a site-specific ProMax model run.

GHG Fugitive Emissions								
Equipment Type and Service	Number of Units ¹	Hours of Operation (hours/yr)	Emission Factor ² (scf/hr-unit)	CH ₄ Concentration ³	CO ₂ Concentration ³	CH ₄ Emissions (tpy)	CO ₂ Emissions (tpy)	CO ₂ e Emissions (tpy)
Flanges - Gas Service	1,250	8,760	0.003	0.98	0.011	0.61	0.019	15.39
Valves - Gas Service	910	8,760	0.027	0.98	0.011	4.03	0.12	100.85
Compressor Seals - Gas Service	39	8,760	0.027	0.98	0.011	0.17	0.0053	4.32
Total Emissions (tons/yr)						4.82	0.15	120.57

1) Component counts from engineering lists.

2) Emission factors from 40 CFR Part 98 Subpart W, Table W1-A.

3) CH₄ and CO₂ concentrations as defined in 40 CFR Part 98.233(r).

Fugitive Emissions From Venting Episodes

Company:	Antero Midstream LLC
Facility Name:	Nichols Compressor Station
Facility Location:	Doddridge County, West Virginia
Source Description:	Fugitive Emissions-Venting Episodes

VOC Venting Emissions						
Type of Event ¹	Number Of Events (event/yr)	Amount Vented per Event (scf/event)	Molecular Weight of Vented Gas (lb/lb-mol)	Total Emissions (ton/yr)	VOC Weight Fraction ³	VOC Emissions (ton/yr)
Compressor Blowdown ²	936	2,237	20.43	56.35	0.17	9.35
Compressor Startup	936	1,050	20.43	26.45	0.17	4.39
Plant Shutdown	2	100,000	20.43	5.38	0.17	0.89
Low Pressure Pig Venting ³	198	516	20.43	2.74	0.17	0.46
High Pressure Pig Venting ³	260	2,801	20.43	19.60	0.17	3.25
Total Emissions (tons/yr)						18.34

HAPs Venting Emissions										
Type of Event ¹	Benzene Weight Fraction ³	Benzene Emissions (tpy)	Toluene Weight Fraction ³	Toluene Emissions (tpy)	Ethylbenzene Weight Fraction ³	Ethylbenzene Emissions (tpy)	Xylene Weight Fraction ³	Xylene Emissions (tpy)	n-Hexane Weight Fraction ³	n-Hexane Emissions (tpy)
Compressor Blowdown ²	1.03E-04	5.82E-03	1.85E-04	1.04E-02	1.04E-05	9.72E-05	2.60E-05	1.46E-03	3.09E-03	1.74E-01
Compressor Startup	1.03E-04	2.73E-03	1.85E-04	4.89E-03	1.04E-05	4.56E-05	2.60E-05	6.87E-04	3.09E-03	8.18E-02
Plant Shutdown	1.03E-04	5.56E-04	1.85E-04	9.95E-04	1.04E-05	9.28E-06	2.60E-05	1.40E-04	3.09E-03	1.66E-02
Low Pressure Pig Venting ³	1.03E-04	5.56E-04	1.85E-04	9.95E-04	1.04E-05	9.28E-06	2.60E-05	1.40E-04	3.09E-03	1.66E-02
High Pressure Pig Venting ³	1.03E-04	2.02E-03	1.85E-04	3.62E-03	1.04E-05	3.38E-05	2.60E-05	5.09E-04	3.09E-03	6.06E-02
Total Emissions (tons/yr)		0.012		0.021		0.00020		0.0029		0.35

GHG Venting Emissions								
Type of Event ¹	Number Of Events (event/yr)	Amount Vented per Event (scf/event)	Molecular Weight of Vented Gas (lb/lb-mol)	CH ₄ Weight Fraction ³	CO ₂ Weight Fraction ³	CH ₄ Emissions (ton/yr)	CO ₂ Emissions (ton/yr)	CO ₂ e Emissions (tpy)
Compressor Blowdown ²	936	2,237	20.43	0.62	0.0040	35.00	0.22	875.33
Compressor Startup	936	1,050	20.43	0.62	0.0040	16.43	0.11	410.95
Plant Shutdown	2	100,000	20.43	0.62	0.0040	3.34	0.021	83.63
Low Pressure Pig Venting ³	198	516	20.43	0.62	0.0040	1.70	0.011	42.63
High Pressure Pig Venting ³	260	2,801	20.43	0.62	0.0040	12.18	0.078	304.52
Total Emissions (tons/yr)						68.66	0.44	1,717.1

1) Estimated number of events and venting per event from engineering. Compressor blowdowns are calculated to be 120.4 lb/event.

2) Total number of compressor blowdowns based on 18 blowdowns per week.

3) Total number of pigging events based on expected operations.

4) Weight fractions are from a site-specific gas analysis.

Fugitive Dust Emissions

Company:	Antero Midstream LLC
Facility Name:	Nichols Compressor Station
Facility Location:	Doddridge County, West Virginia
Source Description:	Fugitive Dust Emissions

Gravel Access Road	Loaded Truck Weight ¹	Trips per year ²	Trips per day ²	Distance per round trip (truck in and out) ³		VMT per year ⁴
	tons			feet	miles	miles
Condensate Tank Truck	40.00	365	1.0	15,840	3.00	1,095
Produced Water Tank Truck	40.00	365	1.0	15,840	3.00	1,095

Equation Parameter	PM-10/PM2.5	PM-Total
E , annual size-specific emission factor for PM ₁₀ & PM _{2.5} (upaved industrial roads) extrapolated for natural mitigation ⁶	see table below	see table below
k , Particle size multiplier for particle size range (PM ₁₀), (lb/VMT) (Source: AP-42 Table 13.2.2-2)	1.5	4.9
k , Particle size multiplier for particle size range (PM _{2.5}), (lb/VMT) (Source: AP-42 Table 13.2.2-2)	0.15	
s , surface material silt content, (%) (Source: AP-42 Table 13.2.2-1)	4.8	4.8
W , mean weight (tons) of the vehicles traveling the road	40.00	40.00
a , constant for PM ₁₀ and PM _{2.5} on industrial roads (Source: AP-42 Table 13.2.2-2)	0.9	0.7
b , constant for PM ₁₀ and PM _{2.5} on industrial roads (Source: AP-42 Table 13.2.2-2)	0.45	0.45
P , number of "wet" days with at least 0.254 mm (0.01 in) of precipitation during the averaging period, based on AP-42 Figure 13.2.2-1.	160	160

$$E = \left[k \left(\frac{s}{12} \right)^a \times \left(\frac{W}{3} \right)^b \right] \times (365 - P/365)$$

Source of Equation: AP-42 Section 13.2.2

PM₁₀ Emissions

Emission Factor (lb/VMT)	Vehicle miles traveled (VMT/yr) ⁴	Annual Uncontrolled PM ₁₀ Emissions (tpy)
1.18	2,190.0	1.30

PM_{2.5} Emissions (tons/yr)

Emission Factor (lb/VMT)	Vehicle miles traveled (VMT/yr) ⁴	Annual Uncontrolled PM _{2.5} Emissions (tpy)
0.12	2,190.0	0.13

PM- Total Emissions (tons/yr)

Emission Factor (lb/VMT)	Vehicle miles traveled (VMT/yr) ⁴	Annual Uncontrolled PM-Total Emissions (tpy)
4.65	2,190.0	5.09

Notes:

1. Loaded truck weight is based on typical weight limit for highway vehicles.
2. Based on production, it's assumed a maximum of one condensate truck (200 bbl truck) and one produced water truck (200 bbl truck) will be onsite per day.
3. Distance per round trip is based on the site layout. The one way distance is measured as 7,920 feet for the gravel access road.
4. VMT/yr = Trips/yr x Roundtrip Distance
5. Hourly emissions determined from tons per year calculation using 2,000 lb/ton and 8,760 hours per year.

Facility Gas Analysis

	MOL %	MW lb/lb-mol	Component Weight lb/lb-mol	Wt. Fraction
Methane	79.12	16.04	12.69	0.62
Ethane	13.66	30.07	4.11	0.20
Propane	4.13	44.10	1.82	0.089
i-Butane	0.52	58.12	0.30	0.015
n-Butane	0.96	58.12	0.56	0.027
i-Pentane	0.27	72.15	0.20	0.010
n-Pentane	0.24	72.15	0.17	0.0084
Hexanes	0.13	106.72	0.14	0.0067
Heptanes	0.094	100.20	0.094	0.0046
Octanes	0.023	114.23	0.026	0.0013
Nonanes	0.0052	128.26	0.0067	0.00033
Decanes	0.00030	142.29	0.00	0.000021
n-Hexane	0.073	86.18	0.063	0.0031
Benzene	0.0027	78.11	0.0021	0.00010
Toluene	0.0041	92.14	0.0038	0.00018
Ethylbenzene	0.00020	106.16	0.000	0.000010
Xylenes	0.00050	106.16	0.00053	0.000026
Nitrogen	0.57	28.01	0.16	0.0078
Carbon Dioxide	0.18	44.01	0.081	0.0040
Totals	100.0		20.43	1.00

Heating Value (Btu/scf) 1,213.6
Molecular weight 20.43

VOC weight fraction 0.17
Methane weight fraction 0.62
THC weight fraction 0.99
VOC of THC wt fraction 0.17
CH4 of THC wt fraction 0.63
Benzene of THC wt fraction 0.00010
Toluene of THC wt fraction 0.00019
E-benzene of THC wt fraction 0.000011
Xylene of THC wt fraction 0.000026
n-Hexane of THC wt fraction 0.0031

1. Data from a site-specific gas analysis

GLYCalc 4.0

GRI-GLYCalc VERSION 4.0 - SUMMARY OF INPUT VALUES

Case Name: Nichols Compressor Station
File Name: W:\20171806 - Antero WV CS Permit Mods\Nichols CS
\Attachment N\Nichols Glycalc.ddf
Date: September 27, 2016

DESCRIPTION:

Description: 110 MMscfd
Gas injection pump

Annual Hours of Operation: 8760.0 hours/yr

WET GAS:

Temperature: 120.00 deg. F
Pressure: 1200.00 psig
Wet Gas Water Content: Saturated

Component	Conc. (vol %)
Carbon Dioxide	0.1844
Nitrogen	0.5688
Methane	79.1226
Ethane	13.6626
Propane	4.1333
Isobutane	0.5231
n-Butane	0.9624
Isopentane	0.2739
n-Pentane	0.2370
n-Hexane	0.0733
Other Hexanes	0.1284
Heptanes	0.0941
Benzene	0.0027
Toluene	0.0041
Ethylbenzene	0.0002
Xylenes	0.0005
C8+ Heavies	0.0286

DRY GAS:

Flow Rate: 110.0 MMSCF/day
Water Content: 5.0 lbs. H2O/MMSCF

LEAN GLYCOL:

Glycol Type: TEG
Water Content: 1.5 wt% H2O
Flow Rate: 15.0 gpm

PUMP:

Glycol Pump Type: Gas Injection
Gas Injection Pump Volume Ratio: 0.032 acfm gas/gpm
glycol

FLASH TANK:

Flash Control: Combustion device
Flash Control Efficiency: 98.00 %
Temperature: 130.0 deg. F
Pressure: 60.0 psig

STRIPPING GAS:

Source of Gas: Dry Gas
Gas Flow Rate: 9.000 scfm

REGENERATOR OVERHEADS CONTROL DEVICE:

Control Device: Condenser
Temperature: 145.0 deg. F
Pressure: 14.7 psia

Control Device: Combustion Device
Destruction Efficiency: 98.0 %
Excess Oxygen: 0.0 %
Ambient Air Temperature: 0.0 deg. F

Nichols Glycalc - Outputs

GRI-GLYCalc VERSION 4.0 - AGGREGATE CALCULATIONS REPORT

Case Name: Nichols Compressor Station

File Name: w:\20171806 - Antero WV CS Permit Mods\Nichols CS\Attachment N\Nichols Glycalc.ddf

Date: September 27, 2016

DESCRIPTION:

Description: 110 MMscfd
Gas injection pump

Annual Hours of Operation: 8760.0 hours/yr

EMISSIONS REPORTS:

CONTROLLED REGENERATOR EMISSIONS

Component	lbs/hr	lbs/day	tons/yr
Methane	0.3928	9.427	1.7204
Ethane	0.1608	3.860	0.7045
Propane	0.1017	2.441	0.4454
Isobutane	0.0214	0.514	0.0938
n-Butane	0.0496	1.189	0.2171
Isopentane	0.0176	0.422	0.0769
n-Pentane	0.0189	0.454	0.0829
n-Hexane	0.0113	0.271	0.0494
Other Hexanes	0.0150	0.359	0.0655
Heptanes	0.0310	0.743	0.1357
Benzene	0.0234	0.561	0.1024
Toluene	0.0514	1.234	0.2252
Ethylbenzene	0.0031	0.075	0.0137
xylene	0.0108	0.258	0.0472
C8+ Heavies	0.0118	0.283	0.0517
Total Emissions	0.9205	22.092	4.0318
Total Hydrocarbon Emissions	0.9205	22.092	4.0318
Total VOC Emissions	0.3669	8.805	1.6068
Total HAP Emissions	0.1000	2.399	0.4378
Total BTEX Emissions	0.0887	2.128	0.3884

UNCONTROLLED REGENERATOR EMISSIONS

Component	lbs/hr	lbs/day	tons/yr
Methane	19.6432	471.437	86.0373
Ethane	8.0449	193.078	35.2367
Propane	5.0887	122.128	22.2884
Isobutane	1.0726	25.741	4.6978
n-Butane	2.4822	59.573	10.8720

Nichols Glycolc - Outputs

Isopentane	0.8812	21.149	3.8596
n-Pentane	0.9503	22.808	4.1624
n-Hexane	0.5686	13.647	2.4905
Other Hexanes	0.7533	18.079	3.2994
Heptanes	1.5806	37.935	6.9231
Benzene	1.1928	28.627	5.2244
Toluene	2.6745	64.189	11.7144
Ethylbenzene	0.1682	4.036	0.7366
Xylenes	0.5889	14.134	2.5795
C8+ Heavies	2.7616	66.279	12.0958

Total Emissions	48.4516	1162.838	212.2180
Total Hydrocarbon Emissions	48.4516	1162.838	212.2180
Total VOC Emissions	20.7635	498.323	90.9440
Total HAP Emissions	5.1930	124.632	22.7454
Total BTEX Emissions	4.6244	110.986	20.2549

FLASH GAS EMISSIONS

Component	lbs/hr	lbs/day	tons/yr
Methane	2.2756	54.614	9.9671
Ethane	0.9629	23.110	4.2175
Propane	0.4649	11.159	2.0364
Isobutane	0.0809	1.942	0.3544
n-Butane	0.1631	3.915	0.7144
Isopentane	0.0520	1.248	0.2277
n-Pentane	0.0491	1.178	0.2149
n-Hexane	0.0189	0.454	0.0829
Other Hexanes	0.0311	0.747	0.1364
Heptanes	0.0290	0.695	0.1269
Benzene	0.0016	0.038	0.0070
Toluene	0.0024	0.057	0.0104
Ethylbenzene	0.0001	0.002	0.0004
Xylenes	0.0002	0.005	0.0009
C8+ Heavies	0.0056	0.134	0.0244

Total Emissions	4.1374	99.298	18.1218
Total Hydrocarbon Emissions	4.1374	99.298	18.1218
Total VOC Emissions	0.8989	21.574	3.9372
Total HAP Emissions	0.0232	0.557	0.1016
Total BTEX Emissions	0.0043	0.103	0.0187

FLASH TANK OFF GAS

Component	lbs/hr	lbs/day	tons/yr
Methane	113.7792	2730.700	498.3528
Ethane	48.1455	1155.493	210.8774
Propane	23.2469	557.926	101.8214
Isobutane	4.0458	97.099	17.7206
n-Butane	8.1557	195.737	35.7221
Isopentane	2.5996	62.392	11.3865

Nichols Glycolc - Outputs			
n-Pentane	2.4533	58.878	10.7453
n-Hexane	0.9461	22.707	4.1440
Other Hexanes	1.5570	37.368	6.8196
Heptanes	1.4486	34.766	6.3449

Benzene	0.0802	1.924	0.3511
Toluene	0.1189	2.854	0.5208
Ethylbenzene	0.0044	0.106	0.0194
Xylenes	0.0105	0.251	0.0458
C8+ Heavies	0.2783	6.679	1.2190

Total Emissions	206.8700	4964.880	906.0907
-----------------	----------	----------	----------

Total Hydrocarbon Emissions	206.8700	4964.880	906.0907
Total VOC Emissions	44.9453	1078.688	196.8605
Total HAP Emissions	1.1601	27.842	5.0812
Total BTEX Emissions	0.2140	5.135	0.9372

EQUIPMENT REPORTS:

CONDENSER AND COMBUSTION DEVICE

Condenser Outlet Temperature: 145.00 deg. F
 Condenser Pressure: 14.70 psia
 Condenser Duty: 2.12e-001 MM BTU/hr
 Hydrocarbon Recovery: 0.19 bbls/day
 Produced Water: 25.95 bbls/day
 Ambient Temperature: 0.00 deg. F
 Excess Oxygen: 0.00 %
 Combustion Efficiency: 98.00 %
 Supplemental Fuel Requirement: 2.12e-001 MM BTU/hr

Component	Emitted	Destroyed
Methane	2.00%	98.00%
Ethane	2.00%	98.00%
Propane	2.00%	98.00%
Isobutane	2.00%	98.00%
n-Butane	2.00%	98.00%
Isopentane	1.99%	98.01%
n-Pentane	1.99%	98.01%
n-Hexane	1.98%	98.02%
Other Hexanes	1.99%	98.01%
Heptanes	1.96%	98.04%
Benzene	1.96%	98.04%
Toluene	1.92%	98.08%
Ethylbenzene	1.86%	98.14%
xylenes	1.83%	98.17%
C8+ Heavies	0.43%	99.57%

ABSORBER

Nichols Glycalc - Outputs

Calculated Absorber Stages: 1.68
 Specified Dry Gas Dew Point: 5.00 lbs. H2O/MMSCF
 Temperature: 120.0 deg. F
 Pressure: 1200.0 psig
 Dry Gas Flow Rate: 110.0000 MMSCF/day
 Glycol Losses with Dry Gas: 8.4316 lb/hr
 Wet Gas Water Content: Saturated
 Calculated Wet Gas Water Content: 89.60 lbs. H2O/MMSCF
 Calculated Lean Glycol Recirc. Ratio: 2.32 gal/lb H2O

Component	Remaining in Dry Gas	Absorbed in Glycol
Water	5.57%	94.43%
Carbon Dioxide	99.81%	0.19%
Nitrogen	99.98%	0.02%
Methane	99.98%	0.02%
Ethane	99.96%	0.04%
Propane	99.94%	0.06%
Isobutane	99.93%	0.07%
n-Butane	99.91%	0.09%
Isopentane	99.92%	0.08%
n-Pentane	99.91%	0.09%
n-Hexane	99.87%	0.13%
Other Hexanes	99.90%	0.10%
Heptanes	99.80%	0.20%
Benzene	95.07%	4.93%
Toluene	93.95%	6.05%
Ethylbenzene	93.34%	6.66%
Xylenes	90.72%	9.28%
C8+ Heavies	99.55%	0.45%

FLASH TANK

Flash Control: Combustion device
 Flash Control Efficiency: 98.00 %
 Flash Temperature: 130.0 deg. F
 Flash Pressure: 60.0 psig

Component	Left in Glycol	Removed in Flash Gas
Water	99.85%	0.15%
Carbon Dioxide	14.29%	85.71%
Nitrogen	1.29%	98.71%
Methane	1.37%	98.63%
Ethane	4.37%	95.63%
Propane	9.69%	90.31%
Isobutane	13.66%	86.34%
n-Butane	17.14%	82.86%
Isopentane	18.99%	81.01%
n-Pentane	22.62%	77.38%
n-Hexane	33.83%	66.17%
Other Hexanes	28.14%	71.86%

Nichols Glycalc - Outputs		
Heptanes	50.16%	49.84%
Benzene	94.00%	6.00%
Toluene	96.07%	3.93%
Ethylbenzene	97.69%	2.31%
Xylenes	98.48%	1.52%
C8+ Heavies	91.64%	8.36%

REGENERATOR

Regenerator Stripping Gas:
Dry Product Gas

Stripping Gas Flow Rate: 9.0000 scfm

Component	Remaining in Glycol	Distilled Overhead
Water	24.61%	75.39%
Carbon Dioxide	0.00%	100.00%
Nitrogen	0.00%	100.00%
Methane	0.00%	100.00%
Ethane	0.00%	100.00%
Propane	0.00%	100.00%
Isobutane	0.00%	100.00%
n-Butane	0.00%	100.00%
Isopentane	1.49%	98.51%
n-Pentane	1.37%	98.63%
n-Hexane	1.02%	98.98%
Other Hexanes	2.27%	97.73%
Heptanes	0.77%	99.23%
Benzene	5.26%	94.74%
Toluene	8.16%	91.84%
Ethylbenzene	10.58%	89.42%
Xylenes	13.08%	86.92%
C8+ Heavies	11.78%	88.22%

STREAM REPORTS:

WET GAS STREAM

Temperature: 120.00 deg. F
Pressure: 1214.70 psia
Flow Rate: 4.59e+006 scfh

Component	Conc. (vol%)	Loading (lb/hr)
Water	1.89e-001	4.12e+002
Carbon Dioxide	1.84e-001	9.81e+002
Nitrogen	5.68e-001	1.92e+003
Methane	7.90e+001	1.53e+005

Nichols Glycalc - Outputs
Ethane 1.36e+001 4.96e+004

Propane 4.13e+000 2.20e+004
Isobutane 5.22e-001 3.67e+003
n-Butane 9.61e-001 6.76e+003
Isopentane 2.73e-001 2.39e+003
n-Pentane 2.37e-001 2.07e+003

n-Hexane 7.32e-002 7.63e+002
Other Hexanes 1.28e-001 1.34e+003
Heptanes 9.39e-002 1.14e+003
Benzene 2.69e-003 2.55e+001
Toluene 4.09e-003 4.56e+001

Ethylbenzene 2.00e-004 2.57e+000
xylenes 4.99e-004 6.41e+000
C8+ Heavies 2.85e-002 5.89e+002

Total Components 100.00 2.47e+005

DRY GAS STREAM

Temperature: 120.00 deg. F
Pressure: 1214.70 psia
Flow Rate: 4.58e+006 scfh

Component	Conc. (vol%)	Loading (lb/hr)
Water	1.05e-002	2.29e+001
Carbon Dioxide	1.84e-001	9.79e+002
Nitrogen	5.69e-001	1.92e+003
Methane	7.91e+001	1.53e+005
Ethane	1.37e+001	4.96e+004
Propane	4.13e+000	2.20e+004
Isobutane	5.23e-001	3.67e+003
n-Butane	9.62e-001	6.75e+003
Isopentane	2.74e-001	2.39e+003
n-Pentane	2.37e-001	2.06e+003
n-Hexane	7.32e-002	7.62e+002
Other Hexanes	1.28e-001	1.34e+003
Heptanes	9.39e-002	1.14e+003
Benzene	2.57e-003	2.42e+001
Toluene	3.85e-003	4.29e+001
Ethylbenzene	1.87e-004	2.39e+000
xylenes	4.54e-004	5.82e+000
C8+ Heavies	2.85e-002	5.86e+002
-----	-----	-----
Total Components	100.00	2.47e+005

LEAN GLYCOL STREAM

Temperature: 120.00 deg. F
Flow Rate: 1.50e+001 gpm

Component	Conc.	Loading
	Page 6	

Nichols Glycalc - Outputs
(wt%) (lb/hr)

TEG	9.85e+001	8.32e+003
Water	1.50e+000	1.27e+002
Carbon Dioxide	2.18e-012	1.84e-010
Nitrogen	4.56e-013	3.85e-011
Methane	1.03e-017	8.69e-016
Ethane	1.19e-007	1.01e-005
Propane	6.21e-009	5.25e-007
Isobutane	9.03e-010	7.63e-008
n-Butane	1.73e-009	1.46e-007
Isopentane	1.07e-004	9.08e-003
n-Pentane	1.16e-004	9.82e-003
n-Hexane	5.83e-005	4.92e-003
Other Hexanes	1.64e-004	1.39e-002
Heptanes	1.33e-004	1.12e-002
Benzene	7.83e-004	6.61e-002
Toluene	2.81e-003	2.37e-001
Ethylbenzene	2.35e-004	1.99e-002
Xylenes	1.05e-003	8.86e-002
C8+ Heavies	4.26e-003	3.60e-001
Total Components	100.00	8.44e+003

RICH GLYCOL AND PUMP GAS STREAM

Temperature: 120.00 deg. F
 Pressure: 1214.70 psia
 Flow Rate: 1.63e+001 gpm
 NOTE: Stream has more than one phase.

Component	Conc. (wt%)	Loading (lb/hr)
TEG	9.18e+001	8.31e+003
Water	5.69e+000	5.16e+002
Carbon Dioxide	2.67e-002	2.42e+000
Nitrogen	1.67e-002	1.51e+000
Methane	1.27e+000	1.15e+002
Ethane	5.56e-001	5.03e+001
Propane	2.84e-001	2.57e+001
Isobutane	5.17e-002	4.69e+000
n-Butane	1.09e-001	9.84e+000
Isopentane	3.54e-002	3.21e+000
n-Pentane	3.50e-002	3.17e+000
n-Hexane	1.58e-002	1.43e+000
Other Hexanes	2.39e-002	2.17e+000
Heptanes	3.21e-002	2.91e+000
Benzene	1.48e-002	1.34e+000
Toluene	3.34e-002	3.03e+000
Ethylbenzene	2.12e-003	1.92e-001
xylenes	7.59e-003	6.87e-001
C8+ Heavies	3.68e-002	3.33e+000
Total Components	100.00	9.06e+003

Nichols Glycalc - Outputs

FLASH TANK OFF GAS STREAM

Temperature: 130.00 deg. F
 Pressure: 74.70 psia
 Flow Rate: 3.68e+003 scfh

Component	Conc. (vol%)	Loading (lb/hr)
Water	4.29e-001	7.49e-001
Carbon Dioxide	4.85e-001	2.07e+000
Nitrogen	5.49e-001	1.49e+000
Methane	7.32e+001	1.14e+002
Ethane	1.65e+001	4.81e+001
Propane	5.44e+000	2.32e+001
Isobutane	7.18e-001	4.05e+000
n-Butane	1.45e+000	8.16e+000
Isopentane	3.72e-001	2.60e+000
n-Pentane	3.51e-001	2.45e+000
n-Hexane	1.13e-001	9.46e-001
Other Hexanes	1.86e-001	1.56e+000
Heptanes	1.49e-001	1.45e+000
Benzene	1.06e-002	8.02e-002
Toluene	1.33e-002	1.19e-001
Ethylbenzene	4.31e-004	4.43e-003
Xylenes	1.02e-003	1.05e-002
C8+ Heavies	1.69e-002	2.78e-001
Total Components	100.00	2.11e+002

FLASH TANK GLYCOL STREAM

Temperature: 130.00 deg. F
 Flow Rate: 1.58e+001 gpm

Component	Conc. (wt%)	Loading (lb/hr)
TEG	9.39e+001	8.31e+003
Water	5.82e+000	5.15e+002
Carbon Dioxide	3.90e-003	3.45e-001
Nitrogen	2.20e-004	1.94e-002
Methane	1.79e-002	1.58e+000
Ethane	2.49e-002	2.20e+000
Propane	2.82e-002	2.50e+000
Isobutane	7.24e-003	6.40e-001
n-Butane	1.91e-002	1.69e+000
Isopentane	6.89e-003	6.09e-001
n-Pentane	8.11e-003	7.17e-001
n-Hexane	5.47e-003	4.84e-001
Other Hexanes	6.89e-003	6.10e-001
Heptanes	1.65e-002	1.46e+000
Benzene	1.42e-002	1.26e+000

Nichols Glycolc - Outputs

Toluene	3.29e-002	2.91e+000
Ethylbenzene	2.12e-003	1.88e-001
xylenes	7.65e-003	6.77e-001
C8+ Heavies	3.45e-002	3.05e+000

 Total Components 100.00 8.85e+003

FLASH GAS EMISSIONS

 Flow Rate: 1.36e+004 scfh
 Control Method: Combustion Device
 Control Efficiency: 98.00

Component	Conc. (vol%)	Loading (lb/hr)
-----	-----	-----
Water	6.27e+001	4.05e+002
Carbon Dioxide	3.66e+001	5.79e+002
Nitrogen	1.48e-001	1.49e+000
Methane	3.95e-001	2.28e+000
Ethane	8.92e-002	9.63e-001
Propane	2.94e-002	4.65e-001
Isobutane	3.88e-003	8.09e-002
n-Butane	7.82e-003	1.63e-001
Isopentane	2.01e-003	5.20e-002
n-Pentane	1.89e-003	4.91e-002
n-Hexane	6.12e-004	1.89e-002
Other Hexanes	1.01e-003	3.11e-002
Heptanes	8.05e-004	2.90e-002
Benzene	5.72e-005	1.60e-003
Toluene	7.19e-005	2.38e-003
Ethylbenzene	2.32e-006	8.86e-005
xylenes	5.49e-006	2.09e-004
C8+ Heavies	9.10e-005	5.57e-003
-----	-----	-----
Total Components	100.00	9.90e+002

REGENERATOR OVERHEADS STREAM

 Temperature: 212.00 deg. F
 Pressure: 14.70 psia
 Flow Rate: 8.86e+003 scfh

Component	Conc. (vol%)	Loading (lb/hr)
-----	-----	-----
Water	9.22e+001	3.88e+002
Carbon Dioxide	4.48e-002	4.60e-001
Nitrogen	3.76e-002	2.46e-001
Methane	5.24e+000	1.96e+001
Ethane	1.15e+000	8.04e+000
Propane	4.94e-001	5.09e+000
Isobutane	7.90e-002	1.07e+000
n-Butane	1.83e-001	2.48e+000

Nichols Glycalc - Outputs

Isopentane	5.23e-002	8.81e-001
n-Pentane	5.64e-002	9.50e-001
n-Hexane	2.82e-002	5.69e-001
Other Hexanes	3.74e-002	7.53e-001
Heptanes	6.75e-002	1.58e+000
Benzene	6.54e-002	1.19e+000
Toluene	1.24e-001	2.67e+000
Ethylbenzene	6.78e-003	1.68e-001
Xylenes	2.37e-002	5.89e-001
C8+ Heavies	6.94e-002	2.76e+000

Total Components	100.00	4.37e+002

CONDENSER PRODUCED WATER STREAM

Temperature: 145.00 deg. F
Flow Rate: 7.57e-001 gpm

Component	Conc. (wt%)	Loading (lb/hr)	(ppm)
Water	1.00e+002	3.79e+002	999887.
Carbon Dioxide	3.15e-004	1.19e-003	3.
Nitrogen	5.19e-006	1.97e-005	0.
Methane	7.54e-004	2.86e-003	8.
Ethane	3.35e-004	1.27e-003	3.
Propane	2.53e-004	9.57e-004	3.
Isobutane	2.83e-005	1.07e-004	0.
n-Butane	8.43e-005	3.19e-004	1.
Isopentane	2.04e-005	7.71e-005	0.
n-Pentane	2.33e-005	8.81e-005	0.
n-Hexane	1.10e-005	4.16e-005	0.
Other Hexanes	1.19e-005	4.52e-005	0.
Heptanes	1.62e-005	6.14e-005	0.
Benzene	2.96e-003	1.12e-002	30.
Toluene	5.15e-003	1.95e-002	52.
Ethylbenzene	2.28e-004	8.63e-004	2.
xylenes	1.06e-003	4.01e-003	11.
C8+ Heavies	2.82e-006	1.07e-005	0.

Total Components	100.00	3.79e+002	1000000.

CONDENSER RECOVERED OIL STREAM

Temperature: 145.00 deg. F
Flow Rate: 5.61e-003 gpm

Component	Conc. (wt%)	Loading (lb/hr)
Water	2.80e-002	6.69e-004
Carbon Dioxide	1.14e-003	2.72e-005
Nitrogen	5.39e-005	1.28e-006
Methane	2.31e-002	5.52e-004

Nichols Glycalc - Outputs
Ethane 5.01e-002 1.20e-003

Propane 1.39e-001 3.31e-003
Isobutane 5.28e-002 1.26e-003
n-Butane 1.58e-001 3.77e-003
Isopentane 1.16e-001 2.78e-003
n-Pentane 1.50e-001 3.57e-003

n-Hexane 1.96e-001 4.67e-003
Other Hexanes 2.21e-001 5.27e-003
Heptanes 1.34e+000 3.20e-002
Benzene 5.52e-001 1.32e-002
Toluene 3.53e+000 8.41e-002

Ethylbenzene 4.61e-001 1.10e-002
xylenes 1.95e+000 4.65e-002
C8+ Heavies 9.10e+001 2.17e+000

Total Components 100.00 2.39e+000

CONDENSER VENT STREAM

Temperature: 145.00 deg. F
Pressure: 14.70 psia
Flow Rate: 8.79e+002 scfh

Component	Conc. (vol%)	Loading (lb/hr)
Water	2.25e+001	9.38e+000
Carbon Dioxide	4.50e-001	4.59e-001
Nitrogen	3.79e-001	2.46e-001
Methane	5.28e+001	1.96e+001
Ethane	1.15e+001	8.04e+000
Propane	4.98e+000	5.08e+000
Isobutane	7.95e-001	1.07e+000
n-Butane	1.84e+000	2.48e+000
Isopentane	5.25e-001	8.78e-001
n-Pentane	5.66e-001	9.47e-001
n-Hexane	2.82e-001	5.64e-001
Other Hexanes	3.75e-001	7.48e-001
Heptanes	6.67e-001	1.55e+000
Benzene	6.46e-001	1.17e+000
Toluene	1.20e+000	2.57e+000
Ethylbenzene	6.35e-002	1.56e-001
xylenes	2.19e-001	5.38e-001
C8+ Heavies	1.49e-001	5.90e-001
-----	-----	-----
Total Components	100.00	5.61e+001

COMBUSTION DEVICE OFF GAS STREAM

Temperature: 1000.00 deg. F
Pressure: 14.70 psia
Flow Rate: 1.35e+001 scfh

Component	Nichols Glycalc - Conc. (vol%)	Outputs Loading (lb/hr)
Methane	6.89e+001	3.93e-001
Ethane	1.51e+001	1.61e-001
Propane	6.49e+000	1.02e-001
Isobutane	1.04e+000	2.14e-002
n-Butane	2.40e+000	4.96e-002
Isopentane	6.85e-001	1.76e-002
n-Pentane	7.38e-001	1.89e-002
n-Hexane	3.68e-001	1.13e-002
Other Hexanes	4.88e-001	1.50e-002
Heptanes	8.70e-001	3.10e-002
Benzene	8.42e-001	2.34e-002
Toluene	1.57e+000	5.14e-002
Ethylbenzene	8.28e-002	3.13e-003
Xylenes	2.85e-001	1.08e-002
C8+ Heavies	1.95e-001	1.18e-002
Total Components	100.00	9.21e-001

Tanks 4.09d

TANKS 4.0.9d
Emissions Report - Detail Format
Tank Identification and Physical Characteristics

Identification

User Identification:	Nichols CS
City:	Doddridge County
State:	West Virginia
Company:	Antero Midstream LLC
Type of Tank:	Vertical Fixed Roof Tank
Description:	1 x 500 bbl Settling Tank

Tank Dimensions

Shell Height (ft):	25.00
Diameter (ft):	12.00
Liquid Height (ft) :	24.00
Avg. Liquid Height (ft):	12.50
Volume (gallons):	20,304.71
Turnovers:	147.68
Net Throughput(gal/yr):	2,998,548.00
Is Tank Heated (y/n):	N

Paint Characteristics

Shell Color/Shade:	Gray/Medium
Shell Condition:	Good
Roof Color/Shade:	Gray/Medium
Roof Condition:	Good

Roof Characteristics

Type:	Dome
Height (ft)	1.00
Radius (ft) (Dome Roof)	12.00

Breather Vent Settings

Vacuum Settings (psig):	-0.03
Pressure Settings (psig)	0.03

Meteorological Data used in Emissions Calculations: Elkins, West Virginia (Avg Atmospheric Pressure = 13.73 psia)

TANKS 4.0.9d
Emissions Report - Detail Format
Liquid Contents of Storage Tank

Nichols CS - Vertical Fixed Roof Tank
Doddridge County, West Virginia

Mixture/Component	Month	Daily Liquid Surf. Temperature (deg F)			Liquid Bulk Temp (deg F)	Vapor Pressure (psia)			Vapor Mol. Weight.	Liquid Mass Fract.	Vapor Mass Fract.	Mol. Weight	Basis for Vapor Pressure Calculations
		Avg.	Min.	Max.		Avg.	Min.	Max.					
Gasoline (RVP 15.0)	All	57.20	47.16	67.23	52.14	7.7391	6.4053	9.2837	60.0000			92.00	Option 4: RVP=15, ASTM Slope=3

TANKS 4.0.9d
Emissions Report - Detail Format
Detail Calculations (AP-42)

Nichols CS - Vertical Fixed Roof Tank
Doddridge County, West Virginia

Annual Emission Calculations	
Standing Losses (lb):	3,888.3377
Vapor Space Volume (cu ft):	1,470.7890
Vapor Density (lb/cu ft):	0.0837
Vapor Space Expansion Factor:	0.5480
Vented Vapor Saturation Factor:	0.1579
Tank Vapor Space Volume:	
Vapor Space Volume (cu ft):	1,470.7890
Tank Diameter (ft):	12.0000
Vapor Space Outage (ft):	13.0046
Tank Shell Height (ft):	25.0000
Average Liquid Height (ft):	12.5000
Roof Outage (ft):	0.5046
Roof Outage (Dome Roof)	
Roof Outage (ft):	0.5046
Dome Radius (ft):	12.0000
Shell Radius (ft):	6.0000
Vapor Density	
Vapor Density (lb/cu ft):	0.0837
Vapor Molecular Weight (lb/lb-mole):	60.0000
Vapor Pressure at Daily Average Liquid Surface Temperature (psia):	7.7391
Daily Avg. Liquid Surface Temp. (deg. R):	516.8667
Daily Average Ambient Temp. (deg. F):	49.0583
Ideal Gas Constant R (psia cu ft / (lb-mol-deg R)):	10.731
Liquid Bulk Temperature (deg. R):	511.8083
Tank Paint Solar Absorptance (Shell):	0.6800
Tank Paint Solar Absorptance (Roof):	0.6800
Daily Total Solar Insulation Factor (Btu/sqft day):	1,193.8870
Vapor Space Expansion Factor	
Vapor Space Expansion Factor:	0.5480
Daily Vapor Temperature Range (deg. R):	40.1436
Daily Vapor Pressure Range (psia):	2.8784
Breather Vent Press. Settling Range (psia):	0.0600
Vapor Pressure at Daily Average Liquid Surface Temperature (psia):	7.7391
Vapor Pressure at Daily Minimum Liquid Surface Temperature (psia):	6.4053
Vapor Pressure at Daily Maximum Liquid Surface Temperature (psia):	9.2837
Daily Avg. Liquid Surface Temp. (deg R):	516.8667
Daily Min. Liquid Surface Temp. (deg R):	506.8308
Daily Max. Liquid Surface Temp. (deg R):	526.9026
Daily Ambient Temp. Range (deg. R):	24.1833
Vented Vapor Saturation Factor	
Vented Vapor Saturation Factor:	0.1579
Vapor Pressure at Daily Average Liquid Surface Temperature (psia):	7.7391
Vapor Space Outage (ft):	13.0046
Working Losses (lb):	
Working Losses (lb):	12,259.9081
Vapor Molecular Weight (lb/lb-mole):	60.0000
Vapor Pressure at Daily Average Liquid Surface Temperature (psia):	7.7391
Annual Net Throughput (gal/yr.):	2,998,548.0000
Annual Turnovers:	147.6775
Turnover Factor:	0.3698
Maximum Liquid Volume (gal):	20,304.7110
Maximum Liquid Height (ft):	24.0000
Tank Diameter (ft):	12.0000
Working Loss Product Factor:	1.0000
Total Losses (lb):	16,148.2458

TANKS 4.0.9d
Emissions Report - Detail Format
Individual Tank Emission Totals

Emissions Report for: Annual

Nichols CS - Vertical Fixed Roof Tank
Doddridge County, West Virginia

Components	Losses(lbs)		
	Working Loss	Breathing Loss	Total Emissions
Gasoline (RVP 15.0)	12,259.91	3,888.34	16,148.25

Attachment O.
Monitoring, Recordkeeping, Reporting, and Testing Plans

Monitoring, Recordkeeping, Reporting, and Testing Plans

The following is a summary of the methods to comply with the requirements of West Virginia Division of Air Quality (WVDAQ) 45CSR13 rules and regulations for the Nichols Compressor Station, including federal and state regulatory requirements.

1. Summary of Key Operational Throughput Limits

- a. Maximum wet gas throughput into each Dehy (RSV-1 and RSV-2): 110 MMscf/day or 40,150 MMscf/year.
- b. Maximum liquids loaded out (EPLOR): 2,998,548 gallons per year.

2. Operational Requirements

- a. Compressor engines will operate with the catalytic converter in place at all times and will be fueled by natural gas only.
- b. Catalysts installed on all compressor engines will be operated per manufacturer instructions.
- c. Reciprocating compressor rod packing will be replaced within 36 months of last packing/startup or within 26,000 operating hours, whichever comes first.
- d. Microturbines will be be fueled by natural gas only.
- e. Each dehydrator reboiler will be operated at no more than 1.5 MMBtu/hr and fueled only by natural gas or off-gases from the dehydrator flash tanks.
- f. No fuel-burning unit of any kind will have opacity greater than 10 percent based on a six minute block average observation.
- g. The combustor capacity will not exceed 4.80 MMBtu/hr, will achieve 98 percent destruction efficiency, will operate at all times that gas is vented to it, will have a flame present at all times, and will have no visible emissions other than for periods not to exceed a total of 5 minutes during any 2 consecutive hours.
- h. The combustor will be operated per manufacturer instructions.
- i. Produced water, Condensate, and Settling storage tanks potential emissions shall be routed to the VRU with recovery greater than 98 percent at all times.
- j. Storage tanks must be covered and routed to a closed vent system with no detectable emissions.
- k. Liquid loadout trucks must use the submerged-fill method.
- l. Dehydrator still vents must be controlled by the combustor.
- m. Dehydrator flash tank vent gas is to be used in the reboiler as fuel or routed to the VRU system.

3. Monitoring

- a. Non-certified engines will be stack tested within 1 year of startup and every 8,760 hours of operation thereafter.
- b. Catalyst inlet temperature will be monitored.
- c. Compressor run time will be monitored as well as number of months since compressor rod repacking.

- d. A rolling 12-month average of the wet gas throughput for the dehydrators will be monitored.
- e. Initial Method 22 observations of each reboiler exhaust and combustor will be conducted for a minimum of 2 hours.
- f. Monthly Method 22 observations of each reboiler exhaust and combustor will be conducted for a minimum of 10 minutes each.
- g. Monthly olfactory, visual, and auditory inspections of the tanks closed vent and control system (combustor) will be conducted for leaks or defects that could result in emissions. Leaks will be repaired as soon as practicable (no later than 5 days for first attempt).
- h. The presence of combustor flame will be continuously monitored by a thermocouple.
- i. Monthly and rolling twelve-month average of the amount of liquids loaded out will be monitored.
- j. The initial and subsequent leak detection and repair (LDAR) inspections will be conducted per the implemented LDAR monitoring plan. Repair procedures will be followed per the implemented LDAR monitoring plan.

4. Recordkeeping

- a. Records will be kept on-site for a minimum of 2 years, and in company records (on or off-site) for a minimum of 5 years.
- b. Records will be kept of inspection, observations, preventive maintenance, malfunctions, and shutdowns of all onsite equipment.
- c. Records will be kept of the date, time, and duration of each time that a flame is not present at the combustor, and startup, shutdown, malfunctions of the combustor.
- d. Records will be kept of engine maintenance and engine run time.
- e. Records will be kept of catalyst inlet temperature.
- f. Records will be kept of the actual annual average natural gas throughput in the dehydrators.
- g. Records of LDAR inspections, repaired leaks, and the LDAR monitoring plan will be kept.

5. Notifications and Reports

- a. WVDAQ will be notified within 30 calendar days of startup.
- b. Upon startup, a Certificate to Operate (CTO) application will be filed and fees paid to WVDAQ for the period from startup to the following June 30 and then annually the CTO will be renewed and fees paid. CTO will be maintained on-site.
- c. An annual report will be filed for compliance with 40 CFR 60 Subpart OOOO for the settling tank within 90 days after one year of operation (i.e., within 90 days after 12 months after initial startup).
- d. An annual report of compliance with 40CFR 60 Subpart OOOOa for the compressor engines and LDAR requirements will be submitted within 90 days after one year of modification (i.e. within 90 days after 12 months after initial startup of the added compressor engines).
- e. For stack testing, a protocol will be filed at least 30 days prior to test and WVDAQ and EPA will be notified of the test at least 15 days prior to test. Results will be reported within 60 days of test.
- f. If operations are suspended for 60 days or more, WVDAQ will be notified within 2 weeks after the 60th day.

**Attachment P.
Public Notice**

AIR QUALITY PERMIT NOTICE
Notice of Application – Nichols Compressor Station

Notice is given that Antero Midstream LLC has applied to the West Virginia Department of Environmental Protection, Division of Air Quality, for a modification to the existing 45CSR13 Construction Permit R13-3201B for the Nichols Compressor Station located at 2189 Long Run Road, in Doddridge County, West Virginia. The latitude and longitude coordinates are: 39.2926N, 80.8695W.

The applicant estimates the change in the potential to discharge of the following Regulated Air Pollutants will be:

Regulated Air Pollutant	Modified Potential Emissions (tons/yr)
Nitrogen Oxides (NO _x)	0.21
Carbon Monoxide (CO)	0.18
Volatile Organic Compounds (VOC)	7.25
Particulate Matter less than 10 μm (PM ₁₀)	0.02
Particulate Matter less than 2.5 μm (PM _{2.5})	0.02
Sulfur Dioxide (SO ₂)	0.0
Formaldehyde (HCHO)	0.0
Total HAPs	-0.48
Greenhouse Gases (CO ₂ e)	1,311

Please note that negative numbers in the table indicate a decrease in potential to emit.

Written comments will be received by the West Virginia Department of Environmental Protection, Division of Air Quality, 601 57th Street, SE, Charleston, WV 25304, for at least 30 calendar days from the date of publication of this notice.

Any questions regarding this permit application should be directed to the DAQ at (304) 926-0499, extension 1250, during normal business hours.

Dated the 21st day of October 2016.

By: Antero Midstream LLC
Barry Schatz
Senior Environmental and Regulatory Manager
1615 Wynkoop Street
Denver, CO 80202

**Attachment R.
Authority/Delegation of Authority**

**Attachment R
AUTHORITY OF CORPORATION
OR OTHER BUSINESS ENTITY (DOMESTIC OR FOREIGN)**

TO: The West Virginia Department of Environmental Protection,
Division of Air Quality

DATE: August 5, 2015

ATTN.: Director

Corporation's / other business entity's Federal Employer I.D. Number 46-5517375

The undersigned hereby files with the West Virginia Department of Environmental Protection, Division of Air Quality, a permit application and hereby certifies that the said name is a trade name which is used in the conduct of an incorporated business or other business entity.

Further, the corporation or the business entity certifies as follows:

(1) Luz Slauter and Barry Schatz (is/are) the authorized representative(s) and in that capacity may represent the interest of the corporation or the business entity and may obligate and legally bind the corporation or the business entity.

(2) The corporation or the business entity is authorized to do business in the State of West Virginia.

(3) If the corporation or the business entity changes its authorized representative(s), the corporation or the business entity shall notify the Director of the West Virginia Department of Environmental Protection, Division of Air Quality, immediately upon such change.

Ward McNeilly, Vice President - Vice President Reserves Planning & Midstream

President or Other Authorized Officer
(Vice President, Secretary, Treasurer or other official in charge of a principal business function of the corporation or the business entity)

(If not the President, then the corporation or the business entity must submit certified minutes or bylaws stating legal authority of other authorized officer to bind the corporation or the business entity).

Secretary

Antero Midstream LLC
Name of Corporation or business entity