

TABLE OF CONTENTS

TABLE OF CONTENTS.....	i
INTRODUCTION.....	1
Proposed Emissions	1
Regulatory Discussion	2
APPLICATION FOR GENERAL PERMIT REGISTRATION.....	6
ATTACHMENT A: SINGLE SOURCE DETERMINATION	9
ATTACHMENT C: BUSINESS REGISTRATION CERTIFICATE.....	12
ATTACHMENT D: PROCESS FLOW DIAGRAM	14
ATTACHMENT E: PROCESS DESCRIPTION	16
ATTACHMENT F: PLOT PLAN.....	17
ATTACHMENT G: AREA MAPS	19
ATTACHMENT H: G70-D SECTION APPLICABILITY FORM	22
ATTACHMENT I: EMISSIONS UNITS/ERD TABLE.....	24
ATTACHMENT J: FUGITIVE EMISSIONS SUMMARY SHEET	26
ATTACHMENT K: GAS WELL AFFECTED FACILITY DATA SHEET	30
ATTACHMENT L: STORAGE VESSELS DATA SHEET	32
ATTACHMENT M: NATURAL GAS FIRED FUEL BURNING UNITS DATA SHEET	41
ATTACHMENT N: INTERNAL COMBUSTION ENGINE DATA SHEETS	46
ATTACHMENT O: TANKER TRUCK LOADING DATA SHEET.....	60
ATTACHMENT Q: PNEUMATIC CONTROLLERS DATA SHEET	66
ATTACHMENT R: PNEUMATIC PUMP DATA SHEET.....	68
ATTACHMENT S: AIR POLLUTION CONTROL DEVICE/EMISSION REDUCTION DEVICES SHEETS.....	70

ATTACHMENT T: EMISSIONS CALCULATIONS.....	76
ATTACHMENT U: FACILITY-WIDE EMISSION SUMMARY SHEETS	115
ATTACHMENT V: LEGAL ADVERTISEMENT	118

INTRODUCTION

SWN Production Company, LLC (SWN), operates the Robert Bone Pad under Permit No. R13-2977B, issued on February 11, 2015. With this application, SWN requests authorization to add two 145-hp Caterpillar G3306 NA compressor engines, one 203-hp Caterpillar G3306 TA compressor engine, three GPU burners, two stabilizer heaters, six tanks, and one 24-mmBtu/hr vapor combustor with pilots and to remove one line heater and one 15-mmBtu/hr vapor combustor with pilot. Combustor controls have also been removed from the produced water loading. Tank throughputs and compositions have been updated and fugitive emissions have been revised to include four sand separators and three fuel gas separators. As a result of these changes, truck loading, vapor combustor, fugitive, and haul road emissions have also been updated. The change in emissions from this project are more than the construction levels; therefore, this project qualifies as a Modification. SWN also requests to operate under the General Permit G70-D for Oil and Natural Gas Production Facilities. Equipment to be authorized includes the following:

- Two (2) Caterpillar G3306 NA Compressor Engines
- One (1) Caterpillar G3306 TA Compressor Engine
- Four (4) Sand Separators (not an emissions source other than fugitive components)
- Three (3) Fuel Gas Separators (not an emissions source other than fugitive components)
- Four (4) 1.0-mmBtu/hr Gas Production Units
- Two (2) 1.5-mmBtu/hr Stabilizer Heaters
- Six (6) 400-bbl Condensate Tanks
- Six (6) 400-bbl Produced Water Tanks
- Condensate Truck Loading
- Produced Water Truck Loading
- One (1) 24.0-mmBtu/hr Vapor Combustor with Pilots
- Fugitive Emissions
- Fugitive Haul Road Emissions

Note that other small storage tanks may be present on site (i.e., methanol, lube oil) but are considered de minimis sources per Table 45-13B and are listed on the application form.

Proposed Emissions

Emissions calculations for the facility are presented in Attachment T. A fuel heating value of 905 Btu/scf was used to calculate emissions from natural gas-fired equipment. Actual heating value

may vary (generally 905 - 1,300) but using a lower heating value in the emissions calculations provides a more conservative (higher) estimate of fuel use.

Emissions from the Caterpillar engines were calculated with manufacturer data when available and AP-42/EPA emissions factors for the remaining pollutants.

Condensate and produced water tank emissions were calculated using ProMax process simulation software. Condensate and produced water tank emissions are routed to a vapor combustor with 100% capture efficiency and 98% destruction efficiency. Loading emissions were calculated using ProMax process simulation software and AP-42 calculations. Condensate loading emissions are routed to a vapor combustor with 70% capture efficiency and 98% destruction efficiency. Produced water loading emissions are vented to the atmosphere.

Fugitive emissions were calculated with a component count by equipment type from a similar facility, and representative extended gas and liquids analyses. Fugitive haul road emissions were calculated using EPA/AP-42 methodologies.

Greenhouse gas emissions were calculated with the latest EPA factors and manufacturer data when available. Documents used as references for the emissions calculations, including AP-42 and EPA emission factor references, gas and liquids analyses, and process simulation results are attached.

Regulatory Discussion

STATE

45 CSR 13 - PERMITS FOR CONSTRUCTION, MODIFICATION, RELOCATION AND OPERATION OF STATIONARY SOURCES OF AIR POLLUTANTS, NOTIFICATION REQUIREMENTS, ADMINISTRATIVE UPDATES, TEMPORARY PERMITS, GENERAL PERMITS, AND PROCEDURES FOR EVALUATION:

The facility requests to operate under the General Permit G70-D. Emissions of carbon monoxide and volatile organic compounds are less than 80 tons per year (TPY). Oxides of nitrogen emissions are less than 50 TPY and particulate matter 10/2.5 and sulfur dioxide emissions are each less than 20 TPY. Also, the facility will have less than 8 TPY for each hazardous air pollutant and less than 20 tons for total hazardous air pollutants. The change in emissions from this project are more than the construction levels; therefore, this project qualifies as a Modification.

45 CSR 22 - AIR QUALITY MANAGEMENT FEE PROGRAM:

The facility will be required to maintain a valid Certificate to Operate on the premises.

45 CSR 30 - REQUIREMENTS FOR OPERATING PERMITS:

Emissions from the facility do not exceed major source thresholds; therefore, this rule does not apply.

FEDERAL

40 CFR PART 60 SUBPART KB—STANDARDS OF PERFORMANCE FOR VOLATILE ORGANIC LIQUID STORAGE VESSELS (INCLUDING PETROLEUM LIQUID STORAGE VESSELS) FOR WHICH CONSTRUCTION, RECONSTRUCTION, OR MODIFICATION COMMENCED AFTER JULY 23, 1984

The affected facility to which this Subpart applies is each storage vessel with a capacity greater than or equal to 75 cubic meters (m³) that is used to store volatile organic liquids (VOL) for which construction, reconstruction, or modification is commenced after July 23, 1984. The tanks at this facility were constructed after the effective date of this Subpart but are less than 75 m³ (which equals approximately 471 bbl); therefore, this Subpart does not apply.

40 CFR PART 60 SUBPART KKK - STANDARDS OF PERFORMANCE FOR STATIONARY FOR EQUIPMENT LEAKS OF VOC FROM ONSHORE NATURAL GAS PROCESSING PLANTS:

The facility is not considered an affected source (natural gas processing plant) and is therefore not subject to this Subpart.

40 CFR PART 60 SUBPART IIII - STANDARDS OF PERFORMANCE FOR STATIONARY COMPRESSION IGNITION INTERNAL COMBUSTION ENGINES:

The facility does not contain the affected source (diesel-fired engine) and is therefore not subject to this Subpart.

40 CFR PART 60 SUBPART JJJJ - STANDARDS OF PERFORMANCE FOR STATIONARY SPARK IGNITION INTERNAL COMBUSTION ENGINES:

The proposed 145-hp and 203-hp, four-stroke, rich-burn natural gas-fired flash gas compressor engines are assumed to have been constructed after the June 12, 2006 effective date and manufactured after July 1, 2008; therefore, they will be subject to this Subpart. Although final selection of the engines has not yet been made, it is presumed that the engines were manufactured after January 1, 2011 and are therefore subject to the Stage 2 emission limitations under this Subpart. SWN will comply with all applicable requirements.

40 CFR PART 60 SUBPART OOOO - STANDARDS OF PERFORMANCE FOR CRUDE OIL AND NATURAL GAS PRODUCTION, TRANSMISSION, AND DISTRIBUTION:

The emission sources affected by this Subpart include well completions, pneumatic controllers, equipment leaks from natural gas processing plants, sweetening units at natural gas processing plants, reciprocating compressors, centrifugal compressors and storage vessels which are constructed, modified or reconstructed after August 23, 2011 and before September 18, 2015.

The one (1) existing well at this location was completed during the effective date of this Subpart and is subject to the compliance requirements. There is no centrifugal compressor using wet gas seals at this facility. The pneumatic controllers utilized at the facility are considered low-bleed and are not subject to this Subpart. The storage vessel venting is controlled to less than six (6) TPY VOC and federally enforceable limits are requested; therefore, the storage vessels are not subject to this Subpart.

40 CFR PART 60 SUBPART OOOOA - STANDARDS OF PERFORMANCE FOR CRUDE OIL AND NATURAL GAS FACILITIES FOR WHICH CONSTRUCTION, MODIFICATION, OR RECONSTRUCTION COMMENCED AFTER SEPTEMBER 18, 2015:

The emission sources affected by this Subpart include well completions, centrifugal compressors, reciprocating compressors, pneumatic controllers, storage vessels, fugitive sources at well sites, fugitive sources at compressor stations, pneumatic pumps, equipment leaks from natural gas processing plants and sweetening units at natural gas processing plants which are constructed, modified or reconstructed after September 18, 2015.

The three (3) proposed wells at this location will be completed after the effective date of this Subpart and will be subject to the compliance requirements. There is no centrifugal compressor using wet gas seals at this facility. The pneumatic controllers utilized at the facility are considered low-bleed and are not subject to this Subpart. The storage vessel venting is controlled to less than six (6) TPY VOC and federally enforceable limits are requested; therefore, the storage vessels are not subject to this Subpart. Reciprocating compressors located at well sites are not subject to this Subpart.

40 CFR PART 63 SUBPART HH - NATIONAL EMISSION STANDARDS FOR HAZARDOUS AIR POLLUTANTS FOR SOURCE CATEGORIES FROM OIL AND NATURAL GAS PRODUCTION FACILITIES:

The site is a minor (area) source of hazardous air pollutants. This Subpart applies to affected emission points that are located at facilities that are major and area sources of HAP, and either process, upgrade, or store hydrocarbon liquids prior to custody transfer or that process, upgrade, or store natural gas prior to entering the natural gas transmission and storage source category. For purposes of this Subpart natural gas enters the natural gas transmission and storage source

category after the natural gas processing plant, if present. The facility is a minor (area) source of HAP; however, there is no triethylene glycol (TEG) dehydration unit present at the facility and therefore this Subpart does not apply.

40 CFR PART 63 SUBPART HHH - NATIONAL EMISSION STANDARDS FOR HAZARDOUS AIR POLLUTANTS FOR SOURCE CATEGORIES FROM NATURAL TRANSMISSION AND STORAGE FACILITIES:

The facility is not a natural gas transmission and storage facility and is therefore not subject to this Subpart.

40 CFR PART 63 SUBPART ZZZZ - NATIONAL EMISSION STANDARDS FOR HAZARDOUS AIR POLLUTANTS FOR SOURCE CATEGORIES FROM STATIONARY RECIPROCATING INTERNAL COMBUSTION ENGINES - AREA SOURCE:

The original rule, published on February 26, 2004, initially affected new (constructed or reconstructed after December 19, 2002) reciprocating internal combustion engines (RICE) with a site-rating greater than 500 brake horsepower (HP) located at a major source of HAP emissions. On January 18, 2008, EPA published an amendment that promulgated standards for RICE constructed or reconstructed after June 12, 2006 with a site rating less than or equal to 500 HP located at major sources, and for engines constructed and reconstructed after June 12, 2006 located at area sources. On August 10, 2010, EPA published another amendment that promulgated standards for existing (constructed or reconstructed before June 12, 2006) RICE at area sources and existing RICE (constructed or reconstructed before June 12, 2006) with a site rating of less than or equal to 500 HP at major sources.

Owners and operators of new or reconstructed engines at area sources must meet the requirements of Subpart ZZZZ by complying with either 40 CFR Part 60 Subpart IIII (for CI engines) or 40 CFR Part 60 Subpart JJJJ (for SI engines). Based on emission calculations, this facility is a minor source of HAP. The proposed 145-hp and 203-hp, four-stroke, rich-burn natural gas-fired flash gas compressor engines are considered new engines manufactured after January 1, 2011 and will meet the requirements of this Subpart by complying with requirements under NSPS Subpart JJJJ.

APPLICATION FOR GENERAL PERMIT REGISTRATION



west virginia department of environmental protection

Division of Air Quality
601 57th Street SE
Charleston, WV 25 4
Phone (304) 926-0475
Fax (304) 926-0479
www.dep.wv.gov

G70-D GENERAL PERMIT REGISTRATION APPLICATION

PREVENTION AND CONTROL OF AIR POLLUTION IN REGARD TO THE CONSTRUCTION, MODIFICATION, RELOCATION, ADMINISTRATIVE UPDATE AND OPERATION OF NATURAL GAS PRODUCTION FACILITIES LOCATED AT THE WELL SITE

- | | |
|--|---|
| <input type="checkbox"/> CONSTRUCTION | <input type="checkbox"/> CLASS I ADMINISTRATIVE UPDATE |
| <input checked="" type="checkbox"/> MODIFICATION | <input type="checkbox"/> CLASS II ADMINISTRATIVE UPDATE |
| <input type="checkbox"/> RELOCATION | |

SECTION 1. GENERAL INFORMATION

Name of Applicant (as registered with the WV Secretary of State's Office): SWN Production Company, LLC

Federal Employer ID No. (FEIN): 26-4388727

Applicant's Mailing Address: 10000 Energy Drive

City: Spring

State: TX

ZIP Code: 77389

Facility Name: Robert Bone Pad

Operating Site Physical Address: 648 Paw Paw Ridge Lane
If none available, list road, city or town and zip of facility.

City: Wellsburg

Zip Code: 26070

County: Brooke

Latitude & Longitude Coordinates (NAD83, Decimal Degrees to 5 digits):

Latitude: 40.218919

Longitude: -80.601742

SIC Code: 1311

DAQ Facility ID No. (For existing facilities)

NAICS Code: 211111

009-00102

CERTIFICATION OF INFORMATION

This G70-D General Permit Registration Application shall be signed below by a Responsible Official. A Responsible Official is a President, Vice President, Secretary, Treasurer, General Partner, General Manager, a member of the Board of Directors, or Owner, depending on business structure. A business may certify an Authorized Representative who shall have authority to bind the Corporation, Partnership, Limited Liability Company, Association, Joint Venture or Sole Proprietorship. Required records of daily throughput, hours of operation and maintenance, general correspondence, compliance certifications and all required notifications must be signed by a Responsible Official or an Authorized Representative. If a business wishes to certify an Authorized Representative, the official agreement below shall be checked off and the appropriate names and signatures entered. **Any administratively incomplete or improperly signed or unsigned G70-D Registration Application will be returned to the applicant. Furthermore, if the G70-D forms are not utilized, the application will be returned to the applicant. No substitution of forms is allowed.**

I hereby certify that Clay Murral is an Authorized Representative and in that capacity shall represent the interest of the business (e.g., Corporation, Partnership, Limited Liability Company, Association Joint Venture or Sole Proprietorship) and may obligate and legally bind the business. If the business changes its Authorized Representative, a Responsible Official shall notify the Director of the Division of Air Quality immediately.

I hereby certify that all information contained in this G70-D General Permit Registration Application and any supporting documents appended hereto is, to the best of my knowledge, true, accurate and complete, and that all reasonable efforts have been made to provide the most comprehensive information possible.

Responsible Official Signature: _____

Name and Title:

Phone:

Fax:

Email:

Date:

If applicable:

Authorized Representative Signature: Clay Murral

Name and Title: Clay Murral, Regulatory Supervisor

Phone: 304-884-1715

Fax:

Email: Clay_Murral@SWN.com

Date: 12/18/2017

If applicable:

Environmental Contact

Name and Title: Heather Cready, Regulatory Technician

Phone: 304-884-1651

Fax:

Email: Heather_Cready@SWN.com

Date:

OPERATING SITE INFORMATION

Briefly describe the proposed new operation and/or any change(s) to the facility: This application includes two (2) Caterpillar G3306 NA engines (EU-ENG1 – EU-ENG2), one (1) Caterpillar G3306 TA engine (EU-ENG3), four (4) 1.0-mmBtu/hr natural gas-fired gas production unit (GPU) burners (EU-GPU1 – EU-GPU4), two (2) 1.5-mmBtu/hr natural gas-fired stabilizer heaters (EU-SH1 – EU-SH2), six (6) 400-bbl condensate tanks (EU-TANKS-COND), six (6) 400-bbl produced water tanks (EU-TANKS-PW), condensate and produced water truck loading (EU-LOAD-COND and EU-LOAD-PW), one (1) 24.0-mmBtu/hr vapor combustor (APC-COMB) with four (4) 50-SCFH pilots (EU-PILOTS), fugitive emissions (EU-FUG), and fugitive haul road emissions (EU-HR).

Directions to the facility: Travel north on SR 2 from Wheeling, WV to just south of the community of Wellsburg, WV. Turn right onto CR 67(Bethany Pike) south of Wellsburg and travel east 4.5 miles to CR 30 (Hukill Run road). Turn right onto CR 30 and travel approximately 0.7 miles to access road on the right.

ATTACHMENTS AND SUPPORTING DOCUMENTS

I have enclosed the following required documents:

Check payable to WVDEP – Division of Air Quality with the appropriate application fee (per 45CSR13 and 45CSR22).

- Check attached to front of application.
- I wish to pay by electronic transfer. Contact for payment (incl. name and email address):
- I wish to pay by credit card. Contact for payment (incl. name and email address):
- \$500 (Construction, Modification, and Relocation) \$300 (Class II Administrative Update)
- \$1,000 NSPS fee for 40 CFR60, Subpart IIII, JJJJ, OOOO and/or OOOOa ¹
- \$2,500 NESHAP fee for 40 CFR63, Subpart ZZZZ and/or HH ²

¹ Only one NSPS fee will apply.
² Only one NESHAP fee will apply. The Subpart ZZZZ NESHAP fee will be waived for new engines that satisfy requirements by complying with NSPS, Subparts IIII and/or JJJJ.
NSPS and NESHAP fees apply to new construction or if the source is being modified.

- Responsible Official or Authorized Representative Signature (if applicable)
- Single Source Determination Form (**must be completed**) – Attachment A
- Siting Criteria Waiver (if applicable) – Attachment B Current Business Certificate – Attachment C
- Process Flow Diagram – Attachment D Process Description – Attachment E
- Plot Plan – Attachment F Area Map – Attachment G
- G70-D Section Applicability Form – Attachment H Emission Units/ERD Table – Attachment I
- Fugitive Emissions Summary Sheet – Attachment J
- Gas Well Affected Facility Data Sheet (if applicable) – Attachment K
- Storage Vessel(s) Data Sheet (include gas sample data, USEPA Tanks, simulation software (e.g. ProMax, E&P Tanks, HYSYS, etc.), etc. where applicable) – Attachment L
- Natural Gas Fired Fuel Burning Unit(s) Data Sheet (GPU's, Heater Treaters, In-Line Heaters if applicable) – Attachment M
- Internal Combustion Engine Data Sheet(s) (include manufacturer performance data sheet(s) if applicable) – Attachment N
- Tanker Truck/Rail Car Loading Data Sheet (if applicable) – Attachment O
- Glycol Dehydration Unit Data Sheet(s) (include wet gas analysis, GRI- GLYCalc™ input and output reports and information on reboiler if applicable) – Attachment P
- Pneumatic Controllers Data Sheet – Attachment Q
- Pneumatic Pump Data Sheet – Attachment R
- Air Pollution Control Device/Emission Reduction Device(s) Sheet(s) (include manufacturer performance data sheet(s) if applicable) – Attachment S
- Emission Calculations (please be specific and include all calculation methodologies used) – Attachment T
- Facility-wide Emission Summary Sheet(s) – Attachment U
- Class I Legal Advertisement – Attachment V
- One (1) paper copy and two (2) copies of CD or DVD with pdf copy of application and attachments

All attachments must be identified by name, divided into sections, and submitted in order.

ATTACHMENT A: SINGLE SOURCE DETERMINATION

ATTACHMENT A - SINGLE SOURCE DETERMINATION FORM

Classifying multiple facilities as one “stationary source” under 45CSR13, 45CSR14, and 45CSR19 is based on the definition of Building, structure, facility, or installation as given in §45-14-2.13 and §45-19-2.12. The definition states:

“Building, Structure, Facility, or Installation” means all of the pollutant-emitting activities which belong to the same industrial grouping, are located on one or more contiguous or adjacent properties, and are under the control of the same person (or persons under common control). Pollutant-emitting activities are a part of the same industrial grouping if they belong to the same “Major Group” (i.e., which have the same two (2)-digit code) as described in the Standard Industrial Classification Manual, 1987 (United States Government Printing Office stock number GPO 1987 0-185-718:QL 3).

The Source Determination Rule for the oil and gas industry was published in the Federal Register on June 3, 2016 and will become effective on August 2, 2016. EPA defined the term “adjacent” and stated that equipment and activities in the oil and gas sector that are under common control will be considered part of the same source if they are located on the same site or on sites that share equipment and are within ¼ mile of each other.

Is there equipment and activities in the same industrial grouping (defined by SIC code)?

Yes No

Is there equipment and activities under the control of the same person/people?

Yes No









Is there equipment and activities located on the same site or on sites that share equipment and are within ¼ mile of each other?

Yes No

Proximity Map



Robert Bone Pad
 Lease Road: 3,722.37 Feet
 NAD83 UTM Zone 17N
 533.832 4,452.137 Kilometers
 -80.601742 40.218919 Decimal Degrees

-  Schools
-  Residential Structures
-  Rivers and Lakes
-  Bone_300FT
-  Bone_Quarter_Mile
-  Compressor Stations
-  Processing Plant
-  Power Plant
-  Hospital

ATTACHMENT C: BUSINESS REGISTRATION CERTIFICATE

**WEST VIRGINIA
STATE TAX DEPARTMENT
BUSINESS REGISTRATION
CERTIFICATE**

ISSUED TO:
**SWN PRODUCTION COMPANY, LLC
5400D BIG TYLER RD
CHARLESTON, WV 25313-1103**

BUSINESS REGISTRATION ACCOUNT NUMBER: **2307-3731**

This certificate is issued on: **12/8/2014**

This certificate is issued by **[Signature]**
the West Virginia State Tax Commissioner,
in accordance with Chapter 11, Article 12, of the West Virginia Code.

The person or organization identified on this certificate is registered
to conduct business in the State of West Virginia at the location above.

This certificate is not transferrable and must be displayed at the location for which issued.

This certificate shall be permanent until cessation of the business for which the certificate of registration
was granted, or until it is suspended, revoked or cancelled by the Tax Commissioner.

Change in name or change of location shall be considered a cessation of the business and a new
certificate shall be required.

TRAVELING/STREET VENDORS: Must carry a copy of this certificate in every vehicle operated by them.
CONTRACTORS, DRILLING OPERATORS, TIMBER/LOGGING OPERATIONS: Must have a copy of
this certificate displayed at every job site within West Virginia.

atL006 v.4
L1180094016

ATTACHMENT D: PROCESS FLOW DIAGRAM

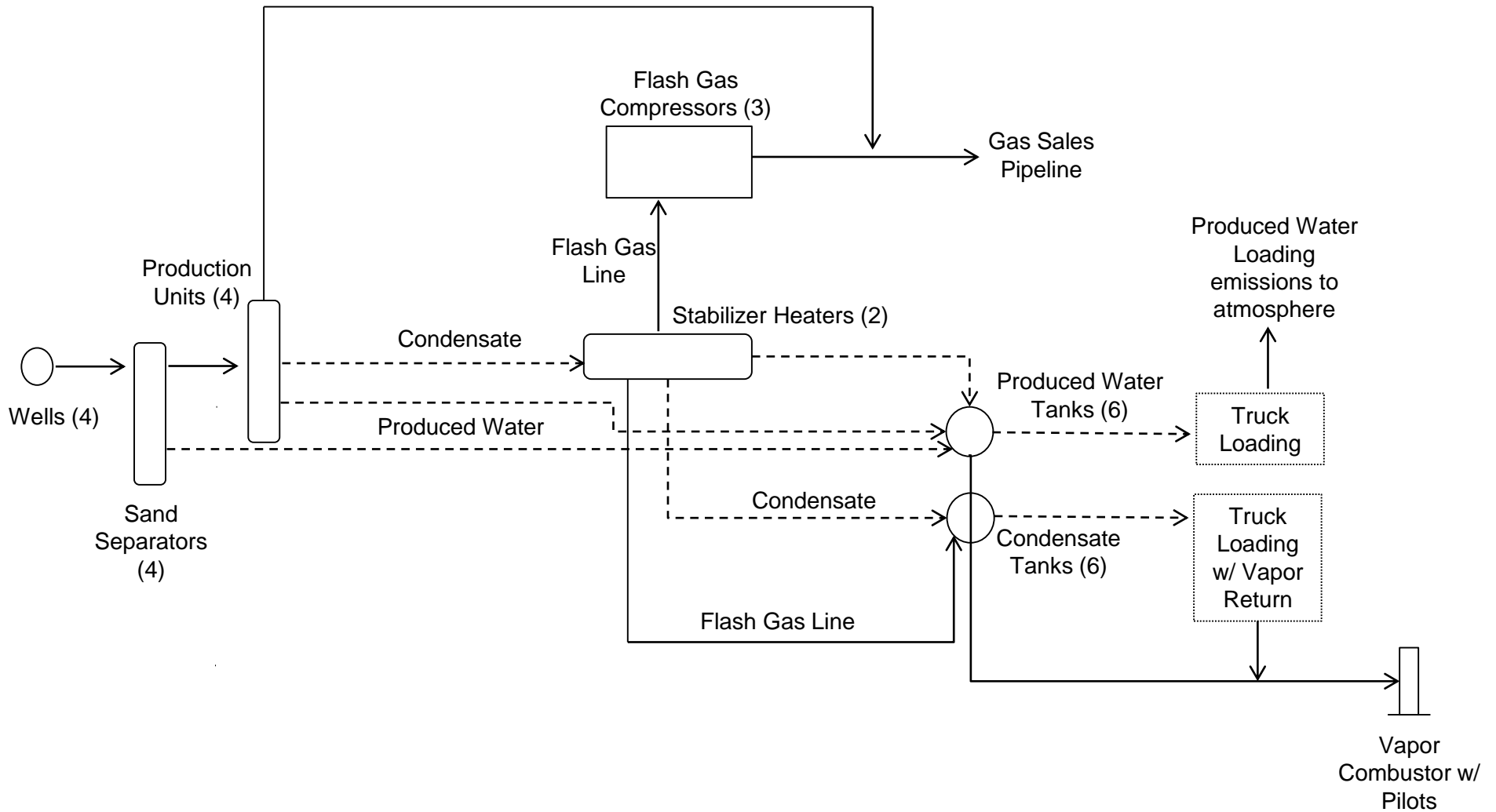

———— Gas/Vapor
 - - - - - Liquids (Condensate and Produced Water)

SWN Production Company, LLC
Robert Bone Pad
 Attachment D: Process Flow Diagram
 December 2017

Note: Drawing is a depiction of general facility process and is not intended to represent facility and/or equipment layout.

ATTACHMENT E: PROCESS DESCRIPTION

The facility is an oil and natural gas exploration and production facility, responsible for the production of condensate and natural gas. Storage of condensate and produced water also occurs on-site. A description of the facility process is as follows: Condensate, gas and water come from the wellheads through the sand separators then to the production units, where the first stage of separation occurs. Produced water is sent from the production units to the produced water tanks. Condensate and residual water are sent to the stabilizer heaters. The flash from the stabilizer heaters is captured via natural gas-fired engine-driven flash gas compressors. Produced water from the stabilizer heaters flows into the produced water storage tanks. Condensate flows into the condensate storage tanks.

The natural gas stream exits the facility for transmission via pipeline. Condensate and produced water are transported offsite via truck. Working, breathing and flashing vapors from the condensate and produced water tanks are routed to the vapor combustor with 100% capture efficiency to be burned with at least 98% combustion efficiency. Condensate loading emissions are routed to a vapor combustor with 70% capture efficiency and 98% destruction efficiency. Produced water loading emissions are vented to the atmosphere. The vapor combustor has four (4) natural gas-fired pilots to ensure a constant flame for combustion.

A process flow diagram reflecting facility operations is shown in Attachment D.

ATTACHMENT F: PLOT PLAN

Please note that the simple plot plan provided is only a representation of production/emissions equipment to be installed. Actual location specifications and equipment placement are not to scale.

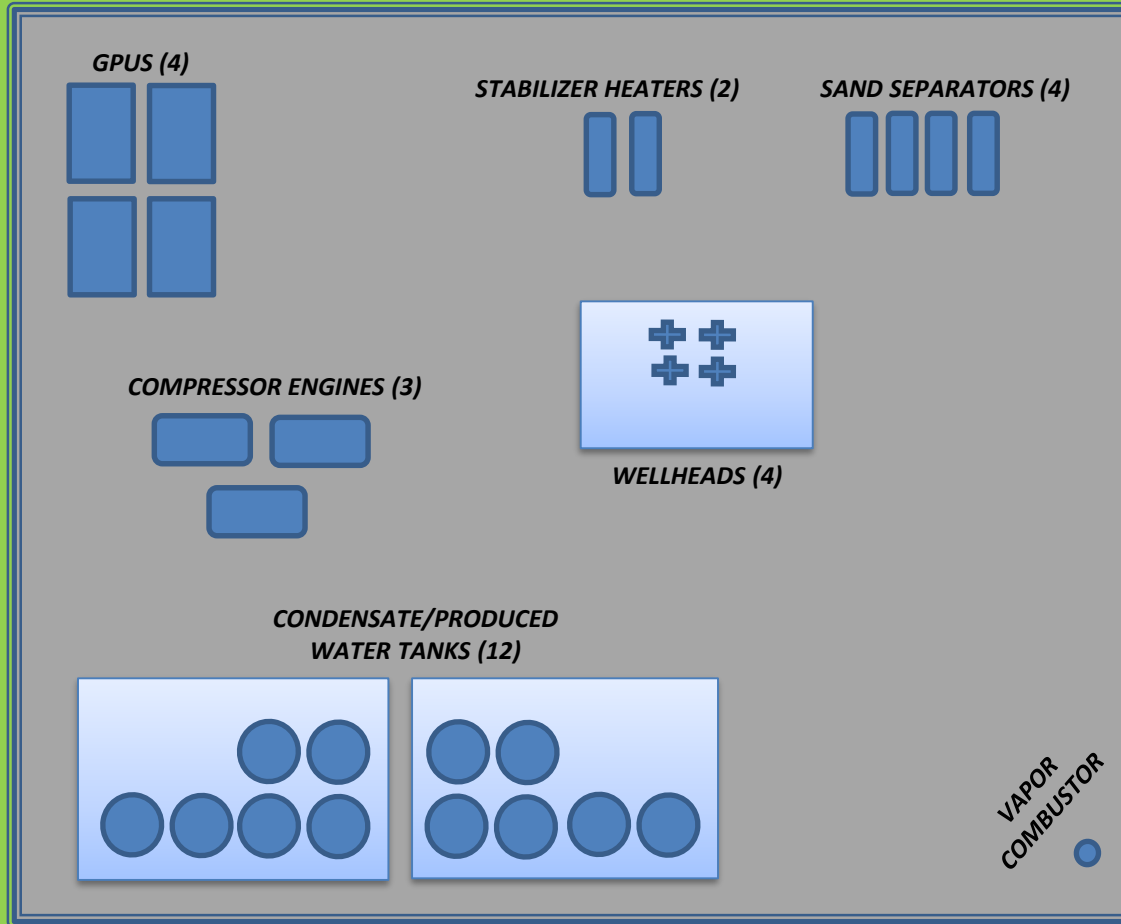

NOTE: Image is only a representation of production/emissions equipment. Actual location specifications and equipment placement are not to scale.

ATTACHMENT G: AREA MAPS



Data use subject to license.
© DeLorme XMap® 7.
www.delorme.com

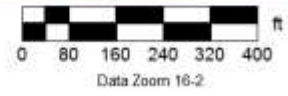

SWN Production Company, LLC
Robert Bone Pad
Attachment G: Area Map with 300' Radius
December 2017

ATTACHMENT H: G70-D SECTION APPLICABILITY FORM

ATTACHMENT H – G70-D SECTION APPLICABILITY FORM

**General Permit G70-D Registration
Section Applicability Form**

General Permit G70-D was developed to allow qualified applicants to seek registration for a variety of sources. These sources include gas well affected facilities, storage vessels, gas production units, in-line heaters, heater treaters, glycol dehydration units and associated reboilers, pneumatic controllers, pneumatic pumps, reciprocating internal combustion engines (RICEs), tank truck/rail car loading, fugitive emissions, completion combustion devices, flares, enclosed combustion devices, and vapor recovery systems. All registered facilities will be subject to Sections 1.0, 2.0, 3.0, and 4.0.

General Permit G70-D allows the registrant to choose which sections of the permit they are seeking registration under. Therefore, please mark which additional sections that you are applying for registration under. If the applicant is seeking registration under multiple sections, please select all that apply. Please keep in mind, that if this registration is approved, the issued registration will state which sections will apply to your affected facility.

GENERAL PERMIT G70-D APPLICABLE SECTIONS	
<input checked="" type="checkbox"/> Section 5.0	Gas and Oil Well Affected Facility (NSPS, Subpart OOOO/OOOOa)
<input checked="" type="checkbox"/> Section 6.0	Storage Vessels Containing Condensate and/or Produced Water ¹
<input type="checkbox"/> Section 7.0	Storage Vessel Affected Facility (NSPS, Subpart OOOO/OOOOa)
<input checked="" type="checkbox"/> Section 8.0	Control Devices and Emission Reduction Devices not subject to NSPS Subpart OOOO/OOOOa and/or NESHAP Subpart HH
<input checked="" type="checkbox"/> Section 9.0	Small Heaters and Reboilers not subject to 40CFR60 Subpart Dc
<input type="checkbox"/> Section 10.0	Pneumatic Controllers Affected Facility (NSPS, Subpart OOOO/OOOOa)
<input type="checkbox"/> Section 11.0	Pneumatic Pump Affected Facility (NSPS, Subpart OOOOa)
<input type="checkbox"/> Section 12.0	Fugitive Emissions GHG and VOC Standards (NSPS, Subpart OOOOa)
<input checked="" type="checkbox"/> Section 13.0	Reciprocating Internal Combustion Engines, Generator Engines
<input checked="" type="checkbox"/> Section 14.0	Tanker Truck/Rail Car Loading ²
<input type="checkbox"/> Section 15.0	Glycol Dehydration Units ³

- 1 Applicants that are subject to Section 6 may also be subject to Section 7 if the applicant is subject to the NSPS, Subparts OOOO or OOOOa control requirements or the applicable control device requirements of Section 8.
- 2 Applicants that are subject to Section 14 may also be subject to control device and emission reduction device requirements of Section 8.
- 3 Applicants that are subject to Section 15 may also be subject to the requirements of Section 9 (reboilers). Applicants that are subject to Section 15 may also be subject to control device and emission reduction device requirements of Section 8.

ATTACHMENT I: EMISSIONS UNITS/ERD TABLE

ATTACHMENT I - EMISSION UNITS/EMISSION REDUCTION DEVICES (ERD) TABLE

Include ALL emission units and air pollution control devices/ERDs that will be part of this permit application review. Do not include fugitive emission sources in this table. Deminimis storage tanks shall be listed in the Attachment L table. This information is required for all sources regardless of whether it is a construction, modification, or administrative update.

Emission Unit ID ¹	Emission Point ID ²	Emission Unit Description	Year Installed	Manufac. Date ³	Design Capacity	Type ⁴ and Date of Change	Control Device(s) ⁵	ERD(s) ⁶
EU-ENG1	EP-ENG1	145-hp Caterpillar G3306 NA Engine	TBD	after 1/1/2011	145-hp	New	NSCR	NSCR
EU-ENG2	EP-ENG2	145-hp Caterpillar G3306 NA Engine	TBD	after 1/1/2011	145-hp	New	NSCR	NSCR
EU-ENG3	EP-ENG3	203-hp Caterpillar G3306 TA Engine	TBD	after 1/1/2011	203-hp	New	NSCR	NSCR
EU-GPU1	EP-GPU1	1.0-mmBtu/hr GPU Burner	2013	N/A	1.0-mmBtu/hr	Existing	N/A	N/A
EU-GPU2	EP-GPU2	1.0-mmBtu/hr GPU Burner	TBD	N/A	1.0-mmBtu/hr	New	N/A	N/A
EU-GPU3	EP-GPU3	1.0-mmBtu/hr GPU Burner	TBD	N/A	1.0-mmBtu/hr	New	N/A	N/A
EU-GPU4	EP-GPU4	1.0-mmBtu/hr GPU Burner	TBD	N/A	1.0-mmBtu/hr	New	N/A	N/A
EU-LH1	EP-LH1	1.5-mmBtu/hr Line Heater	N/A	N/A	1.5-mmBtu/hr	Removal	N/A	N/A
EU-SH1	EP-SH1	1.5-mmBtu/hr Stabilizer Heater	TBD	N/A	1.5-mmBtu/hr	New	N/A	N/A
EU-SH2	EP-SH2	1.5-mmBtu/hr Stabilizer Heater	TBD	N/A	1.5-mmBtu/hr	New	N/A	N/A
EU-TANKS-COND	APC-COMB	Six (6) 400-bbl Condensate Tanks Routed to Vapor Combustor	3 - 2013; 3 - TBD	N/A	400-bbl	Modification	APC-COMB	APC-COMB
EU-TANKS-PW	APC-COMB	Six (6) 400-bbl Produced Water Tanks Routed to Vapor Combustor	3 - 2013; 3 - TBD	N/A	400-bbl	Modification	APC-COMB	APC-COMB
EU-LOAD-COND	EU-LOAD-COND and APC-COMB	Condensate Truck Loading w/ Vapor Return Routed to Combustor	2013	N/A	27,307,329 gal/yr	Modification	Vapor Return and APC-COMB	Vapor Return and APC-COMB
EU-LOAD-PW	EP-LOAD-PW	Produced Water Truck Loading	2013	N/A	27,488,223 gal/yr	Modification	N/A	N/A
APC-COMB	APC-COMB	24.0-mmBtu/hr Vapor Combustor	TBD	N/A	24.0-mmBtu/hr	New	N/A	N/A
EU-PILOTS	APC-COMB	Vapor Combustor Pilots	TBD	N/A	200-scfh	New	N/A	N/A
APC-COMB-TKLD	APC-COMB-TKLD	15.0-mmBtu/hr Vapor Combustor	2013	N/A	15-mmBtu/hr	Removal	N/A	N/A
EU-PILOT	APC-COMB-TKLD	Vapor Combustor Pilot	2013	N/A	50-scfh	Removal	N/A	N/A
EU-FUG	EP-FUG	Fugitive Emissions	2013	N/A	N/A	Modification	N/A	N/A
EU-HR	EP-HR	Fugitive Haul Road Emissions	2013	N/A	N/A	Modification	N/A	N/A

¹ For Emission Units (or Sources) use the following numbering system: 1S, 2S, 3S,... or other appropriate designation.

² For Emission Points use the following numbering system: 1E, 2E, 3E, ... or other appropriate designation.

³ When required by rule

⁴ New, modification, removal, existing

⁵ For Control Devices use the following numbering system: 1C, 2C, 3C,... or other appropriate designation.

⁶ For ERDs use the following numbering system: 1D, 2D, 3D,... or other appropriate designation.

ATTACHMENT J: FUGITIVE EMISSIONS SUMMARY SHEET

Fugitive emissions at this site consist of haul road emissions, condensate and produced water loading operations, and equipment leaks.

ATTACHMENT J – FUGITIVE EMISSIONS SUMMARY SHEET

Sources of fugitive emissions may include loading operations, equipment leaks, blowdown emissions, etc.
Use extra pages for each associated source or equipment if necessary.

Source/Equipment: EU-FUG

Leak Detection Method Used		<input type="checkbox"/> Audible, visual, and olfactory (AVO) inspections	<input type="checkbox"/> Infrared (FLIR) cameras	<input type="checkbox"/> Other (please describe)	<input checked="" type="checkbox"/> None required		
Component Type	Closed Vent System	Count	Source of Leak Factors (EPA, other (specify))	Stream type (gas, liquid, etc.)	Estimated Emissions (tpy)		
					VOC	HAP	GHG (methane, CO _{2e})
Pumps	<input type="checkbox"/> Yes <input type="checkbox"/> No			<input type="checkbox"/> Gas <input type="checkbox"/> Liquid <input type="checkbox"/> Both			
Valves	<input type="checkbox"/> Yes <input checked="" type="checkbox"/> No	79 – gas 178 – LL	EPA	<input type="checkbox"/> Gas <input type="checkbox"/> Liquid <input checked="" type="checkbox"/> Both	0.79 – gas 4.10 – LL	0.01 – gas 0.28 – LL	44.36 – gas 1.09 – LL
Safety Relief Valves	<input type="checkbox"/> Yes <input checked="" type="checkbox"/> No	58	EPA	<input checked="" type="checkbox"/> Gas <input type="checkbox"/> Liquid <input type="checkbox"/> Both	1.14	0.01	63.69
Open Ended Lines	<input type="checkbox"/> Yes <input type="checkbox"/> No			<input type="checkbox"/> Gas <input type="checkbox"/> Liquid <input type="checkbox"/> Both			
Sampling Connections	<input type="checkbox"/> Yes <input type="checkbox"/> No			<input type="checkbox"/> Gas <input type="checkbox"/> Liquid <input type="checkbox"/> Both			
Connections (Not sampling)	<input type="checkbox"/> Yes <input checked="" type="checkbox"/> No	622	EPA	<input type="checkbox"/> Gas <input checked="" type="checkbox"/> Liquid <input type="checkbox"/> Both	1.20	0.08	0.32
Compressors	<input type="checkbox"/> Yes <input checked="" type="checkbox"/> No	9	EPA	<input checked="" type="checkbox"/> Gas <input type="checkbox"/> Liquid <input type="checkbox"/> Both	0.18	<0.01	9.88
Flanges	<input type="checkbox"/> Yes <input checked="" type="checkbox"/> No	363 – gas 42 – LL	EPA	<input type="checkbox"/> Gas <input type="checkbox"/> Liquid <input checked="" type="checkbox"/> Both	0.32 – gas 0.04 – LL	<0.01 – gas <0.01 – LL	17.67 – gas 0.01 – LL
Other ¹	<input type="checkbox"/> Yes <input checked="" type="checkbox"/> No	7	EPA	<input type="checkbox"/> Gas <input checked="" type="checkbox"/> Liquid <input type="checkbox"/> Both	<0.01	<0.01	<0.01

¹ Other equipment types may include compressor seals, relief valves, diaphragms, drains, meters, etc.

Please provide an explanation of the sources of fugitive emissions (e.g. pigging operations, equipment blowdowns, pneumatic controllers, etc.):
Equipment leaks

Please indicate if there are any closed vent bypasses (include component):

N/A

Specify all equipment used in the closed vent system (e.g. VRU, ERD, thief hatches, tanker truck/rail car loading, etc.)

N/A

TABLE 2-4. OIL AND GAS PRODUCTION OPERATIONS AVERAGE EMISSION FACTORS (kg/hr/source)

Equipment Type	Service ^a	Emission Factor (kg/hr/source) ^b
Valves	Gas	4.5E-03
	Heavy Oil	8.4E-06
	Light Oil	2.5E-03
	Water/Oil	9.8E-05
Pump seals	Gas	2.4E-03
	Heavy Oil	NA
	Light Oil	1.3E-02
	Water/Oil	2.4E-05
Others ^c	Gas	8.8E-03
	Heavy Oil	3.2E-05
	Light Oil	7.5E-03
	Water/Oil	1.4E-02
Connectors	Gas	2.0E-04
	Heavy Oil	7.5E-06
	Light Oil	2.1E-04
	Water/Oil	1.1E-04
Flanges	Gas	3.9E-04
	Heavy Oil	3.9E-07
	Light Oil	1.1E-04
	Water/Oil	2.9E-06
Open-ended lines	Gas	2.0E-03
	Heavy Oil	1.4E-04
	Light Oil	1.4E-03
	Water/Oil	2.5E-04

^aWater/Oil emission factors apply to water streams in oil service with a water content greater than 50%, from the point of origin to the point where the water content reaches 99%. For water streams with a water content greater than 99%, the emission rate is considered negligible.

^bThese factors are for total organic compound emission rates (including non-VOC's such as methane and ethane) and apply to light crude, heavy crude, gas plant, gas production, and off shore facilities. "NA" indicates that not enough data were available to develop the indicated emission factor.

^cThe "other" equipment type was derived from compressors, diaphragms, drains, dump arms, hatches, instruments, meters, pressure relief valves, polished rods, relief valves, and vents. This "other" equipment type should be applied for any equipment type other than connectors, flanges, open-ended lines, pumps, or valves.

ATTACHMENT K: GAS WELL AFFECTED FACILITY DATA SHEET

ATTACHMENT K – GAS WELL AFFECTED FACILITY DATA SHEET

Complete this data sheet if you are the owner or operator of a gas well affected facility for which construction, modification or reconstruction commenced after August 23, 2011. This form must be completed for natural gas well affected facilities regardless of when flowback operations occur (or have occurred).

API Number	Date of Flowback	Date of Well Completion	Green Completion and/or Combustion Device	Subject to OOOO or OOOOa?
047-009-00104 (3H)	2/6/2013	7/15/2012	Green Completion	OOOO
PLANNED	TBD	TBD	Green Completion	OOOOa
PLANNED	TBD	TBD	Green Completion	OOOOa
PLANNED	TBD	TBD	Green Completion	OOOOa

Note: If future wells are planned and no API number is available please list as PLANNED. If there are existing wells that commenced construction prior to August 23, 2011, please acknowledge as existing.

This is the same API (American Petroleum Institute) well number(s) provided in the well completion notification and as provided to the WVDEP, Office of Oil and Gas for the well permit. The API number may be provided on the application without the state code (047).

Every oil and gas well permitted in West Virginia since 1929 has been issued an API number. This API is used by agencies to identify and track oil and gas wells.

The API number has the following format: 047-001-00001

Where,
 047 = *State code. The state code for WV is 047.*
 001 = *County Code. County codes are odd numbers, beginning with 001 (Barbour) and continuing to 109 (Wyoming).*
 00001 = *Well number. Each well will have a unique well number.*

ATTACHMENT L: STORAGE VESSELS DATA SHEET

PROMAX PROCESS SIMULATION RESULTS
REPRESENTATIVE GAS AND LIQUID ANALYSES

ATTACHMENT L – STORAGE VESSEL DATA SHEET

Complete this data sheet if you are the owner or operator of a storage vessel that contains condensate and/or produced water. This form must be completed for *each* new or modified bulk liquid storage vessel(s) that contains condensate and/or produced water. (If you have more than one (1) identical tank (i.e. 4-400 bbl condensate tanks), then you can list all on one (1) data sheet). **Include gas sample analysis, flashing emissions, working and breathing losses, USEPA Tanks, simulation software (ProMax, E&P Tanks, HYSYS, etc.), and any other supporting documents where applicable.**

The following information is REQUIRED:

- Composition of the representative sample used for the simulation
- For each stream that contributes to flashing emissions:
 - Temperature and pressure (inlet and outlet from separator(s))
 - Simulation-predicted composition
 - Molecular weight
 - Flow rate
- Resulting flash emission factor or flashing emissions from simulation
- Working/breathing loss emissions from tanks and/or loading emissions if simulation is used to quantify those emissions

Additional information may be requested if necessary.

GENERAL INFORMATION (REQUIRED)

1. Bulk Storage Area Name Condensate Storage	2. Tank Name Six (6) 400-bbl Condensate Storage Tanks
3. Emission Unit ID number EU-TANKS-COND	4. Emission Point ID number APC-COMB
5. Date Installed, Modified or Relocated (<i>for existing tanks</i>) 3 – 2013; 3 - TBD Was the tank manufactured after August 23, 2011 and on or before September 18, 2015? <input checked="" type="checkbox"/> Yes <input type="checkbox"/> No Was the tank manufactured after September 18, 2015? <input checked="" type="checkbox"/> Yes <input type="checkbox"/> No	6. Type of change: <input checked="" type="checkbox"/> New construction <input type="checkbox"/> New stored material <input checked="" type="checkbox"/> Other <input type="checkbox"/> Relocation
7A. Description of Tank Modification (<i>if applicable</i>) Update quantity of tanks, composition, and throughput.	
7B. Will more than one material be stored in this tank? <i>If so, a separate form must be completed for each material.</i> <input type="checkbox"/> Yes <input checked="" type="checkbox"/> No	
7C. Was USEPA Tanks simulation software utilized? <input type="checkbox"/> Yes <input checked="" type="checkbox"/> No	
<i>If Yes, please provide the appropriate documentation and items 8-42 below are not required.</i>	

1. Bulk Storage Area Name Produced Water Storage	2. Tank Name Six (6) 400-bbl Produced Water Storage Tanks
3. Emission Unit ID number EU-TANKS-PW	4. Emission Point ID number APC-COMB
5. Date Installed, Modified or Relocated (<i>for existing tanks</i>) 3 – 2013; 3 - TBD Was the tank manufactured after August 23, 2011 and on or before September 18, 2015? <input checked="" type="checkbox"/> Yes <input type="checkbox"/> No Was the tank manufactured after September 18, 2015? <input checked="" type="checkbox"/> Yes <input type="checkbox"/> No	6. Type of change: <input checked="" type="checkbox"/> New construction <input type="checkbox"/> New stored material <input checked="" type="checkbox"/> Other <input type="checkbox"/> Relocation
7A. Description of Tank Modification (<i>if applicable</i>) Update quantity of tanks, composition, and throughput.	
7B. Will more than one material be stored in this tank? <i>If so, a separate form must be completed for each material.</i> <input type="checkbox"/> Yes <input checked="" type="checkbox"/> No	
7C. Was USEPA Tanks simulation software utilized? <input type="checkbox"/> Yes <input checked="" type="checkbox"/> No <i>If Yes, please provide the appropriate documentation and items 8-42 below are not required.</i>	

STORAGE TANK DATA TABLE

List all deminimis storage tanks (i.e. lube oil, glycol, diesel etc.)

Source ID # ¹	Status ²	Content ³	Volume ⁴
EU-TANKS-LUBEOIL	NEW	Lube Oil	50 gal
EU-TANKS-LUBEOIL	NEW	Lube Oil	50 gal
EU-TANKS-LUBEOIL	NEW	Lube Oil	50 gal
EU-TANKS-METHANOL	NEW	Methanol	50 gal
EU-TANKS-METHANOL	NEW	Methanol	50 gal
EU-TANKS-METHANOL	NEW	Methanol	50 gal
EU-TANKS-METHANOL	NEW	Methanol	50 gal
EU-TANKS-METHANOL	NEW	Methanol	50 gal
EU-TANKS-METHANOL	NEW	Methanol	50 gal
EU-TANKS-METHANOL	EXIST	Methanol	50 gal

- Enter the appropriate Source Identification Numbers (Source ID #) for each storage tank located at the well site. Tanks should be designated T01, T02, T03, etc.
- Enter storage tank Status using the following:

EXIST	Existing Equipment
NEW	Installation of New Equipment
REM	Equipment Removed
- Enter storage tank content such as condensate, pipeline liquids, glycol (DEG or TEG), lube oil, diesel, mercaptan etc.
- Enter the maximum design storage tank volume in gallons.

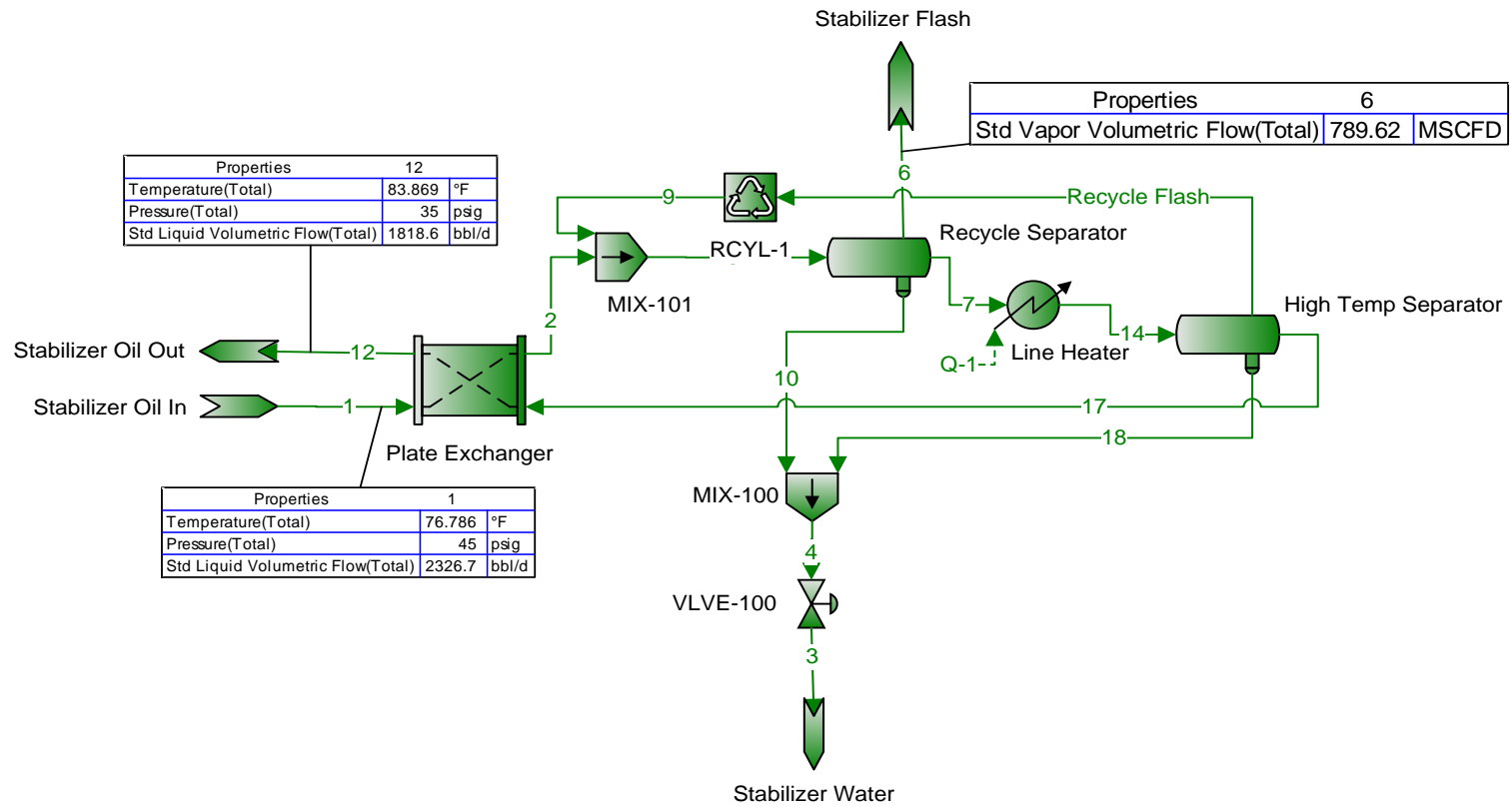

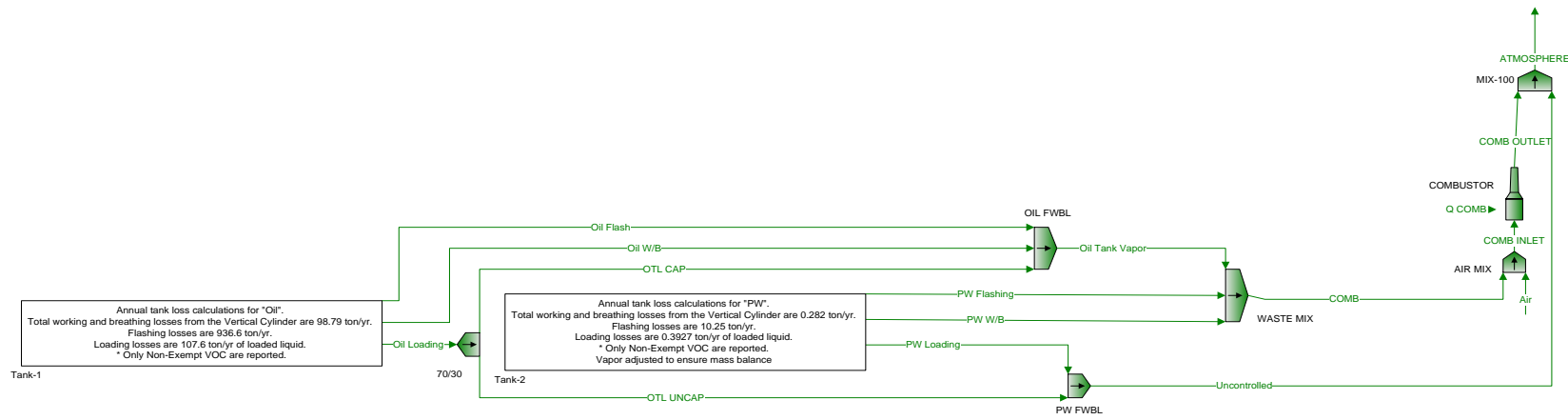

PStreams "Oil Vapor"/"Oil Out" Entire Vapor Stream EF= 46.43 SCF/bbl

PStreams "Oil Vapor"/"Oil Out" VOCs EF= 5.827 lb/bbl

PStreams "PW Vapor"/"Water Out" Entire Vapor Stream EF= 3.402 SCF/bbl

PStreams "PW Vapor"/"Water Out" VOCs EF= 0.03137 lb/bbl

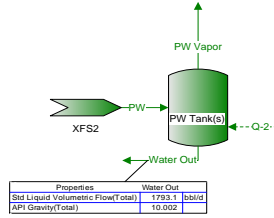
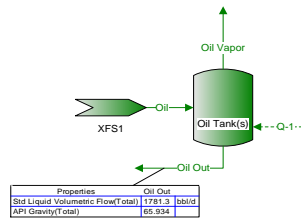

Combustor MDHI = 24 MMBtu/h

Max. Incineration Capacity = 226.5 lb/hr

"COMB INLET" Select sum = 937.2 lb/h

"COMB INLET" Select sum = 0.915 MMSCFD

"ATMOSPHERE" VOCs = 55.1 ton/yr

"COMB INLET" VOCs = 1,121 ton/yr

"Uncontrolled" VOCs = 32.68 ton/yr

Process Streams		Oil Flash	Oil Loading	Oil W/B	PW Flashing	PW Loading	PW W/B
Composition	Status:	Solved	Solved	Solved	Solved	Solved	Solved
Phase: Total	From Block:	--	--	--	--	--	--
	To Block:	OIL FWBL	70/30	OIL FWBL	WASTE MIX	PW FWBL	WASTE MIX
Mass Flow		lb/h	lb/h	lb/h	lb/h	lb/h	lb/h
H2S		0*	0*	0*	0*	0*	0*
N2		0.00218085*	1.55636E-05*	1.42875E-05*	0.0472119*	0.000648163*	0.000465443*
CO2		0.0852711*	0.00924215*	0.00848442*	0.337530*	0.185696*	0.133347*
C1		2.24984*	0.0672187*	0.0617077*	7.14114*	0.201509*	0.144703*
C2		30.0382*	4.49913*	4.13026*	4.10667*	0.167784*	0.120485*
C3		79.4002*	9.69877*	8.90360*	1.57469*	0.0451972*	0.0324559*
iC4		17.1255*	1.94761*	1.78793*	0.106160*	0.00204098*	0.00146562*
nC4		62.2482*	7.09649*	6.51467*	0.474389*	0.0125121*	0.00898487*
2,2-Dimethylbutane		0.0621470*	0.00675597*	0.00620207*	8.58852E-05*	5.62465E-07*	4.03903E-07*
iC5		13.5272*	1.48314*	1.36154*	0.0532300*	0.000964841*	0.000692847*
nC5		22.1162*	2.38134*	2.18610*	0.0418480*	0.000321222*	0.000230668*
2,2-Dimethylpropane		0.524569*	0.0579147*	0.0531665*	0.00153461*	1.84675E-05*	1.32614E-05*
Cyclopentane		0.0396343*	0.00379920*	0.00348772*	0.000750971*	7.53340E-05*	5.40970E-05*
2,3-Dimethylbutane		0.449000*	0.0481311*	0.0441850*	0.00130716*	1.89218E-05*	1.35876E-05*
2-Methylpentane		3.38255*	0.361868*	0.332200*	0.00781826*	8.00228E-05*	5.74640E-05*
3-Methylpentane		1.89906*	0.202148*	0.185574*	0.0102198*	0.000255460*	0.000183445*
C6		5.72695*	0.628116*	0.576618*	0.00710744*	3.66412E-05*	2.63119E-05*
Methylcyclopentane		0.688911*	0.0646397*	0.0593401*	0.00598975*	0.000246659*	0.000177125*
Benzene		0.0751926*	0.00493738*	0.00453257*	0.00826586*	0.00694927*	0.00499024*
Cyclohexane		0.634733*	0.0564544*	0.0518258*	0.0117697*	0.00111113*	0.000797901*
2-Methylhexane		0.976784*	0.0284996*	0.0261630*	0.00138475*	9.10129E-06*	6.53559E-06*
3-Methylhexane		0.821455*	0.0861030*	0.0790436*	0.00135830*	1.05244E-05*	7.55750E-06*
2,2,4-Trimethylpentane		0*	0*	0*	0*	0*	0*
C7		1.87275*	0.191021*	0.175360*	0.00173651*	6.43542E-06*	4.62124E-06*
Methylcyclohexane		0.672963*	0.0673012*	0.0617834*	0.00607397*	0.000244531*	0.000175597*
Toluene		0.108232*	0.00727182*	0.00667562*	0.0124226*	0.0104722*	0.00752005*
C8		1.04920*	0.105062*	0.0964485*	0.000488231*	7.89235E-07*	5.66746E-07*
Ethylbenzene		0.0413483*	0.00302353*	0.00277564*	0.00473188*	0.00391766*	0.00281325*
m-Xylene		0.0395086*	0.00376107*	0.00345271*	0.00434455*	0.00367378*	0.00263812*
o-Xylene		0.0144127*	0.000872592*	0.000801051*	0.00180942*	0.00150296*	0.00107927*
C9		0.247873*	0.0246917*	0.0226673*	9.53755E-05*	1.44078E-07*	1.03462E-07*
C10		0.0724928*	0.00676613*	0.00621139*	9.48573E-06*	4.29878E-09*	3.08694E-09*
C11		0.0192217*	0.00175479*	0.00161092*	2.29011E-06*	9.69915E-10*	6.96491E-10*
C12		0.00520179*	0.000447535*	0.000410843*	2.09784E-06*	3.16295E-09*	2.27130E-09*
C13		0.00147640*	0.000120509*	0.000110629*	1.52955E-06*	5.61667E-09*	4.03330E-09*
C14		0.000427522*	3.26325E-05*	2.99570E-05*	9.52618E-07*	7.13579E-09*	5.12418E-09*
C15		0.000119870*	9.07728E-06*	8.33306E-06*	5.74695E-07*	8.89205E-09*	6.38534E-09*
C16		3.44007E-05*	2.11468E-06*	1.94130E-06*	4.22753E-07*	1.74114E-08*	1.25030E-08*
C17		1.02392E-05*	5.23676E-07*	4.80741E-07*	3.03473E-07*	3.40020E-08*	2.44167E-08*
C18		3.93721E-06*	1.74915E-07*	1.60574E-07*	2.32079E-07*	6.20075E-08*	4.45273E-08*
C19		1.07818E-06*	3.70006E-08*	3.39671E-08*	1.13809E-07*	7.81915E-08*	5.61490E-08*
C20		2.54198E-07*	1.02423E-08*	9.40255E-09*	4.09806E-08*	2.74531E-08*	1.97139E-08*
C21		6.80048E-08*	2.57196E-09*	2.36110E-09*	1.23528E-08*	8.16225E-09*	5.86127E-09*
C22		2.81520E-08*	7.56304E-10*	6.94296E-10*	5.38385E-09*	3.46518E-09*	2.48833E-09*
C23		7.35045E-09*	1.80300E-10*	1.65518E-10*	1.45464E-09*	9.02298E-10*	6.47936E-10*
C24		1.28602E-09*	4.33100E-11*	3.97592E-11*	2.64227E-10*	1.60851E-10*	1.15506E-10*
C25		4.49870E-10*	1.40344E-11*	1.28837E-11*	9.13478E-11*	5.38947E-11*	3.87015E-11*
C26		1.77386E-10*	7.16381E-12*	6.57647E-12*	3.59916E-11*	2.05734E-11*	1.47736E-11*
C27		1.52620E-11*	7.48930E-13*	6.87527E-13*	3.17994E-12*	1.75774E-12*	1.26223E-12*
C28		1.12537E-11*	1.30726E-13*	1.20008E-13*	2.24592E-12*	1.20624E-12*	8.66193E-13*
C29		4.59667E-12*	5.17573E-14*	4.75138E-14*	9.44282E-13*	5.02869E-13*	3.61108E-13*
C30		1.27900E-11*	3.32489E-14*	3.05229E-14*	2.58544E-12*	1.33021E-12*	9.55217E-13*
H2O		0.0944786*	4.88463E-06*	4.48416E-06*	0.469081*	0.373082*	0.267908*
Oxygen		0*	0*	0*	0*	0*	0*
	lb/hr:	213.84	24.57	22.55	2.34	0.09	0.06
	TPY:	936.63	107.61	98.79	10.25	0.39	0.28

TABLE 1-B

COMPOSITIONAL ANALYSIS OF THE SEPARATOR GAS, OIL AND MATHEMATICALLY RECOMBINED WELLSTREAM THROUGH C₁₁₊

SEPARATOR GOR.....: 4381 Scf/Sep Bbl
 SEPARATOR PRESSURE.....: 215 psig
 SEPARATOR TEMPERATURE.....: 55 °F

Component	SEPARATOR GAS		SEPARATOR OIL		WELLSTREAM	
	Mole%	* GPM	Mole %	Liquid Volume %	Mole %	* GPM
Hydrogen Sulfide	0.000	0.000	0.000	0.000	0.000	0.000
Nitrogen	0.496	0.000	0.015	0.004	0.405	0.000
Carbon Dioxide	0.133	0.000	0.010	0.011	0.110	0.000
Methane	70.754	0.000	5.084	0.773	58.285	0.000
Ethane	18.380	4.955	9.419	6.156	16.678	4.496
Propane	7.198	1.999	13.438	9.048	8.383	2.328
Iso-butane	0.590	0.195	2.701	2.160	0.991	0.327
N-butane	1.711	0.544	11.641	8.969	3.596	1.143
2-2 Dimethylpropane	0.000	0.000	0.173	0.162	0.033	0.013
Iso-pentane	0.211	0.078	3.777	3.376	0.888	0.327
N-pentane	0.317	0.116	7.673	6.798	1.714	0.626
2-2 Dimethylbutane	0.003	0.001	0.087	0.088	0.019	0.008
Cyclopentane	0.003	0.001	0.000	0.000	0.002	0.001
2-3 Dimethylbutane	0.005	0.002	0.246	0.246	0.051	0.021
2 Methylpentane	0.039	0.016	2.037	2.067	0.418	0.175
3 Methylpentane	0.022	0.009	1.250	1.248	0.255	0.105
Other Hexanes	0.000	0.000	0.000	0.000	0.000	0.000
n-Hexane	0.067	0.028	4.799	4.823	0.965	0.400
Methylcyclopentane	0.005	0.002	0.578	0.500	0.114	0.041
Benzene	0.001	0.000	0.067	0.046	0.014	0.004
Cyclohexane	0.006	0.002	0.688	0.573	0.136	0.047
2-Methylhexane	0.007	0.003	1.483	1.685	0.287	0.135
3-Methylhexane	0.007	0.003	1.361	1.527	0.264	0.122
2,2,4 Trimethylpentane	0.000	0.000	0.000	0.000	0.000	0.000
Other Heptanes	0.007	0.003	0.628	0.680	0.125	0.056
n-Heptane	0.014	0.007	3.405	3.839	0.658	0.306
Methylcyclohexane	0.006	0.002	1.433	1.408	0.277	0.112
Toluene	0.001	0.000	0.271	0.222	0.052	0.018
Other C-8's	0.008	0.004	4.169	4.862	0.798	0.384
n-Octane	0.003	0.002	2.165	2.710	0.413	0.214
Ethylbenzene	0.000	0.000	0.283	0.267	0.054	0.021
M&P-Xylene	0.001	0.000	0.288	0.273	0.055	0.022
O-Xylene	0.000	0.000	0.123	0.114	0.023	0.009
Other C-9's	0.002	0.001	2.999	3.907	0.571	0.307
n-Nonane	0.001	0.001	1.367	1.880	0.260	0.148
Other C10's	0.000	0.000	2.719	3.893	0.516	0.305
n-Decane	0.000	0.000	0.845	1.268	0.160	0.099
Undecanes Plus	0.002	0.001	12.778	24.418	2.428	1.913
TOTAL	100.000	7.974	100.000	100.000	100.000	14.229

TABLE 1-B

COMPOSITIONAL ANALYSIS OF THE SEPARATOR GAS, OIL AND MATHEMATICALLY RECOMBINED WELLSTREAM THROUGH C₁₁₊

SEPARATOR GOR.....: 4381 Scf/Sep Bbl
 SEPARATOR PRESSURE.....: 215 psig
 SEPARATOR TEMPERATURE.....: 55 °F

UNDECANES PLUS (C ₁₁₊) FRACTION CHARACTERISTICS						
COMPONENT	Specific Gravity		Molecular Weight lb/lb-mole	Vapor Volume Scf/Gal	Gross Heating Value	
	°API	**			***	
Gas	N/A	0.8250	156.000	16.558	8,400	
Oil	41.949	0.8158	201.300	12.689	130,622	
Wellstream	N/A	0.8158	201.270	12.691	N/A	

TOTAL SAMPLE CHARACTERISTICS						
COMPONENT	Specific Gravity		Molecular Weight lb/lb-mole	Vapor Volume Scf/Gal	Gross Heating Value	
	°API	**			Dry ***	Saturated ***
Gas	N/A	0.7683	22.159	125.402	1,348	1,325
Oil	77.724	0.6763	87.330	24.247	N/A	114,325
Wellstream	N/A	1.1924	34.534	55.616	N/A	N/A

- * GPM (gallons per Mscf) determined at 14.85 psia and 60 °F
- ** Gas specific gravity and wellstream specific gravity determined relative to air (SG=1.000).
Oil specific gravity determined relative to water (SG=1.000).
- *** Gross Heating Value units for gas (real basis) and oil are BTU/Scf and BTU/Gal, respectively.

ATTACHMENT M: NATURAL GAS FIRED FUEL BURNING UNITS DATA SHEET

AP-42 EMISSION FACTORS

**ATTACHMENT M – SMALL HEATERS AND REBOILERS NOT SUBJECT TO
40CFR60 SUBPART DC
DATA SHEET**

Complete this data sheet for each small heater and reboiler not subject to 40CFR60 Subpart Dc at the facility. *The Maximum Design Heat Input (MDHI) must be less than 10 MMBTU/hr.*

Emission Unit ID# ¹	Emission Point ID# ²	Emission Unit Description (manufacturer, model #)	Year Installed/Modified	Type ³ and Date of Change	Maximum Design Heat Input (MMBTU/hr) ⁴	Fuel Heating Value (BTU/scf) ⁵
EU-GPU1	EP-GPU1	Gas Production Unit Burner	2013	EXIST	1.0	905
EU-GPU2	EP-GPU2	Gas Production Unit Burner	TBD	NEW	1.0	905
EU-GPU3	EP-GPU3	Gas Production Unit Burner	TBD	NEW	1.0	905
EU-GPU4	EP-GPU4	Gas Production Unit Burner	TBD	NEW	1.0	905
EU-SH1	EP-SH1	Stabilizer Heater	TBD	NEW	1.5	905
EU-SH2	EP-SH2	Stabilizer Heater	TBD	NEW	1.5	905

- ¹ Enter the appropriate Emission Unit (or Source) identification number for each fuel burning unit located at the production pad. Gas Producing Unit Burners should be designated GPU-1, GPU-2, etc. Heater Treaters should be designated HT-1, HT-2, etc. Heaters or Line Heaters should be designated LH-1, LH-2, etc. For sources, use 1S, 2S, 3S...or other appropriate designation. Enter glycol dehydration unit Reboiler Vent data on the Glycol Dehydration Unit Data Sheet.
- ² Enter the appropriate Emission Point identification numbers for each fuel burning unit located at the production pad. Gas Producing Unit Burners should be designated GPU-1, GPU-2, etc. Heater Treaters should be designated HT-1, HT-2, etc. Heaters or Line Heaters should be designated LH-1, LH-2, etc. For emission points, use 1E, 2E, 3E...or other appropriate designation.
- ³ New, modification, removal
- ⁴ Enter design heat input capacity in MMBtu/hr.
- ⁵ Enter the fuel heating value in BTU/standard cubic foot.

Table 1.4-1. EMISSION FACTORS FOR NITROGEN OXIDES (NO_x) AND CARBON MONOXIDE (CO)
FROM NATURAL GAS COMBUSTION^a

Combustor Type (MMBtu/hr Heat Input) [SCC]	NO _x ^b		CO	
	Emission Factor (lb/10 ⁶ scf)	Emission Factor Rating	Emission Factor (lb/10 ⁶ scf)	Emission Factor Rating
Large Wall-Fired Boilers (>100) [1-01-006-01, 1-02-006-01, 1-03-006-01]				
Uncontrolled (Pre-NSPS) ^c	280	A	84	B
Uncontrolled (Post-NSPS) ^c	190	A	84	B
Controlled - Low NO _x burners	140	A	84	B
Controlled - Flue gas recirculation	100	D	84	B
Small Boilers (<100) [1-01-006-02, 1-02-006-02, 1-03-006-02, 1-03-006-03]				
Uncontrolled	100	B	84	B
Controlled - Low NO _x burners	50	D	84	B
Controlled - Low NO _x burners/Flue gas recirculation	32	C	84	B
Tangential-Fired Boilers (All Sizes) [1-01-006-04]				
Uncontrolled	170	A	24	C
Controlled - Flue gas recirculation	76	D	98	D
Residential Furnaces (<0.3) [No SCC]				
Uncontrolled	94	B	40	B

^a Reference 11. Units are in pounds of pollutant per million standard cubic feet of natural gas fired. To convert from lb/10⁶ scf to kg/10⁶ m³, multiply by 16. Emission factors are based on an average natural gas higher heating value of 1,020 Btu/scf. To convert from lb/10⁶ scf to lb/MMBtu, divide by 1,020. The emission factors in this table may be converted to other natural gas heating values by multiplying the given emission factor by the ratio of the specified heating value to this average heating value. SCC = Source Classification Code. ND = no data. NA = not applicable.

^b Expressed as NO₂. For large and small wall fired boilers with SNCR control, apply a 24 percent reduction to the appropriate NO_x emission factor. For tangential-fired boilers with SNCR control, apply a 13 percent reduction to the appropriate NO_x emission factor.

^c NSPS=New Source Performance Standard as defined in 40 CFR 60 Subparts D and Db. Post-NSPS units are boilers with greater than 250 MMBtu/hr of heat input that commenced construction modification, or reconstruction after August 17, 1971, and units with heat input capacities between 100 and 250 MMBtu/hr that commenced construction modification, or reconstruction after June 19, 1984.

TABLE 1.4-3. EMISSION FACTORS FOR SPECIATED ORGANIC COMPOUNDS FROM NATURAL GAS COMBUSTION^a

CAS No.	Pollutant	Emission Factor (lb/10 ⁶ scf)	Emission Factor Rating
91-57-6	2-Methylnaphthalene ^{b,c}	2.4E-05	D
56-49-5	3-Methylchloranthrene ^{b,c}	<1.8E-06	E
	7,12-Dimethylbenz(a)anthracene ^{b,c}	<1.6E-05	E
83-32-9	Acenaphthene ^{b,c}	<1.8E-06	E
203-96-8	Acenaphthylene ^{b,c}	<1.8E-06	E
120-12-7	Anthracene ^{b,c}	<2.4E-06	E
56-55-3	Benz(a)anthracene ^{b,c}	<1.8E-06	E
71-43-2	Benzene ^b	2.1E-03	B
50-32-8	Benzo(a)pyrene ^{b,c}	<1.2E-06	E
205-99-2	Benzo(b)fluoranthene ^{b,c}	<1.8E-06	E
191-24-2	Benzo(g,h,i)perylene ^{b,c}	<1.2E-06	E
205-82-3	Benzo(k)fluoranthene ^{b,c}	<1.8E-06	E
106-97-8	Butane	2.1E+00	E
218-01-9	Chrysene ^{b,c}	<1.8E-06	E
53-70-3	Dibenzo(a,h)anthracene ^{b,c}	<1.2E-06	E
25321-22-6	Dichlorobenzene ^b	1.2E-03	E
74-84-0	Ethane	3.1E+00	E
206-44-0	Fluoranthene ^{b,c}	3.0E-06	E
86-73-7	Fluorene ^{b,c}	2.8E-06	E
50-00-0	Formaldehyde ^b	7.5E-02	B
110-54-3	Hexane ^b	1.8E+00	E
193-39-5	Indeno(1,2,3-cd)pyrene ^{b,c}	<1.8E-06	E
91-20-3	Naphthalene ^b	6.1E-04	E
109-66-0	Pentane	2.6E+00	E
85-01-8	Phenanathrene ^{b,c}	1.7E-05	D

TABLE 1.4-3. EMISSION FACTORS FOR SPECIATED ORGANIC COMPOUNDS FROM NATURAL GAS COMBUSTION (Continued)

CAS No.	Pollutant	Emission Factor (lb/10 ⁶ scf)	Emission Factor Rating
74-98-6	Propane	1.6E+00	E
129-00-0	Pyrene ^{b, c}	5.0E-06	E
108-88-3	Toluene ^b	3.4E-03	C

^a Reference 11. Units are in pounds of pollutant per million standard cubic feet of natural gas fired. Data are for all natural gas combustion sources. To convert from lb/10⁶ scf to kg/10⁶ m³, multiply by 16. To convert from lb/10⁶ scf to lb/MMBtu, divide by 1,020. Emission Factors preceded with a less-than symbol are based on method detection limits.

^b Hazardous Air Pollutant (HAP) as defined by Section 112(b) of the Clean Air Act.

^c HAP because it is Polycyclic Organic Matter (POM). POM is a HAP as defined by Section 112(b) of the Clean Air Act.

^d The sum of individual organic compounds may exceed the VOC and TOC emission factors due to differences in test methods and the availability of test data for each pollutant.

ATTACHMENT N: INTERNAL COMBUSTION ENGINE DATA SHEETS

ENGINE SPECIFICATION SHEETS
AP-42 AND EPA EMISSION FACTORS

ATTACHMENT N – INTERNAL COMBUSTION ENGINE DATA SHEET

Complete this data sheet for each internal combustion engine at the facility. Include manufacturer performance data sheet(s) or any other supporting document if applicable. Use extra pages if necessary. *Generator(s) and microturbine generator(s) shall also use this form.*

Emission Unit ID# ¹		EU-ENG1		EU-ENG2		EU-ENG3	
Engine Manufacturer/Model		Caterpillar G3306 NA		Caterpillar G3306 NA		Caterpillar G3306 TA	
Manufacturers Rated bhp/rpm		145-hp/1,800-rpm		145-hp/1,800-rpm		203-hp/1,800-rpm	
Source Status ²		NS		NS		NS	
Date Installed/ Modified/Removed/Relocated ³		TBD		TBD		TBD	
Engine Manufactured /Reconstruction Date ⁴		After 1/1/2011		After 1/1/2011		After 1/1/2011	
Check all applicable Federal Rules for the engine (include EPA Certificate of Conformity if applicable) ⁵		<input checked="" type="checkbox"/> 40CFR60 Subpart JJJ <input type="checkbox"/> JJJ Certified? <input type="checkbox"/> 40CFR60 Subpart IIII <input type="checkbox"/> IIII Certified? <input checked="" type="checkbox"/> 40CFR63 Subpart ZZZZ <input type="checkbox"/> NESHAP ZZZZ/ NSPS JJJJ Window <input type="checkbox"/> NESHAP ZZZZ Remote Sources		<input checked="" type="checkbox"/> 40CFR60 Subpart JJJ <input type="checkbox"/> JJJ Certified? <input type="checkbox"/> 40CFR60 Subpart IIII <input type="checkbox"/> IIII Certified? <input checked="" type="checkbox"/> 40CFR63 Subpart ZZZZ <input type="checkbox"/> NESHAP ZZZZ/ NSPS JJJJ Window <input type="checkbox"/> NESHAP ZZZZ Remote Sources		<input checked="" type="checkbox"/> 40CFR60 Subpart JJJ <input type="checkbox"/> JJJ Certified? <input type="checkbox"/> 40CFR60 Subpart IIII <input type="checkbox"/> IIII Certified? <input checked="" type="checkbox"/> 40CFR63 Subpart ZZZZ <input type="checkbox"/> NESHAP ZZZZ/ NSPS JJJJ Window <input type="checkbox"/> NESHAP ZZZZ Remote Sources	
Engine Type ⁶		4SRB		4SRB		4SRB	
APCD Type ⁷		NSCR		NSCR		NSCR	
Fuel Type ⁸		PQ		PQ		PQ	
H ₂ S (gr/100 scf)		Negligible		Negligible		Negligible	
Operating bhp/rpm		145-hp/1,800-rpm		145-hp/1,800-rpm		203-hp/1,800-rpm	
BSFC (BTU/bhp-hr)		8,625		8,625		9,015	
Hourly Fuel Throughput		1,382	ft ³ /hr gal/hr	1,382	ft ³ /hr gal/hr	2,022	ft ³ /hr gal/hr
Annual Fuel Throughput (Must use 8,760 hrs/yr unless emergency generator)		12.11	MMft ³ /yr gal/yr	12.11	MMft ³ /yr gal/yr	17.71	MMft ³ /yr gal/yr
Fuel Usage or Hours of Operation Metered		Yes <input type="checkbox"/> No <input checked="" type="checkbox"/>		Yes <input type="checkbox"/> No <input checked="" type="checkbox"/>		Yes <input type="checkbox"/> No <input checked="" type="checkbox"/>	
Calculation Methodology ⁹	Pollutant ¹⁰	Hourly PTE (lb/hr) ¹¹	Annual PTE (tons/year) ¹¹	Hourly PTE (lb/hr) ¹¹	Annual PTE (tons/year) ¹¹	Hourly PTE (lb/hr) ¹¹	Annual PTE (tons/year) ¹¹
MD	NO _x	0.32	1.40	0.32	1.40	0.45	1.96
MD	CO	0.64	2.80	0.64	2.80	0.90	3.92
MD	VOC	0.16	0.69	0.16	0.69	0.23	1.00
AP	SO ₂	<0.01	<0.01	<0.01	<0.01	<0.01	<0.01
AP	PM ₁₀	0.01	0.05	0.01	0.05	0.02	0.08
MD	Formaldehyde	0.09	0.38	0.09	0.38	0.12	0.53
AP	Total HAPs	0.10	0.44	0.10	0.44	0.14	0.62
MD and EPA	GHG (CO ₂ e)	155.19	679.73	155.19	679.73	217.27	951.66

1 Enter the appropriate Source Identification Number for each natural gas-fueled reciprocating internal combustion engine/generator engine located at the well site. Multiple engines should be designated CE-1, CE-2, CE-3 etc. Generator engines should be designated GE-1, GE-2, GE-3 etc. Microturbine generator engines should be designated MT-1, MT-2, MT-3 etc. If more than three (3) engines exist, please use additional sheets.

2 Enter the Source Status using the following codes:

NS Construction of New Source (installation)
 MS Modification of Existing Source
 REM Removal of Source

ES Existing Source
 RS Relocated Source

- 3 Enter the date (or anticipated date) of the engine's installation (construction of source), modification, relocation or removal.
- 4 Enter the date that the engine was manufactured, modified or reconstructed.
- 5 Is the engine a certified stationary spark ignition internal combustion engine according to 40CFR60 Subpart IIII/JJJJ? If so, the engine and control device must be operated and maintained in accordance with the manufacturer's emission-related written instructions. You must keep records of conducted maintenance to demonstrate compliance, but no performance testing is required. If the certified engine is not operated and maintained in accordance with the manufacturer's emission-related written instructions, the engine will be considered a non-certified engine and you must demonstrate compliance as appropriate.

Provide a manufacturer's data sheet for all engines being registered.

- 6 Enter the Engine Type designation(s) using the following codes:

2SLB Two Stroke Lean Burn	4SRB Four Stroke Rich Burn	
4SLB Four Stroke Lean Burn		
- 7 Enter the Air Pollution Control Device (APCD) type designation(s) using the following codes:

A/F Air/Fuel Ratio	IR Ignition Retard	
HEIS High Energy Ignition System	SIPC Screw-in Precombustion Chambers	
PSC Prestratified Charge	LEC Low Emission Combustion	
NSCR Rich Burn & Non-Selective Catalytic Reduction	OxCat Oxidation Catalyst	
SCR Lean Burn & Selective Catalytic Reduction		
- 8 Enter the Fuel Type using the following codes:

PQ Pipeline Quality Natural Gas	RG Raw Natural Gas /Production Gas	D Diesel
---------------------------------	------------------------------------	----------
- 9 Enter the Potential Emissions Data Reference designation using the following codes. Attach all reference data used.

MD Manufacturer's Data	AP AP-42	
GR GRI-HAPCalc TM	OT Other	(please list)
- 10 Enter each engine's Potential to Emit (PTE) for the listed regulated pollutants in pounds per hour and tons per year. PTE shall be calculated at manufacturer's rated brake horsepower and may reflect reduction efficiencies of listed Air Pollution Control Devices. Emergency generator engines may use 500 hours of operation when calculating PTE. PTE data from this data sheet shall be incorporated in the *Emissions Summary Sheet*.
- 11 PTE for engines shall be calculated from manufacturer's data unless unavailable.

**Engine Air Pollution Control Device
(Emission Unit ID# APC-NSCR-ENG1 and ENG2 use extra pages as necessary)**

Air Pollution Control Device Manufacturer's Data Sheet included?
Yes No

NSCR SCR Oxidation Catalyst

Provide details of process control used for proper mixing/control of reducing agent with gas stream:

Manufacturer: N/A

Model #: N/A

Design Operating Temperature: 1,101 °F

Design gas volume: 678 scfm

Service life of catalyst:

Provide manufacturer data? Yes No

Volume of gas handled: acfm at °F

Operating temperature range for NSCR/Ox Cat:
From 600 °F to 1,250 °F

Reducing agent used, if any:

Ammonia slip (ppm):

Pressure drop against catalyst bed (delta P): inches of H₂O

Provide description of warning/alarm system that protects unit when operation is not meeting design conditions:

Is temperature and pressure drop of catalyst required to be monitored per 40CFR63 Subpart ZZZZ?

Yes No

How often is catalyst recommended or required to be replaced (hours of operation)?

How often is performance test required?

Initial

Annual

Every 8,760 hours of operation

Field Testing Required

No performance test required. If so, why (please list any maintenance required and the applicable sections in NSPS/GACT,

**Engine Air Pollution Control Device
(Emission Unit ID# APC-NSCR-ENG3 use extra pages as necessary)**

Air Pollution Control Device Manufacturer's Data Sheet included?
Yes No

NSCR SCR Oxidation Catalyst

Provide details of process control used for proper mixing/control of reducing agent with gas stream:

Manufacturer: N/A	Model #: N/A
Design Operating Temperature: 1,096 °F	Design gas volume: 1,002 scfm
Service life of catalyst:	Provide manufacturer data? <input checked="" type="checkbox"/> Yes <input type="checkbox"/> No
Volume of gas handled: acfm at °F	Operating temperature range for NSCR/Ox Cat: From 600 °F to 1,250 °F
Reducing agent used, if any:	Ammonia slip (ppm):

Pressure drop against catalyst bed (delta P): inches of H₂O

Provide description of warning/alarm system that protects unit when operation is not meeting design conditions:

Is temperature and pressure drop of catalyst required to be monitored per 40CFR63 Subpart ZZZZ?
 Yes No

How often is catalyst recommended or required to be replaced (hours of operation)?

How often is performance test required?
 Initial
 Annual
 Every 8,760 hours of operation
 Field Testing Required
 No performance test required. If so, why (please list any maintenance required and the applicable sections in NSPS/GACT,

G3306 NA

GAS COMPRESSION APPLICATION

GAS ENGINE SITE SPECIFIC TECHNICAL DATA



ENGINE SPEED (rpm):	1800	FUEL SYSTEM:	LPG IMPCO
COMPRESSION RATIO:	10.5:1	WITH CUSTOMER SUPPLIED AIR FUEL RATIO CONTROL	
JACKET WATER OUTLET (°F):	210	SITE CONDITIONS:	
COOLING SYSTEM:	JW+OC	FUEL:	Nat Gas
IGNITION SYSTEM:	MAG	FUEL PRESSURE RANGE (psig):	1.5-10.0
EXHAUST MANIFOLD:	WC	FUEL METHANE NUMBER:	84.8
COMBUSTION:	Catalyst	FUEL LHV (Btu/scf):	905
EXHAUST O2 EMISSION LEVEL %:	0.5	ALTITUDE (ft):	500
SET POINT TIMING:	30.0	MAXIMUM INLET AIR TEMPERATURE (°F):	77
		NAMEPLATE RATING:	145 bhp@1800rpm

RATING	NOTES	LOAD	MAXIMUM RATING	SITE RATING AT MAXIMUM INLET AIR TEMPERATURE		
			100%	100%	75%	50%
ENGINE POWER	(1)	bhp	145	145	109	72
INLET AIR TEMPERATURE		°F	77	77	77	77

ENGINE DATA						
FUEL CONSUMPTION (LHV)	(2)	Btu/bhp-hr	7775	7775	8318	9509
FUEL CONSUMPTION (HHV)	(2)	Btu/bhp-hr	8625	8625	9227	10548
AIR FLOW	(3)(4)	lb/hr	922	922	739	556
AIR FLOW WET (77°F, 14.7 psia)	(3)(4)	scfm	208	208	167	125
INLET MANIFOLD PRESSURE	(5)	in Hg(abs)	26.2	26.2	21.8	17.6
EXHAUST STACK TEMPERATURE	(6)	°F	1101	1101	1067	1037
EXHAUST GAS FLOW (@ stack temp, 14.5 psia)	(7)(4)	ft3/min	678	678	532	393
EXHAUST GAS MASS FLOW	(7)(4)	lb/hr	978	978	784	590

EMISSIONS DATA						
NOx (as NO2)	(8)	g/bhp-hr	13.47	13.47	12.15	9.76
CO	(8)	g/bhp-hr	13.47	13.47	11.44	9.56
THC (mol. wt. of 15.84)	(8)	g/bhp-hr	2.20	2.20	2.49	3.22
NMHC (mol. wt. of 15.84)	(8)	g/bhp-hr	0.33	0.33	0.37	0.48
NMNEHC (VOCs) (mol. wt. of 15.84)	(8)(9)	g/bhp-hr	0.22	0.22	0.25	0.32
HCHO (Formaldehyde)	(8)	g/bhp-hr	0.27	0.27	0.31	0.33
CO2	(8)	g/bhp-hr	485	485	525	601
EXHAUST OXYGEN	(10)	% DRY	0.5	0.5	0.5	0.5

HEAT REJECTION						
HEAT REJ. TO JACKET WATER (JW)	(11)	Btu/min	6049	6049	5237	4455
HEAT REJ. TO ATMOSPHERE	(11)	Btu/min	751	751	602	459
HEAT REJ. TO LUBE OIL (OC)	(11)	Btu/min	990	990	857	729

HEAT EXCHANGER SIZING CRITERIA			
TOTAL JACKET WATER CIRCUIT (JW+OC)	(12)	Btu/min	7842

CONDITIONS AND DEFINITIONS

Engine rating obtained and presented in accordance with ISO 3046/1, adjusted for fuel, site altitude and site inlet air temperature.
 100% rating at maximum inlet air temperature is the maximum engine capability for the specified fuel at site altitude and maximum site inlet air temperature.
 Max. rating is the maximum capability for the specified fuel at site altitude and reduced inlet air temperature.
 Lowest load point is the lowest continuous duty operating load allowed. No overload permitted at rating shown.

For notes information consult page three.



Prepared For:

Jason Stinson
MIDCON COMPRESSION, LP

MANUFACTURED ON OR AFTER 1/1/2011

INFORMATION PROVIDED BY CATERPILLAR

Engine:	G3306 NA
Horsepower:	145
RPM:	1800
Compression Ratio:	10.5:1
Exhaust Flow Rate:	678 CFM
Exhaust Temperature:	1101 °F
Reference:	DM5053-07
Fuel:	Natural Gas
Annual Operating Hours:	8760

Uncontrolled Emissions

NOx:	13.47 g/bhp-hr
CO:	13.47 g/bhp-hr
THC:	2.20 g/bhp-hr
NMHC:	0.33 g/bhp-hr
NMNEHC:	0.22 g/bhp-hr
HCHO:	0.27 g/bhp-hr
Oxygen:	0.50 %

POST CATALYST EMISSIONS

NOx:	<1.0 g/bhp-hr
CO:	<2.0 g/bhp-hr
VOC:	<0.7 g/bhp-hr

CONTROL EQUIPMENT

Catalytic Converter

Model:	EAH-1200T-0404F-21CEE
Catalyst Type:	NSCR, Precious group metals
Manufacturer:	EMIT Technologies, Inc.
Element Size:	Round 12 x 3.5
Catalyst Elements:	1
Housing Type:	2 Element Capacity
Catalyst Installation:	Accessible Housing
Construction:	10 gauge Carbon Steel
Sample Ports:	6 (0.5" NPT)
Inlet Connections:	4" Flat Face Flange
Outlet Connections:	4" Flat Face Flange
Configuration:	End In / End Out
Silencer:	Integrated
Silencer Grade:	Hospital
Insertion Loss:	35-40 dBA

Air Fuel Ratio Controller

Model:	ENG-S-075-T
Manufacturer:	EMIT Technologies, Inc.
Description:	EDGE NG Air Fuel Ratio Controller 4-Wire Narrowband O2 Sensor Digital Power Valve O2 Sensor Weldment Wiring Harness (2) 25' Type K Thermocouple
Digital Power Valve Size:	0.75" NPT

GAS COMPRESSION APPLICATION

ENGINE SPEED (rpm): 1800
 COMPRESSION RATIO: 8
 AFTERCOOLER TYPE: SCAC
 AFTERCOOLER WATER INLET (°F): 130
 JACKET WATER OUTLET (°F): 210
 ASPIRATION: TA
 COOLING SYSTEM: JW+OC, AC
 CONTROL SYSTEM: MAG
 EXHAUST MANIFOLD: WC
 COMBUSTION: CATALYST SETTING
 EXHAUST OXYGEN (% O2): 0.5
 SET POINT TIMING: 27

RATING STRATEGY: STANDARD
 RATING LEVEL: CONTINUOUS
 FUEL SYSTEM: HPG IMPCO
 WITH CUSTOMER SUPPLIED AIR FUEL RATIO CONTROL

SITE CONDITIONS:

FUEL: Gas Analysis
 FUEL PRESSURE RANGE (psig): (See note 1) 12.0-24.9
 FUEL METHANE NUMBER: 52.8
 FUEL LHV (Btu/scf): 1235
 ALTITUDE(ft): 500
 MAXIMUM INLET AIR TEMPERATURE(°F): 77
 STANDARD RATED POWER: 203 bhp@1800rpm

RATING	NOTES	LOAD	MAXIMUM RATING	SITE RATING AT MAXIMUM INLET AIR TEMPERATURE		
			100%	100%	75%	50%
ENGINE POWER (WITHOUT FAN)	(2)	bhp	203	203	152	101
INLET AIR TEMPERATURE		°F	77	77	77	77

ENGINE DATA							
FUEL CONSUMPTION (LHV)	(3)	Btu/bhp-hr	8192	8192	8540	9301	
FUEL CONSUMPTION (HHV)	(3)	Btu/bhp-hr	9015	9015	9398	10236	
AIR FLOW (@inlet air temp, 14.7 psia)	(4)(5)	ft3/min	312	312	249	182	
AIR FLOW (WET)	(4)(5)	lb/hr	1384	1384	1106	807	
FUEL FLOW (60°F, 14.7 psia)	(4)(5)	scfm	22	22	18	13	
INLET MANIFOLD PRESSURE	(6)	in Hg(abs)	37.8	37.8	31.7	24.5	
EXHAUST TEMPERATURE - ENGINE OUTLET	(7)	°F	1096	1096	1061	1018	
EXHAUST GAS FLOW (@engine outlet temp, 14.5 psia)	(8)(5)	ft3/min	1002	1002	781	554	
EXHAUST GAS MASS FLOW (WET)	(8)(5)	lb/hr	1464	1464	1168	853	

EMISSIONS DATA - ENGINE OUT							
NOx (as NO2)	(9)(10)	g/bhp-hr	15.79	15.79	15.50	13.13	
CO	(9)(10)	g/bhp-hr	15.79	15.79	15.50	13.13	
THC (mol. wt. of 15.84)	(9)(10)	g/bhp-hr	1.00	1.00	1.16	1.40	
NMHC (mol. wt. of 15.84)	(9)(10)	g/bhp-hr	0.53	0.53	0.61	0.73	
NMNEHC (VOCs) (mol. wt. of 15.84)	(9)(10)(11)	g/bhp-hr	0.26	0.26	0.31	0.37	
HCHO (Formaldehyde)	(9)(10)	g/bhp-hr	0.25	0.25	0.25	0.25	
CO2	(9)(10)	g/bhp-hr	569	569	611	677	
EXHAUST OXYGEN	(9)(12)	% DRY	0.4	0.4	0.4	0.4	

HEAT REJECTION							
HEAT REJ. TO JACKET WATER (JW)	(13)	Btu/min	9012	9012	7527	6036	
HEAT REJ. TO ATMOSPHERE	(13)	Btu/min	1108	1108	866	629	
HEAT REJ. TO LUBE OIL (OC)	(13)	Btu/min	1425	1425	1190	954	
HEAT REJ. TO AFTERCOOLER (AC)	(13)(14)	Btu/min	532	532	214	31	

COOLING SYSTEM SIZING CRITERIA			
TOTAL JACKET WATER CIRCUIT (JW+OC)	(14)	Btu/min	11624
TOTAL AFTERCOOLER CIRCUIT (AC)	(14)(15)	Btu/min	558
A cooling system safety factor of 0% has been added to the cooling system sizing criteria.			

CONDITIONS AND DEFINITIONS

Engine rating obtained and presented in accordance with ISO 3046/1, adjusted for fuel, site altitude and site inlet air temperature. 100% rating at maximum inlet air temperature is the maximum engine capability for the specified fuel at site altitude and maximum site inlet air temperature. Maximum rating is the maximum capability at the specified aftercooler inlet temperature for the specified fuel at site altitude and reduced inlet air temperature. Lowest load point is the lowest continuous duty operating load allowed. No overload permitted at rating shown.

For notes information consult page three.

*****WARNINGS ISSUED FOR THIS RATING CONSULT PAGE 3*****

Engine Power vs. Inlet Air Temperature

Data represents temperature sweep at 500 ft and 1800 rpm

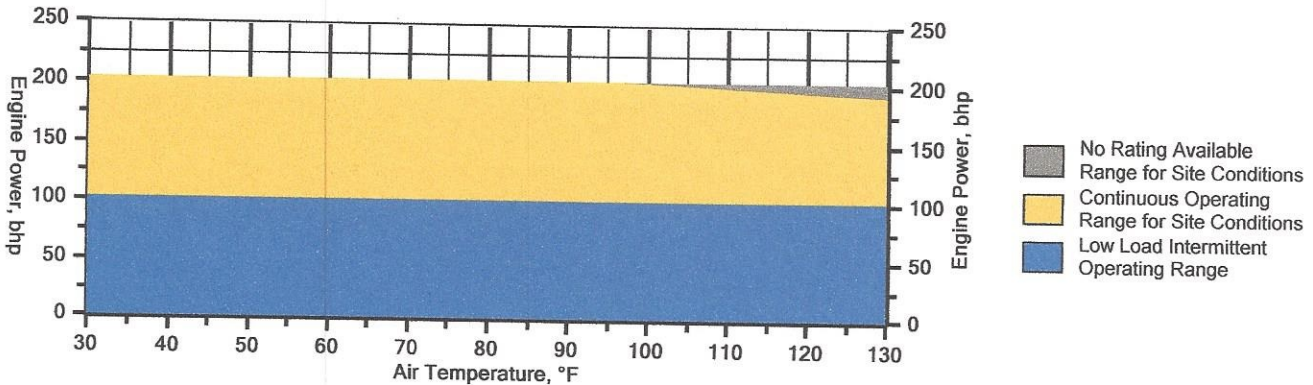

Engine Power vs. Engine Speed

Data represents speed sweep at 500 ft and 77 °F

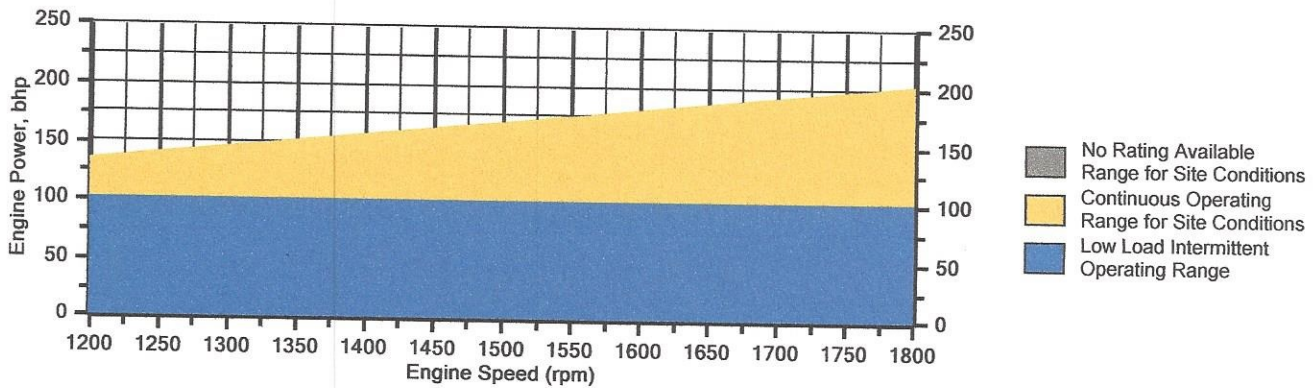

Engine Torque vs. Engine Speed

Data represents speed sweep at 500 ft and 77 °F

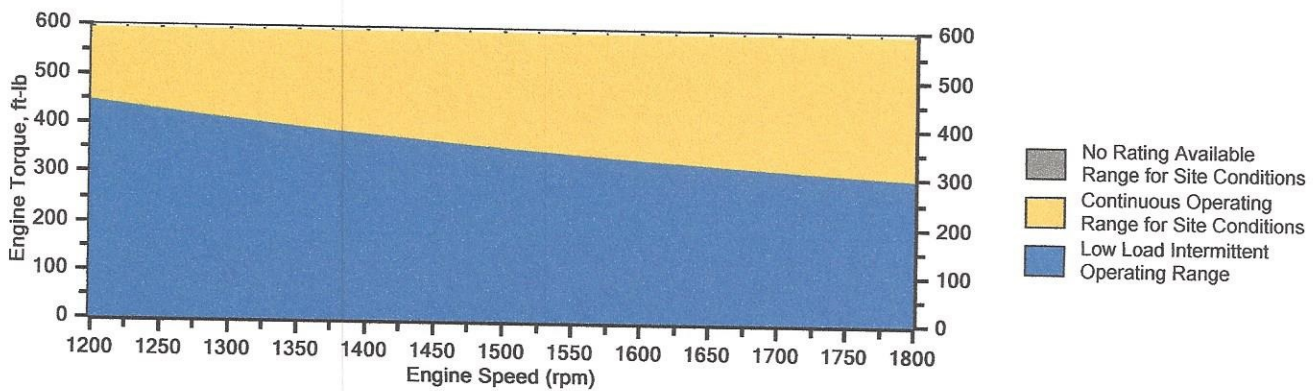

Note: At site conditions of 500 ft and 77°F inlet air temp., constant torque can be maintained down to 1200 rpm. The minimum speed for loading at these conditions is 1200 rpm.

GAS COMPRESSION APPLICATION

NOTES

1. Fuel pressure range specified is to the engine fuel pressure regulator. Additional fuel train components should be considered in pressure and flow calculations.
2. Engine rating is with two engine driven water pumps. Tolerance is $\pm 3\%$ of full load.
3. Fuel consumption tolerance is $\pm 5.0\%$ of full load data.
4. Air flow value is on a 'wet' basis. Flow is a nominal value with a tolerance of $\pm 5\%$.
5. Inlet and Exhaust Restrictions must not exceed A&I limits based on full load flow rates from the standard technical data sheet.
6. Inlet manifold pressure is a nominal value with a tolerance of $\pm 5\%$.
7. Exhaust temperature is a nominal value with a tolerance of $(+)63^{\circ}\text{F}$, $(-)54^{\circ}\text{F}$.
8. Exhaust flow value is on a "wet" basis. Flow is a nominal value with a tolerance of $\pm 6\%$.
9. Emissions data is at engine exhaust flange prior to any after treatment.
10. Emission values are based on engine operating at steady state conditions. Fuel methane number cannot vary more than ± 3 . Values listed are higher than nominal levels to allow for instrumentation, measurement, and engine-to-engine variations. They indicate "Not to Exceed" values. THC, NMHC, and NMNEHC do not include aldehydes. Part Load data requires customer supplied air fuel ratio control.
11. VOCs - Volatile organic compounds as defined in US EPA 40 CFR 60, subpart JJJJ
12. Exhaust Oxygen tolerance is ± 0.2 .
13. Heat rejection values are nominal. Tolerances, based on treated water, are $\pm 10\%$ for jacket water circuit, $\pm 50\%$ for radiation, $\pm 20\%$ for lube oil circuit, and $\pm 5\%$ for aftercooler circuit.
14. Aftercooler heat rejection includes an aftercooler heat rejection factor for the site elevation and inlet air temperature specified. Aftercooler heat rejection values at part load are for reference only. Do not use part load data for heat exchanger sizing.
15. Cooling system sizing criteria are maximum circuit heat rejection for the site, with applied tolerances.

WARNING(S):

1. The lower heating value of the fuel is higher than or equal to 1050 Btu/scf and lower than 1400 Btu/scf. May require on-site adjustment or tuning of the fuel system hardware.

RECOMMENDED ACTION

For additional information please contact your Caterpillar engine dealer.

Constituent	Abbrev	Mole %	Norm
Water Vapor	H2O	0.0000	0.0000
Methane	CH4	69.4050	69.4050
Ethane	C2H6	18.9290	18.9290
Propane	C3H8	7.4500	7.4500
Isobutane	iso-C4H10	0.6140	0.6140
Norbutane	nor-C4H10	1.8670	1.8670
Isopentane	iso-C5H12	0.2950	0.2950
Norpentane	nor-C5H12	0.4460	0.4460
Hexane	C6H14	0.4130	0.4130
Heptane	C7H16	0.0000	0.0000
Nitrogen	N2	0.5680	0.5680
Carbon Dioxide	CO2	0.0130	0.0130
Hydrogen Sulfide	H2S	0.0000	0.0000
Carbon Monoxide	CO	0.0000	0.0000
Hydrogen	H2	0.0000	0.0000
Oxygen	O2	0.0000	0.0000
Helium	HE	0.0000	0.0000
Neopentane	neo-C5H12	0.0000	0.0000
Octane	C8H18	0.0000	0.0000
Nonane	C9H20	0.0000	0.0000
Ethylene	C2H4	0.0000	0.0000
Propylene	C3H6	0.0000	0.0000
TOTAL (Volume %)		100.0000	100.0000

Fuel Makeup: Gas Analysis
Unit of Measure: English

Calculated Fuel Properties

Caterpillar Methane Number: 52.8
Lower Heating Value (Btu/scf): 1235
Higher Heating Value (Btu/scf): 1359
WOBBE Index (Btu/scf): 1398
THC: Free Inert Ratio: 171.12
Total % Inerts (% N2, CO2, He): 0.58%
RPC (%) (To 905 Btu/scf Fuel): 100%
Compressibility Factor: 0.996
Stoich A/F Ratio (Vol/Vol): 12.78
Stoich A/F Ratio (Mass/Mass): 16.37
Specific Gravity (Relative to Air): 0.781
Fuel Specific Heat Ratio (K): 1.268

CONDITIONS AND DEFINITIONS

Caterpillar Methane Number represents the knock resistance of a gaseous fuel. It should be used with the Caterpillar Fuel Usage Guide for the engine and rating to determine the rating for the fuel specified. A Fuel Usage Guide for each rating is included on page 2 of its standard technical data sheet.

RPC always applies to naturally aspirated (NA) engines, and turbocharged (TA or LE) engines only when they are derated for altitude and ambient site conditions.

Project specific technical data sheets generated by the Caterpillar Gas Engine Rating Pro program take the Caterpillar Methane Number and RPC into account when generating a site rating.

Fuel properties for Btu/scf calculations are at 60F and 14.696 psia.

Caterpillar shall have no liability in law or equity, for damages, consequently or otherwise, arising from use of program and related material or any part thereof.

FUEL LIQUIDS

Field gases, well head gases, and associated gases typically contain liquid water and heavy hydrocarbons entrained in the gas. To prevent detonation and severe damage to the engine, hydrocarbon liquids must not be allowed to enter the engine fuel system. To remove liquids, a liquid separator and coalescing filter are recommended, with an automatic drain and collection tank to prevent contamination of the ground in accordance with local codes and standards.

To avoid water condensation in the engine or fuel lines, limit the relative humidity of water in the fuel to 80% at the minimum fuel operating temperature.

WARNING(S)

1. The lower heating value of the fuel is higher than or equal to 1050 Btu/scf and lower than 1400 Btu/scf. May require on-site adjustment or tuning of the fuel system hardware.

RECOMMENDED ACTION

For additional information please contact your Caterpillar engine dealer.

Table 3.2-3. UNCONTROLLED EMISSION FACTORS FOR 4-STROKE RICH-BURN
 ENGINES^a
 (SCC 2-02-002-53)

Pollutant	Emission Factor (lb/MMBtu) ^b (fuel input)	Emission Factor Rating
Criteria Pollutants and Greenhouse Gases		
NO _x ^c 90 - 105% Load	2.21 E+00	A
NO _x ^c <90% Load	2.27 E+00	C
CO ^c 90 - 105% Load	3.72 E+00	A
CO ^c <90% Load	3.51 E+00	C
CO ₂ ^d	1.10 E+02	A
SO ₂ ^e	5.88 E-04	A
TOC ^f	3.58 E-01	C
Methane ^g	2.30 E-01	C
VOC ^h	2.96 E-02	C
PM10 (filterable) ^{i,j}	9.50 E-03	E
PM2.5 (filterable) ^j	9.50 E-03	E
PM Condensable ^k	9.91 E-03	E
Trace Organic Compounds		
1,1,2,2-Tetrachloroethane ^l	2.53 E-05	C
1,1,2-Trichloroethane ^l	<1.53 E-05	E
1,1-Dichloroethane	<1.13 E-05	E
1,2-Dichloroethane	<1.13 E-05	E
1,2-Dichloropropane	<1.30 E-05	E
1,3-Butadiene ^l	6.63 E-04	D
1,3-Dichloropropene ^l	<1.27 E-05	E
Acetaldehyde ^{l,m}	2.79 E-03	C
Acrolein ^{l,m}	2.63 E-03	C
Benzene ^l	1.58 E-03	B
Butyr/isobutyraldehyde	4.86 E-05	D
Carbon Tetrachloride ^l	<1.77 E-05	E

Table 3.2-3. UNCONTROLLED EMISSION FACTORS FOR 4-STROKE RICH-BURN ENGINES
(Concluded)

Pollutant	Emission Factor (lb/MMBtu) ^b (fuel input)	Emission Factor Rating
Chlorobenzene ¹	<1.29 E-05	E
Chloroform ¹	<1.37 E-05	E
Ethane ⁿ	7.04 E-02	C
Ethylbenzene ¹	<2.48 E-05	E
Ethylene Dibromide ¹	<2.13 E-05	E
Formaldehyde ^{1,m}	2.05 E-02	A
Methanol ¹	3.06 E-03	D
Methylene Chloride ¹	4.12 E-05	C
Naphthalene ¹	<9.71 E-05	E
PAH ¹	1.41 E-04	D
Styrene ¹	<1.19 E-05	E
Toluene ¹	5.58 E-04	A
Vinyl Chloride ¹	<7.18 E-06	E
Xylene ¹	1.95 E-04	A

^a Reference 7. Factors represent uncontrolled levels. For NO_x, CO, and PM-10, “uncontrolled” means no combustion or add-on controls; however, the factor may include turbocharged units. For all other pollutants, “uncontrolled” means no oxidation control; the data set may include units with control techniques used for NO_x control, such as PCC and SCR for lean burn engines, and PSC for rich burn engines. Factors are based on large population of engines. Factors are for engines at all loads, except as indicated. SCC = Source Classification Code. TOC = Total Organic Compounds. PM10 = Particulate Matter ≤ 10 microns (μm) aerodynamic diameter. A “<” sign in front of a factor means that the corresponding emission factor is based on one-half of the method detection limit.

^b Emission factors were calculated in units of (lb/MMBtu) based on procedures in EPA Method 19. To convert from (lb/MMBtu) to (lb/10⁶ scf), multiply by the heat content of the fuel. If the heat content is not available, use 1020 Btu/scf. To convert from (lb/MMBtu) to (lb/hp-hr) use the following equation:

$$\text{lb/hp-hr} = (\text{lb/MMBtu}) (\text{heat input, MMBtu/hr}) (1/\text{operating HP, 1/hp})$$

^c Emission tests with unreported load conditions were not included in the data set.

^d Based on 99.5% conversion of the fuel carbon to CO₂. CO₂ [lb/MMBtu] = (3.67)(%CON)(C)(D)(1/h), where %CON = percent conversion of fuel carbon to CO₂,

C = carbon content of fuel by weight (0.75), D = density of fuel, 4.1 E+04 lb/10⁶ scf, and h = heating value of natural gas (assume 1020 Btu/scf at 60°F).

^e Based on 100% conversion of fuel sulfur to SO₂. Assumes sulfur content in natural gas of 2,000 gr/10⁶ scf.

^f Emission factor for TOC is based on measured emission levels from 6 source tests.

^g Emission factor for methane is determined by subtracting the VOC and ethane emission factors from the TOC emission factor.

^h VOC emission factor is based on the sum of the emission factors for all speciated organic compounds. Methane and ethane emissions were not measured for this engine category.

ⁱ No data were available for uncontrolled engines. PM10 emissions are for engines equipped with a PCC.

^j Considered $\leq 1 \mu\text{m}$ in aerodynamic diameter. Therefore, for filterable PM emissions, PM10(filterable) = PM2.5(filterable).

^k No data were available for condensable emissions. The presented emission factor reflects emissions from 4SLB engines.

^l Hazardous Air Pollutant as defined by Section 112(b) of the Clean Air Act.

^m For rich-burn engines, no interference is suspected in quantifying aldehyde emissions. The presented emission factors are based on FTIR and CARB 430 emissions data measurements.

ⁿ Ethane emission factor is determined by subtracting the VOC emission factor from the NMHC emission factor.

ATTACHMENT O: TANKER TRUCK LOADING DATA SHEET

AP-42 EMISSION FACTORS

ATTACHMENT O – TANKER TRUCK/RAIL CAR LOADING DATA SHEET

Complete this data sheet for each new or modified bulk liquid transfer area or loading rack at the facility. This is to be used for bulk liquid transfer operations to tanker trucks/rail cars. Use extra pages if necessary.

Truck/Rail Car Loadout Collection Efficiencies

The following applicable capture efficiencies of a truck/rail car loadout are allowed:

- For tanker trucks/rail cars passing the MACT level annual leak test – 99.2%
- For tanker trucks/rail cars passing the NSPS level annual leak test – 98.7%
- For tanker trucks/rail cars not passing one of the annual leak tests listed above – 70%

Compliance with this requirement shall be demonstrated by keeping records of the applicable MACT or NSPS Annual Leak Test certification for *every* truck and railcar loaded/unloaded. This requirement can be satisfied if the trucking/rail car company provided certification that its entire fleet was compliant. This certification must be submitted in writing to the Director of the DAQ. These additional requirements must be noted in the Registration Application.

Emission Unit ID#: EU-LOAD-COND	Emission Point ID#: EP-LOAD-COND/APC-COMB	Year Installed/Modified: 2013/2017		
Emission Unit Description: Condensate Truck Loading Emissions				
Loading Area Data				
Number of Pumps: 1	Number of Liquids Loaded: 1	Max number of trucks/rail cars loading at one (1) time: 1		
Are tanker trucks/rail cars pressure tested for leaks at this or any other location? <input type="checkbox"/> Yes <input checked="" type="checkbox"/> No <input type="checkbox"/> Not Required If Yes, Please describe:				
Provide description of closed vent system and any bypasses. Vapors are collected and routed to a vapor combustor.				
Are any of the following truck/rail car loadout systems utilized? <input type="checkbox"/> Closed System to tanker truck/rail car passing a MACT level annual leak test? <input type="checkbox"/> Closed System to tanker truck/rail car passing a NSPS level annual leak test? <input type="checkbox"/> Closed System to tanker truck/rail car not passing an annual leak test and has vapor return?				
Projected Maximum Operating Schedule (for rack or transfer point as a whole)				
Time	Jan – Mar	Apr - Jun	Jul – Sept	Oct - Dec
Hours/day	24	24	24	24
Days/week	5	5	5	5
Bulk Liquid Data (use extra pages as necessary)				
Liquid Name	Condensate			
Max. Daily Throughput (1000 gal/day)	74.81			
Max. Annual Throughput (1000 gal/yr)	27,307.33			
Loading Method ¹	SUB			
Max. Fill Rate (gal/min)	125			
Average Fill Time (min/loading)	Approx. 60			
Max. Bulk Liquid Temperature (°F)	79.71			
True Vapor Pressure ²	13.5396			
Cargo Vessel Condition ³	U			
Control Equipment or Method ⁴	O = Vapor Return/ Combustion Controls			

Max. Collection Efficiency (%)		70%		
Max. Control Efficiency (%)		98%		
Max.VOC Emission Rate	Loading (lb/hr)	17.14		
	Annual (ton/yr)	32.28		
Max.HAP Emission Rate	Loading (lb/hr)	1.11		
	Annual (ton/yr)	2.09		
Estimation Method ⁵		EPA/O = ProMax process simulation		

Emission Unit ID#: EU-LOAD-PW		Emission Point ID#: EP-LOAD-PW		Year Installed/Modified: 2013/2017	
Emission Unit Description: Produced Water Truck Loading Emissions					
Loading Area Data					
Number of Pumps: 1		Number of Liquids Loaded: 1		Max number of trucks/rail cars loading at one (1) time: 1	
Are tanker trucks/rail cars pressure tested for leaks at this or any other location? <input type="checkbox"/> Yes <input checked="" type="checkbox"/> No <input type="checkbox"/> Not Required If Yes, Please describe:					
Provide description of closed vent system and any bypasses. Vapors are collected and routed to a vapor combustor.					
Are any of the following truck/rail car loadout systems utilized? <input type="checkbox"/> Closed System to tanker truck/rail car passing a MACT level annual leak test? <input type="checkbox"/> Closed System to tanker truck/rail car passing a NSPS level annual leak test? <input type="checkbox"/> Closed System to tanker truck/rail car not passing an annual leak test and has vapor return?					
Projected Maximum Operating Schedule (for rack or transfer point as a whole)					
Time	Jan – Mar		Apr - Jun		Jul – Sept
Hours/day	24		24		24
Days/week	5		5		5
Bulk Liquid Data (use extra pages as necessary)					
Liquid Name	Produced Water				
Max. Daily Throughput (1000 gal/day)	75.31				
Max. Annual Throughput (1000 gal/yr)	27,488.22				
Loading Method ¹	SUB				
Max. Fill Rate (gal/min)	125				
Average Fill Time (min/loading)	Approx. 60				
Max. Bulk Liquid Temperature (°F)	96.78				
True Vapor Pressure ²	13.5483				
Cargo Vessel Condition ³	U				
Control Equipment or Method ⁴	N/A				
Max. Collection Efficiency (%)	0%				
Max. Control Efficiency (%)	0%				
Max.VOC Emission Rate	Loading (lb/hr)	2.60			
	Annual (ton/yr)	0.39			
Max.HAP Emission Rate	Loading (lb/hr)	0.17			
	Annual (ton/yr)	0.03			
Estimation Method ⁵	EPA/O = ProMax process simulation				

- | | | | | | | |
|---|-----|---|----|---|-----|-------------------------------|
| 1 | BF | Bottom Fill | SP | Splash Fill | SUB | Submerged Fill |
| 2 | | At maximum bulk liquid temperature | | | | |
| 3 | B | Ballasted Vessel | C | Cleaned | U | Uncleaned (dedicated service) |
| | O | Other (describe) | | | | |
| 4 | | List as many as apply (complete and submit appropriate Air Pollution Control Device Sheets) | | | | |
| | CA | Carbon Adsorption | VB | Dedicated Vapor Balance (closed system) | | |
| | ECD | Enclosed Combustion Device | F | Flare | | |
| | TO | Thermal Oxidization or Incineration | | | | |
| 5 | EPA | EPA Emission Factor in AP-42 | MB | Material Balance | | |
| | TM | Test Measurement based upon test data submittal | O | Other (describe) | | |

loading operation, resulting in high levels of vapor generation and loss. If the turbulence is great enough, liquid droplets will be entrained in the vented vapors.

A second method of loading is submerged loading. Two types are the submerged fill pipe method and the bottom loading method. In the submerged fill pipe method, the fill pipe extends almost to the bottom of the cargo tank. In the bottom loading method, a permanent fill pipe is attached to the cargo tank bottom. During most of submerged loading by both methods, the fill pipe opening is below the liquid surface level. Liquid turbulence is controlled significantly during submerged loading, resulting in much lower vapor generation than encountered during splash loading.

The recent loading history of a cargo carrier is just as important a factor in loading losses as the method of loading. If the carrier has carried a nonvolatile liquid such as fuel oil, or has just been cleaned, it will contain vapor-free air. If it has just carried gasoline and has not been vented, the air in the carrier tank will contain volatile organic vapors, which will be expelled during the loading operation along with newly generated vapors.

Cargo carriers are sometimes designated to transport only one product, and in such cases are practicing "dedicated service". Dedicated gasoline cargo tanks return to a loading terminal containing air fully or partially saturated with vapor from the previous load. Cargo tanks may also be "switch loaded" with various products, so that a nonvolatile product being loaded may expel the vapors remaining from a previous load of a volatile product such as gasoline. These circumstances vary with the type of cargo tank and with the ownership of the carrier, the petroleum liquids being transported, geographic location, and season of the year.

One control measure for vapors displaced during liquid loading is called "vapor balance service", in which the cargo tank retrieves the vapors displaced during product unloading at bulk plants or service stations and transports the vapors back to the loading terminal. Figure 5.2-5 shows a tank truck in vapor balance service filling a service station underground tank and taking on displaced gasoline vapors for return to the terminal. A cargo tank returning to a bulk terminal in vapor balance service normally is saturated with organic vapors, and the presence of these vapors at the start of submerged loading of the tanker truck results in greater loading losses than encountered during nonvapor balance, or "normal", service. Vapor balance service is usually not practiced with marine vessels, although some vessels practice emission control by means of vapor transfer within their own cargo tanks during ballasting operations, discussed below.

Emissions from loading petroleum liquid can be estimated (with a probable error of ± 30 percent)⁴ using the following expression:

$$L_L = 12.46 \frac{SPM}{T} \quad (1)$$

where:

L_L = loading loss, pounds per 1000 gallons ($\text{lb}/10^3 \text{ gal}$) of liquid loaded

S = a saturation factor (see Table 5.2-1)

P = true vapor pressure of liquid loaded, pounds per square inch absolute (psia)
(see Figure 7.1-5, Figure 7.1-6, and Table 7.1-2)

M = molecular weight of vapors, pounds per pound-mole ($\text{lb}/\text{lb-mole}$) (see Table 7.1-2)

T = temperature of bulk liquid loaded, $^{\circ}\text{R}$ ($^{\circ}\text{F} + 460$)

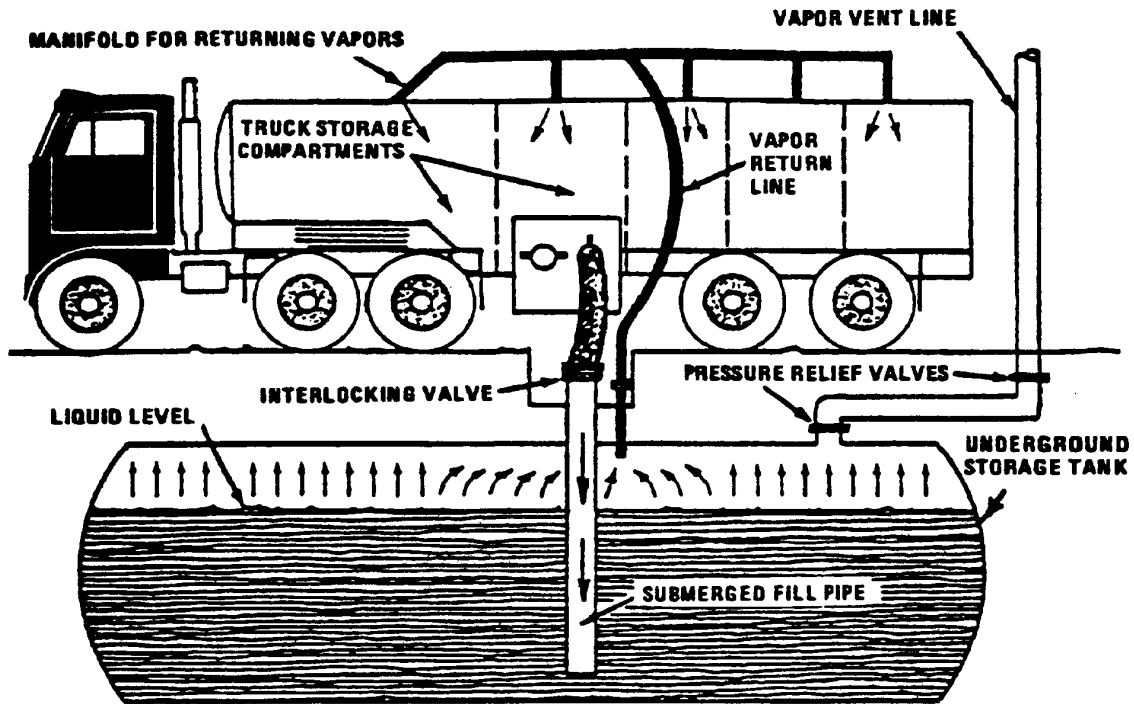

Figure 5.2-5. Tank truck unloading into a service station underground storage tank and practicing "vapor balance" form of emission control.

Table 5.2-1. SATURATION (S) FACTORS FOR CALCULATING PETROLEUM LIQUID LOADING LOSSES

Cargo Carrier	Mode Of Operation	S Factor
Tank trucks and rail tank cars	Submerged loading of a clean cargo tank	0.50
	Submerged loading: dedicated normal service	0.60
	Submerged loading: dedicated vapor balance service	1.00
	Splash loading of a clean cargo tank	1.45
	Splash loading: dedicated normal service	1.45
	Splash loading: dedicated vapor balance service	1.00
Marine vessels ^a	Submerged loading: ships	0.2
	Submerged loading: barges	0.5

^a For products other than gasoline and crude oil. For marine loading of gasoline, use factors from Table 5.2-2. For marine loading of crude oil, use Equations 2 and 3 and Table 5.2-3.

ATTACHMENT Q: PNEUMATIC CONTROLLERS DATA SHEET

**ATTACHMENT Q – PNEUMATIC CONTROLLERS
DATA SHEET**

Are there any continuous bleed natural gas driven pneumatic controllers at this facility that commenced construction, modification or reconstruction after August 23, 2011, and on or before September 18, 2015?

Yes No

Please list approximate number.

Are there any continuous bleed natural gas driven pneumatic controllers at this facility that commenced construction, modification or reconstruction after September 18, 2015?

Yes No

Please list approximate number.

Are there any continuous bleed natural gas driven pneumatic controllers at this facility with a bleed rate greater than 6 standard cubic feet per hour that are required based on functional needs, including but not limited to response time, safety and positive actuation that commenced construction, modification or reconstruction after August 23, 2011, and on or before September 18, 2015?

Yes No

Please list approximate number.

Are there any continuous bleed natural gas driven pneumatic controllers at this facility with a bleed rate greater than 6 standard cubic feet per hour that are required based on functional needs, including but not limited to response time, safety and positive actuation that commenced construction, modification or reconstruction after September 18, 2015?

Yes No

Please list approximate number.

ATTACHMENT R: PNEUMATIC PUMP DATA SHEET

**ATTACHMENT R – PNEUMATIC PUMP
DATA SHEET**

Are there any natural gas-driven diaphragm pumps located at a well site that commenced construction, modification or reconstruction after September 18, 2015?

Yes No

Please list.

Source ID #	Date	Pump Make/Model	Pump Size

**ATTACHMENT S: AIR POLLUTION CONTROL DEVICE/EMISSION REDUCTION
DEVICES SHEETS**

VAPOR COMBUSTION

AP-42 EMISSION FACTORS

**ATTACHMENT S – AIR POLLUTION CONTROL DEVICE /
EMISSION REDUCTION DEVICE SHEETS**

Complete the applicable air pollution control device sheets for each flare, vapor combustor, thermal oxidizer, condenser, adsorption system, vapor recovery unit, BTEX Eliminator, Reboiler with and without Glow Plug, etc. at the facility. Use extra pages if necessary.

Emissions calculations must be performed using the most conservative control device efficiency.

The following five (5) rows are only to be completed if registering an alternative air pollution control device.

Emission Unit ID:	Make/Model:
Primary Control Device ID:	Make/Model:
Control Efficiency (%):	APCD/ERD Data Sheet Completed: <input type="checkbox"/> Yes <input type="checkbox"/> No
Secondary Control Device ID:	Make/Model:
Control Efficiency (%):	APCD/ERD Data Sheet Completed: <input type="checkbox"/> Yes <input type="checkbox"/> No

VAPOR COMBUSTION (Including Enclosed Combustors)

General Information

Control Device ID#: APC-COMB	Installation Date: TBD <input checked="" type="checkbox"/> New <input type="checkbox"/> Modified <input type="checkbox"/> Relocated	
Maximum Rated Total Flow Capacity 11,666.7 scfh 280,000 scfd	Maximum Design Heat Input (from mfg. spec sheet) 24.0 MMBTU/hr	Design Heat Content 2,682 BTU/scf

Control Device Information

Type of Vapor Combustion Control?		
<input checked="" type="checkbox"/> Enclosed Combustion Device <input type="checkbox"/> Thermal Oxidizer	<input type="checkbox"/> Elevated Flare	<input type="checkbox"/> Ground Flare
Manufacturer: Cimarron Model: Low Pro 300	Hours of operation per year? 8,760	

List the emission units whose emissions are controlled by this vapor control device (Emission Point ID# APC-COMB)

Emission Unit ID#	Emission Source Description	Emission Unit ID#	Emission Source Description
EU-TANKS-COND	Condensate Tanks	EU-LOAD-COND	Condensate Truck Loading
EU-TANKS-PW	Produced Water Tanks		

If this vapor combustor controls emissions from more than six (6) emission units, please attach additional pages.

Assist Type (Flares only)	Flare Height	Tip Diameter	Was the design per §60.18?
<input type="checkbox"/> Steam <input type="checkbox"/> Air <input type="checkbox"/> Pressure <input checked="" type="checkbox"/> Non	12 feet	N/A feet	<input type="checkbox"/> Yes <input checked="" type="checkbox"/> No Provide determination.

Waste Gas Information

Maximum Waste Gas Flow Rate 194.4 (scfm)	Heat Value of Waste Gas Stream 2,682 BTU/ft ³	Exit Velocity of the Emissions Stream (ft/s)
---	---	---

Provide an attachment with the characteristics of the waste gas stream to be burned.

Pilot Gas Information

Number of Pilot Lights 4	Fuel Flow Rate to Pilot Flame per Pilot 50 scfh	Heat Input per Pilot 45,250 BTU/hr	Will automatic re-ignition be used? <input checked="" type="checkbox"/> Yes <input type="checkbox"/> No
-----------------------------	--	---------------------------------------	--

If automatic re-ignition is used, please describe the method. If the pilot flame is lost, the control system will automatically attempt to relight the pilot. If the re-ignition attempt fails, the pilot solenoid valve will automatically close and a local remote alarm signal will be generated to indicate loss of pilot flame.

Is pilot flame equipped with a monitor to detect the presence of the flame? <input checked="" type="checkbox"/> Yes <input type="checkbox"/> No	If Yes, what type? <input type="checkbox"/> Thermocouple <input type="checkbox"/> Infrared <input type="checkbox"/> Ultraviolet <input type="checkbox"/> Camera <input checked="" type="checkbox"/> Other: flame rod
---	---

Describe all operating ranges and maintenance procedures required by the manufacturer to maintain the warranty. *(If unavailable, please indicate).*

Additional information attached? <input checked="" type="checkbox"/> Yes <input type="checkbox"/> No
Please attach copies of manufacturer's data sheets, drawings, flame demonstration per §60.18 or §63.11(b) and performance testing.



ITEM 1: 7'x 30' Enclosed Flare 500MSCFD

Combustor Data

- Dimensions: 7'D x 30'L s/s
- MAWP 10 psig
- MMBTU/HR 53 MMBTU/HR
- Burner Staged Combustion w/ removable trays
- Flame Arrestor 4" Wenco
- Structure Carbon Steel Shell w/ 3" Fiber Frax 2300°F Insulation
- Base Precast Concrete Foundation 10'x10'x12"
- Inlet Connection 4" NPT
- Pilot Regulator ½" Watts

Item #1: Pricing		
Description	Qty	Extended Price
7'x 30' Enclosed Flare 500MSCFD	1	\$59,675

Terms/Delivery
Subject To Prior Sale / 12 weeks ARO, Ex Works Mfg Facility

ITEM 2: Low Pro 300 Enclosed Combustor

Combustor Data

- Dimensions 96"W x 144"L x 144"H
- MAWP Atmospheric
- MMBTU/HR 24 MMBTU/HR
- Jets (Qty 4) 480 SS Jets
- Flamecells (Qty 10) 40" x 4"
- Burner (Qty 4)-34"Lx41"W
- Flame Arrestor (Qty 2) 3" Wenco
- Concrete Blocks (Qty 3)-12"Wx9"Hx96"L
- Inlet Connection 3" NPT
- Pilot Regulator ¼" Fisher 67CR-206

Item #2: Pricing		
Description	Qty	Extended Price
Low Pro 300 Enclosed Combustor	1	\$46,500

Quote 14014 Rev1

[3]
Cimarron Energy, 2016

Confidential



Model Low Pro 300

Operational Design

Upper Operating Flow rate: 280 MSCFD*
Lower Operating Flow rate: 12 MSCFD*
Destruction efficiency: Testing on going. Designed destruction efficiency 99.999%

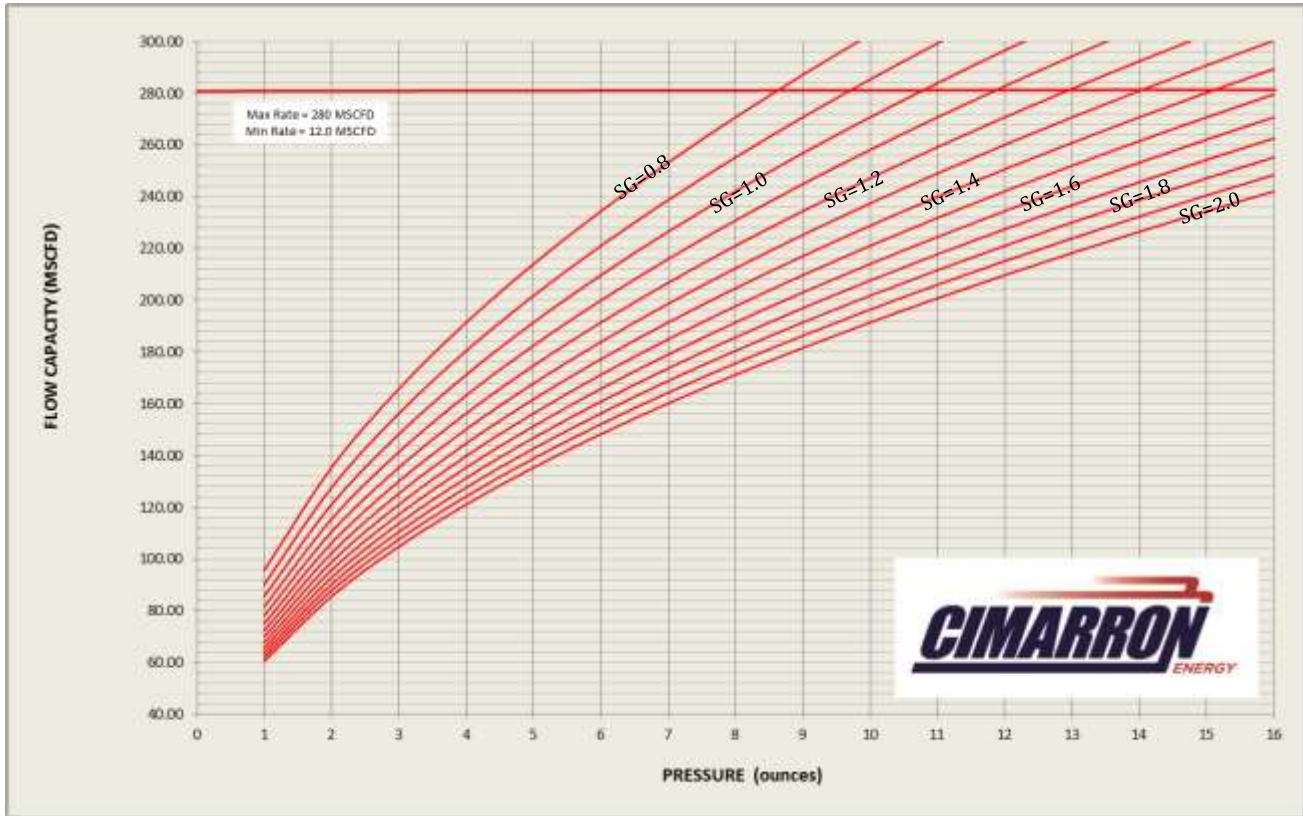

*minimum net heating value of 1000 Btu/scf

Mechanical Design

Overall Dimensions: 12'L x 8.5'W x 11'H
Weight: 8000 lbs. (excludes concrete)
Burner: 4 Burn Rails x 480 Jets each
Ambient Temperature: -20 to 120 F
Electrical Area Classification: Non-hazardous

Options

- Attachable Drip Pot with auto/manual drain
- Dual inlet piping to handle multiple gas streams



Since flares do not lend themselves to conventional emission testing techniques, only a few attempts have been made to characterize flare emissions. Recent EPA tests using propylene as flare gas indicated that efficiencies of 98 percent can be achieved when burning an offgas with at least 11,200 kJ/m³ (300 Btu/ft³). The tests conducted on steam-assisted flares at velocities as low as 39.6 meters per minute (m/min) (130 ft/min) to 1140 m/min (3750 ft/min), and on air-assisted flares at velocities of 180 m/min (617 ft/min) to 3960 m/min (13,087 ft/min) indicated that variations in incoming gas flow rates have no effect on the combustion efficiency. Flare gases with less than 16,770 kJ/m³ (450 Btu/ft³) do not smoke.

Table 13.5-1 presents flare emission factors, and Table 13.5-2 presents emission composition data obtained from the EPA tests.¹ Crude propylene was used as flare gas during the tests. Methane was a major fraction of hydrocarbons in the flare emissions, and acetylene was the dominant intermediate hydrocarbon species. Many other reports on flares indicate that acetylene is always formed as a stable intermediate product. The acetylene formed in the combustion reactions may react further with hydrocarbon radicals to form polyacetylenes followed by polycyclic hydrocarbons.²

In flaring waste gases containing no nitrogen compounds, NO is formed either by the fixation of atmospheric nitrogen (N) with oxygen (O) or by the reaction between the hydrocarbon radicals present in the combustion products and atmospheric nitrogen, by way of the intermediate stages, HCN, CN, and OCN.² Sulfur compounds contained in a flare gas stream are converted to SO₂ when burned. The amount of SO₂ emitted depends directly on the quantity of sulfur in the flared gases.

Table 13.5-1 (English Units). EMISSION FACTORS FOR FLARE OPERATIONS^a

EMISSION FACTOR RATING: B

Component	Emission Factor (lb/10 ⁶ Btu)
Total hydrocarbons ^b	0.14
Carbon monoxide	0.37
Nitrogen oxides	0.068
Soot ^c	0 - 274

^a Reference 1. Based on tests using crude propylene containing 80% propylene and 20% propane.

^b Measured as methane equivalent.

^c Soot in concentration values: nonsmoking flares, 0 micrograms per liter (µg/L); lightly smoking flares, 40 µg/L; average smoking flares, 177 µg/L; and heavily smoking flares, 274 µg/L.

ATTACHMENT T: EMISSIONS CALCULATIONS

SWN Production Company, LLC
 Robert Bone Pad
 Summary of Criteria Air Pollutant Emissions

Equipment	Unit ID	Emission Point ID	NOx		CO		Total VOC ¹		SO ₂		PM Total	
			lb/hr	TPY	lb/hr	TPY	lb/hr	TPY	lb/hr	TPY	lb/hr	TPY
145-hp Caterpillar G3306 NA Engine	EU-ENG1	EP-ENG1	0.32	1.40	0.64	2.80	0.16	0.69	<0.01	<0.01	0.02	0.11
145-hp Caterpillar G3306 NA Engine	EU-ENG2	EP-ENG2	0.32	1.40	0.64	2.80	0.16	0.69	<0.01	<0.01	0.02	0.11
203-hp Caterpillar G3306 TA Engine	EU-ENG3	EP-ENG3	0.45	1.96	0.90	3.92	0.23	1.00	<0.01	<0.01	0.04	0.16
1.0-mmBtu/hr GPU Burner	EU-GPU1	EP-GPU1	0.11	0.48	0.09	0.41	0.01	0.03	<0.01	<0.01	0.01	0.04
1.0-mmBtu/hr GPU Burner	EU-GPU2	EP-GPU2	0.11	0.48	0.09	0.41	0.01	0.03	<0.01	<0.01	0.01	0.04
1.0-mmBtu/hr GPU Burner	EU-GPU3	EP-GPU3	0.11	0.48	0.09	0.41	0.01	0.03	<0.01	<0.01	0.01	0.04
1.0-mmBtu/hr GPU Burner	EU-GPU4	EP-GPU4	0.11	0.48	0.09	0.41	0.01	0.03	<0.01	<0.01	0.01	0.04
1.5-mmBtu/hr Stabilizer Heater	EU-SH1	EP-SH1	0.17	0.73	0.14	0.61	0.01	0.04	<0.01	<0.01	0.01	0.06
1.5-mmBtu/hr Stabilizer Heater	EU-SH2	EP-SH2	0.17	0.73	0.14	0.61	0.01	0.04	<0.01	<0.01	0.01	0.06
Six (6) 400-bbl Condensate Tanks Routed to Vapor Combustor	EU-TANKS-COND	APC-COMB	-	-	-	-	-	-	-	-	-	-
Six (6) 400-bbl Produced Water Tanks Routed to Vapor Combustor	EU-TANKS-PW	APC-COMB	-	-	-	-	-	-	-	-	-	-
Condensate Truck Loading w/ Vapor Return Routed to Combustor	EU-LOAD-COND	APC-COMB	-	-	-	-	7.37	32.28	-	-	-	-
Produced Water Truck Loading	EU-LOAD-PW	EP-LOAD-PW	-	-	-	-	0.09	0.39	-	-	-	-
24.0-mmBtu/hr Vapor Combustor	APC-COMB	APC-COMB	3.31	14.51	6.61	28.96	5.12	22.43	-	-	0.07	0.30
Vapor Combustor Pilots	EU-PILOTS	APC-COMB	0.02	0.09	0.02	0.07	<0.01	<0.01	<0.01	<0.01	<0.01	0.01
Fugitive Emissions	EU-FUG	EP-FUG	-	-	-	-	1.89	8.26	-	-	-	-
Fugitive Haul Road Emissions	EU-HR	EP-HR	-	-	-	-	-	-	-	-	7.89	25.91
Total =			5.19	22.74	9.45	41.40	15.05	65.93	0.01	0.03	8.10	26.84
Total Minus Fugitives =			5.19	22.74	9.45	41.40	13.17	57.66	0.01	0.03	0.21	0.93

Notes:

¹ Total VOC includes all constituents heavier than Propane (C3+), including hazardous air pollutants (HAP). Speciated HAP presented in following table.

SWN Production Company, LLC
 Robert Bone Pad
 Summary of Hazardous Air Pollutants

Equipment	Unit ID	Estimated Emissions (lb/hr)									
		Acetaldehyde	Acrolein	Benzene	Ethylbenzene	Formaldehyde	Methanol	n-Hexane	Toluene	Xylenes	Total HAP
145-hp Caterpillar G3306 NA Engine	EU-ENG1	<0.01	<0.01	<0.01	<0.01	0.09	<0.01	-	<0.01	<0.01	0.10
145-hp Caterpillar G3306 NA Engine	EU-ENG2	<0.01	<0.01	<0.01	<0.01	0.09	<0.01	-	<0.01	<0.01	0.10
203-hp Caterpillar G3306 TA Engine	EU-ENG3	0.01	<0.01	<0.01	<0.01	0.12	0.01	-	<0.01	<0.01	0.14
1.0-mmBtu/hr GPU Burner	EU-GPU1	-	-	<0.01	-	<0.01	-	<0.01	<0.01	-	<0.01
1.0-mmBtu/hr GPU Burner	EU-GPU2	-	-	<0.01	-	<0.01	-	<0.01	<0.01	-	<0.01
1.0-mmBtu/hr GPU Burner	EU-GPU3	-	-	<0.01	-	<0.01	-	<0.01	<0.01	-	<0.01
1.0-mmBtu/hr GPU Burner	EU-GPU4	-	-	<0.01	-	<0.01	-	<0.01	<0.01	-	<0.01
1.5-mmBtu/hr Stabilizer Heater	EU-SH1	-	-	<0.01	-	<0.01	-	<0.01	<0.01	-	<0.01
1.5-mmBtu/hr Stabilizer Heater	EU-SH2	-	-	<0.01	-	<0.01	-	<0.01	<0.01	-	<0.01
Six (6) 400-bbl Condensate Tanks Routed to Vapor Combustor	EU-TANKS-COND	-	-	-	-	-	-	-	-	-	-
Six (6) 400-bbl Produced Water Tanks Routed to Vapor Combustor	EU-TANKS-PW	-	-	-	-	-	-	-	-	-	-
Condensate Truck Loading w/ Vapor Return Routed to Combustor	EU-LOAD-COND	-	-	<0.01	0.03	-	-	0.38	0.02	0.04	0.48
Produced Water Truck Loading	EU-LOAD-PW	-	-	<0.01	<0.01	-	-	<0.01	<0.01	<0.01	0.01
24.0-mmBtu/hr Vapor Combustor	APC-COMB	-	-	<0.01	0.02	-	-	0.26	0.02	0.03	0.33
Vapor Combustor Pilots	EU-PILOTS	-	-	<0.01	-	<0.01	-	<0.01	<0.01	-	<0.01
Fugitive Emissions	EU-FUG	-	-	<0.01	0.01	-	-	0.08	<0.01	0.01	0.10
Fugitive Haul Road Emissions	EU-HR	-	-	-	-	-	-	-	-	-	-
Total =		0.01	0.01	0.02	0.05	0.29	0.01	0.74	0.05	0.08	1.26

Continued on Next Page

SWN Production Company, LLC
 Robert Bone Pad
 Summary of Hazardous Air Pollutants (Continued)

Equipment	Unit ID	Estimated Emissions (TPY)									
		Acetaldehyde	Acrolein	Benzene	Ethylbenzene	Formaldehyde	Methanol	n-Hexane	Toluene	Xylenes	Total HAP
145-hp Caterpillar G3306 NA Engine	EU-ENG1	0.02	0.01	0.01	<0.01	0.38	0.02	-	<0.01	<0.01	0.44
145-hp Caterpillar G3306 NA Engine	EU-ENG2	0.02	0.01	0.01	<0.01	0.38	0.02	-	<0.01	<0.01	0.44
1.0-mmBtu/hr GPU Burner	EU-GPU1	-	-	<0.01	-	<0.01	-	0.01	<0.01	-	0.01
1.0-mmBtu/hr GPU Burner	EU-GPU2	-	-	<0.01	-	<0.01	-	0.01	<0.01	-	0.01
1.0-mmBtu/hr GPU Burner	EU-GPU3	-	-	<0.01	-	<0.01	-	0.01	<0.01	-	0.01
1.0-mmBtu/hr GPU Burner	EU-GPU4	-	-	<0.01	-	<0.01	-	0.01	<0.01	-	0.01
1.5-mmBtu/hr Stabilizer Heater	EU-SH1	-	-	<0.01	-	<0.01	-	0.01	<0.01	-	0.01
1.5-mmBtu/hr Stabilizer Heater	EU-SH2	-	-	<0.01	-	<0.01	-	0.01	<0.01	-	0.01
Six (6) 400-bbl Condensate Tanks Routed to Vapor Combustor	EU-TANKS-COND	-	-	-	-	-	-	-	-	-	-
Six (6) 400-bbl Produced Water Tanks Routed to Vapor Combustor	EU-TANKS-PW	-	-	-	-	-	-	-	-	-	-
Condensate Truck Loading w/ Vapor Return Routed to Combustor	EU-LOAD-COND	-	-	0.02	0.12	-	-	1.67	0.10	0.18	2.09
Produced Water Truck Loading	EU-LOAD-PW	-	-	<0.01	<0.01	-	-	0.02	<0.01	<0.01	0.03
24.0-mmBtu/hr Vapor Combustor	APC-COMB	-	-	0.01	0.08	-	-	1.16	0.07	0.12	1.45
Vapor Combustor Pilots	EU-PILOTS	-	-	<0.01	-	<0.01	-	<0.01	<0.01	-	<0.01
Fugitive Emissions	EU-FUG	-	-	<0.01	0.02	-	-	0.34	0.02	0.03	0.42
Fugitive Haul Road Emissions	EU-HR	-	-	-	-	-	-	-	-	-	-
Total =		0.05	0.05	0.07	0.23	1.29	0.06	3.25	0.20	0.34	5.54

SWN Production Company, LLC
 Robert Bone Pad
 Summary of Greenhouse Gas Emissions - Metric Tons per Year (Tonnes)

Equipment	Unit ID	Carbon Dioxide (CO ₂)		Methane (CH ₄)		Methane (CH ₄) as CO ₂ Eq.		Nitrous Oxide (N ₂ O)		Nitrous Oxide (N ₂ O) as CO ₂ Eq.		Total CO ₂ + CO ₂ Eq. ¹	
		lb/hr	tonnes/yr	lb/hr	tonnes/yr	lb/hr	tonnes/yr	lb/hr	tonnes/yr	lb/hr	tonnes/yr	lb/hr	tonnes/yr
145-hp Caterpillar G3306 NA Engine	EU-ENG1	155.04	616.04	<0.01	0.01	0.07	0.27	<0.01	<0.01	0.08	0.33	155.19	616.64
145-hp Caterpillar G3306 NA Engine	EU-ENG2	155.04	616.04	<0.01	0.01	0.07	0.27	<0.01	<0.01	0.08	0.33	155.19	616.64
203-hp Caterpillar G3306 TA Engine	EU-ENG3	217.05	862.45	<0.01	0.02	0.10	0.40	<0.01	<0.01	0.12	0.48	217.27	863.33
1.0-mmBtu/hr GPU Burner	EU-GPU1	116.98	464.80	<0.01	0.01	0.06	0.22	<0.01	<0.01	0.07	0.26	117.10	465.28
1.0-mmBtu/hr GPU Burner	EU-GPU2	116.98	464.80	<0.01	0.01	0.06	0.22	<0.01	<0.01	0.07	0.26	117.10	465.28
1.0-mmBtu/hr GPU Burner	EU-GPU3	116.98	464.80	<0.01	0.01	0.06	0.22	<0.01	<0.01	0.07	0.26	117.10	465.28
1.0-mmBtu/hr GPU Burner	EU-GPU4	116.98	464.80	<0.01	0.01	0.06	0.22	<0.01	<0.01	0.07	0.26	117.10	465.28
1.5-mmBtu/hr Stabilizer Heater	EU-SH1	175.47	697.21	<0.01	0.01	0.08	0.33	<0.01	<0.01	0.10	0.39	175.65	697.93
1.5-mmBtu/hr Stabilizer Heater	EU-SH2	175.47	697.21	<0.01	0.01	0.08	0.33	<0.01	<0.01	0.10	0.39	175.65	697.93
Six (6) 400-bbl Condensate Tanks Routed to Vapor Combustor	EU-TANKS-COND	-	-	-	-	-	-	-	-	-	-	-	-
Six (6) 400-bbl Produced Water Tanks Routed to Vapor Combustor	EU-TANKS-PW	-	-	-	-	-	-	-	-	-	-	-	-
Condensate Truck Loading w/ Vapor Return Routed to Combustor	EU-LOAD-COND	<0.01	0.02	0.96	3.82	24.03	95.47	-	-	-	-	24.03	95.48
Produced Water Truck Loading	EU-LOAD-PW	0.02	0.07	3.22	12.81	80.62	320.32	-	-	-	-	80.63	320.39
24.0-mmBtu/hr Vapor Combustor	APC-COMB	2,807.45	11,155.31	0.05	0.21	1.32	5.26	0.01	0.02	1.58	6.27	2,810.35	11,166.83
Vapor Combustor Pilots	EU-PILOTS	21.17	84.13	<0.01	<0.01	0.01	0.04	<0.01	<0.01	0.01	0.05	21.19	84.22
Fugitive Emissions	EU-FUG	0.01	0.03	1.25	4.98	31.31	124.41	-	-	-	-	31.32	124.43
Fugitive Haul Road Emissions	EU-HR	-	-	-	-	-	-	-	-	-	-	-	-
Total =		4,174.62	16,587.71	5.52	21.92	137.91	547.97	0.01	0.03	2.33	9.27	4,314.86	17,144.95

Notes:
¹ CO₂ Equivalent = Pollutant times GWP multiplier. 40 CFR 98 Table A-1, Global Warming Potential (GWP) multiplier (100-Year Time Horizon): CO₂ = 1, CH₄ = 25, N₂O = 298
² Per API Compendium (2009) Chapter 5: Because most of the CH₄ and CO₂ emissions from storage tanks occur as a result of flashing (flashing is controlled by the vapor combustor in this case), working and breathing loss emissions of these gases are very small in production and virtually non-existent in the downstream segments. Vapors from the tanks are routed to the vapor combustor at this site. Therefore, GHG emissions from the tanks are assumed to be negligible.

SWN Production Company, LLC
 Robert Bone Pad
 Summary of Greenhouse Gas Emissions - Short Tons per Year (Tons)

Equipment	Unit ID	Carbon Dioxide (CO ₂)		Methane (CH ₄)		Methane (CH ₄) as CO ₂ Eq.		Nitrous Oxide (N ₂ O)		Nitrous Oxide (N ₂ O) as CO ₂ Eq.		Total CO ₂ + CO ₂ Eq. ¹	
		lb/hr	tons/yr ²	lb/hr	tons/yr ²	lb/hr	tons/yr	lb/hr	tons/yr ²	lb/hr	tons/yr	lb/hr	tons/yr
145-hp Caterpillar G3306 NA Engine	EU-ENG1	155.04	679.06	<0.01	0.01	0.07	0.30	<0.01	<0.01	0.08	0.36	155.19	679.73
145-hp Caterpillar G3306 NA Engine	EU-ENG2	155.04	679.06	<0.01	0.01	0.07	0.30	<0.01	<0.01	0.08	0.36	155.19	679.73
203-hp Caterpillar G3306 TA Engine	EU-ENG3	217.05	950.69	<0.01	0.02	0.10	0.44	<0.01	<0.01	0.12	0.53	217.27	951.66
1.0-mmBtu/hr GPU Burner	EU-GPU1	116.98	512.36	<0.01	0.01	0.06	0.24	<0.01	<0.01	0.07	0.29	117.10	512.89
1.0-mmBtu/hr GPU Burner	EU-GPU2	116.98	512.36	<0.01	0.01	0.06	0.24	<0.01	<0.01	0.07	0.29	117.10	512.89
1.0-mmBtu/hr GPU Burner	EU-GPU3	116.98	512.36	<0.01	0.01	0.06	0.24	<0.01	<0.01	0.07	0.29	117.10	512.89
1.0-mmBtu/hr GPU Burner	EU-GPU4	116.98	512.36	<0.01	0.01	0.06	0.24	<0.01	<0.01	0.07	0.29	117.10	512.89
1.5-mmBtu/hr Stabilizer Heater	EU-SH1	175.47	768.54	<0.01	0.01	0.08	0.36	<0.01	<0.01	0.10	0.43	175.65	769.33
1.5-mmBtu/hr Stabilizer Heater	EU-SH2	175.47	768.54	<0.01	0.01	0.08	0.36	<0.01	<0.01	0.10	0.43	175.65	769.33
Six (6) 400-bbl Condensate Tanks Routed to Vapor Combustor	EU-TANKS-COND	-	-	-	-	-	-	-	-	-	-	-	-
Six (6) 400-bbl Produced Water Tanks Routed to Vapor Combustor	EU-TANKS-PW	-	-	-	-	-	-	-	-	-	-	-	-
Condensate Truck Loading w/ Vapor Return Routed to Combustor	EU-LOAD-COND	<0.01	0.02	0.96	4.21	24.03	105.23	-	-	-	-	24.03	105.25
Produced Water Truck Loading	EU-LOAD-PW	0.02	0.07	3.22	14.12	80.62	353.10	-	-	-	-	80.63	353.17
24.0-mmBtu/hr Vapor Combustor	APC-COMB	2,807.45	12,296.63	0.05	0.23	1.32	5.79	0.01	0.02	1.58	6.91	2,810.35	12,309.33
Vapor Combustor Pilots	EU-PILOTS	21.17	92.74	<0.01	<0.01	0.01	0.04	<0.01	<0.01	0.01	0.05	21.19	92.83
Fugitive Emissions	EU-FUG	0.01	0.03	1.25	5.49	31.31	137.13	-	-	-	-	31.32	137.16
Fugitive Haul Road Emissions	EU-HR	-	-	-	-	-	-	-	-	-	-	-	-
Total =		4,174.62	18,284.82	5.52	24.16	137.91	604.04	0.01	0.03	2.33	10.22	4,314.86	18,899.07

Notes:
¹ CO₂ Equivalent = Pollutant times GWP multiplier. 40 CFR 98 Table A-1, Global Warming Potential (GWP) multiplier (100-Year Time Horizon): CO₂ = 1, CH₄ = 25, N₂O = 298
² EPA and API GHG calculation methodologies calculate emissions in metric tons (tonnes). These values have been converted to short tons for consistency with permitting threshold units.
³ Per API Compendium (2009) Chapter 5: Because most of the CH₄ and CO₂ emissions from storage tanks occur as a result of flashing (flashing is controlled by the vapor combustor in this case), working and breathing loss emissions of these gases are very small in production and virtually non-existent in the downstream segments. Vapors from the tanks are routed to the vapor combustor at this site. Therefore, GHG emissions from the tanks are assumed to be negligible.

SWN Production Company, LLC
Robert Bone Pad
Engine Emissions Calculations - Criteria Air Pollutants

Equipment Information

	<u>EU-ENG1</u>	<u>EU-ENG2</u>	<u>EU-ENG3</u>
Unit ID:	EP-ENG1	EP-ENG2	EP-ENG3
Emission Point ID:	Caterpillar	Caterpillar	Caterpillar
Make:	G3306 NA	G3306 NA	G3306 TA
Model:	4S-RB	4S-RB	4S-RB
Design Class:	NSCR	NSCR	NSCR
Controls:	145	145	203
Horsepower (hp):	8,625	8,625	9,015
Fuel Use (Btu/hp-hr):	1,382	1,382	2,022
Fuel Use (scfh):	12.11	12.11	17.71
Annual Fuel Use (mmscf):	1.25	1.25	1.83
Fuel Use (mmBtu/hr):	678	678	1,002
Exhaust Flow (acfm):	1,101	1,101	1,096
Exhaust Temp (°F):	after 1/1/2011	after 1/1/2011	after 1/1/2011
Manufacture Date:	8,760	8,760	8,760
Operating Hours:	905	905	905
Fuel Heating Value (Btu/scf):			

Uncontrolled Manufacturer Emission Factors ¹

NOx (g/hp-hr):	13.47	13.47	15.79
CO (g/hp-hr):	13.47	13.47	15.79
NMNEHC/VOC (g/hp-hr):	0.22	0.22	0.26
Total VOC = NMNEHC + HCHO (g/hp-hr):	0.49	0.49	0.51

Post-Catalyst Emission Factors

NOx Control Eff. %	92.58%	92.58%	93.67%
CO Control Eff. %	85.15%	85.15%	87.33%
VOC Control Eff. %	0.00%	0.00%	0.00%
NOx (g/hp-hr):	1.00	1.00	1.00
CO (g/hp-hr):	2.00	2.00	2.00
NMNEHC/VOC (g/hp-hr):	0.22	0.22	0.26
Total VOC = NMNEHC + HCHO (g/hp-hr):	0.49	0.49	0.51

Uncontrolled Criteria Air Pollutant Emissions

	Unit ID:	<u>EU-ENG1</u>	<u>EU-ENG2</u>	<u>EU-ENG3</u>			
Pollutant		lb/hr	TPY	lb/hr	TPY	lb/hr	TPY
NOx		4.31	18.86	4.31	18.86	7.07	30.95
CO		4.31	18.86	4.31	18.86	7.07	30.95
NMNEHC/VOC (does not include HCHO)		0.07	0.31	0.07	0.31	0.12	0.51
Total VOC (includes HCHO)		0.16	0.69	0.16	0.69	0.23	1.00
SO ₂		<0.01	<0.01	<0.01	<0.01	<0.01	<0.01
PM _{10/2.5}		0.01	0.05	0.01	0.05	0.02	0.08
PM _{COND}		0.01	0.05	0.01	0.05	0.02	0.08
PM _{TOT}		0.02	0.11	0.02	0.11	0.04	0.16

**SWN Production Company, LLC
 Robert Bone Pad
 Engine Emissions Calculations - Criteria Air Pollutants (Continued)**

Proposed Criteria Air Pollutant Emissions²

Pollutant	lb/hr	TPY	lb/hr	TPY	lb/hr	TPY
NO _x	0.32	1.40	0.32	1.40	0.45	1.96
CO	0.64	2.80	0.64	2.80	0.90	3.92
NMNEHC/VOC (does not include HCHO)	0.07	0.31	0.07	0.31	0.12	0.51
Total VOC (includes HCHO)	0.16	0.69	0.16	0.69	0.23	1.00
SO ₂	<0.01	<0.01	<0.01	<0.01	<0.01	<0.01
PM _{10/2.5}	0.01	0.05	0.01	0.05	0.02	0.08
PM _{COND}	0.01	0.05	0.01	0.05	0.02	0.08
PM _{TOT}	0.02	0.11	0.02	0.11	0.04	0.16

AP-42 Emission Factors (lb/mmBtu)³

4S-RB

Pollutant	3.2-3 (7/00)
SO ₂	5.88E-04
PM _{10/2.5}	9.50E-03
PM _{COND}	9.91E-03
PM _{TOT}	1.94E-02

Notes:

¹ Uncontrolled emission factors based on engine manufacturer data. Per Caterpillar, NMNEHC emission factor does not include formaldehyde (HCHO); therefore, NMNEHC and HCHO factors have been added to demonstrate total uncontrolled VOC. All other pollutants calculated using AP-42.

² Post-catalyst emission factors for the Caterpillar engines are based on catalyst manufacturer data and/or NSPS Subpart JJJJ limits, if applicable. Per NSPS Subpart JJJJ, VOC limit does not include HCHO; therefore, HCHO emissions have been added to the NSPS JJJJ VOC emission rates for demonstration purposes only.

³ Per AP-42, all particulate matter (PM) from combustion of natural gas (total, condensable and filterable PM) is presumed <1 micrometer in diameter.

**SWN Production Company, LLC
 Robert Bone Pad
 Engine Emissions Calculations - Greenhouse Gases**

Equipment Information

	<u>EU-ENG1</u>	<u>EU-ENG2</u>	<u>EU-ENG3</u>
Unit ID:	EP-ENG1	EP-ENG2	EP-ENG3
Emission Point ID:	Caterpillar	Caterpillar	Caterpillar
Make:	G3306 NA	G3306 NA	G3306 TA
Model:	4S-RB	4S-RB	4S-RB
Design Class:	145	145.0	203.0
Horsepower (hp):	8,625	8,625	9,015
Fuel Use (Btu/hp-hr):	NA	NA	NA
Fuel Use (Btu/kW-hr):	1,382	1,382	2,022
Fuel Use (scfh):	1.25	1.25	1.83
Fuel Use (mmBtu/hr):	678	678	1,002
Exhaust Flow (acfm):	1,101	1,101	1,096
Exhaust Temp (°F):	8,760	8,760	8,760
Operating Hours:			

Manufacturer Emission Factors (g/hp-hr)¹

CO ₂ =	485	485	569
-------------------	-----	-----	-----

Greenhouse Gas (GHG) Emissions¹

Pollutant	lb/hr	tonnes/yr	lb/hr	tonnes/yr	lb/hr	tonnes/yr
CO ₂	155.04	616.04	155.04	616.04	217.05	862.45
CH ₄	<0.01	0.01	<0.01	0.01	<0.01	0.02
N ₂ O	<0.01	<0.01	<0.01	<0.01	<0.01	<0.01
CH ₄ as CO ₂ e	0.07	0.27	0.07	0.27	0.10	0.40
N ₂ O as CO ₂ e	0.08	0.33	0.08	0.33	0.12	0.48
Total CO₂ + CO₂e =	155.19	616.64	155.19	616.64	217.27	863.33

40 CFR 98 Tables ENG-1 Emission Factors (kg/mmBtu)²

Methane (CH ₄)	1.00E-03
Nitrous Oxide (N ₂ O)	1.00E-04

Notes:

¹ Caterpillar manufacturer data used to estimate CO₂ emissions for the Caterpillar engines. All other emissions estimated using EPA data. Conversion to short tons (tons) found in site-wide Summary of Greenhouse Gases - Short Tons per Year (tons) table.

² CO₂e = CO₂ equivalent (Pollutant times GWP multiplier):

40 CFR 98 Table A-1, Global Warming Potential (GWP) multiplier: CO₂ = 1, CH₄ = 25, N₂O = 298

**SWN Production Company, LLC
 Robert Bone Pad
 Gas Production Unit Burner Emissions Calculations - Criteria Air Pollutants**

Equipment Information

Unit ID:	<u>EU-GPU1 - EU-GPU4 (EACH)</u>
Emission Point ID:	EP-GPU1 - EP-GPU4
Description:	Gas Production Unit Burner
Number of Units:	4
Burner Design (mmBtu/hr):	1.0
Fuel HHV (Btu/scf):	905
Annual Fuel Use (mmscf):	9.68
Annual Operating Hours:	8,760

Criteria Air Pollutant Emissions

Unit ID: **EU-GPU1 - EU-GPU4 (EACH)**

Pollutant	lb/hr	TPY
NO _x	0.11	0.48
CO	0.09	0.41
VOC	0.01	0.03
SO ₂	<0.01	<0.01
PM _{10/2.5}	0.01	0.03
PM _{COND}	<0.01	0.01
PM _{TOT}	0.01	0.04

AP-42 Emission Factors for Units <100 mmBtu/hr (lb/mmscf)¹

Pollutant	1.4-1, -2 (7/98)
NO _x	100.0
CO	84.0
VOC	5.5
SO ₂	0.6
PM _{10/2.5}	5.7
PM _{COND}	1.9
PM _{TOT}	7.6

Notes:

¹ All PM (total, condensable and filterable) is assumed to be <1 micrometer in diameter. Total PM is the sum of filterable PM and condensable PM.

**SWN Production Company, LLC
 Robert Bone Pad
 Gas Production Unit Burner Emissions Calculations - Hazardous Air Pollutants**

Equipment Information

Unit ID: **EU-GPU1 - EU-GPU4 (EACH)**
 Emission Point ID: EP-GPU1 - EP-GPU4
 Description: Gas Production Unit Burner
 Number of Units: 4
 Burner Design (mmBtu/hr): 1.0
 Fuel HHV (Btu/scf): 905
 Annual Fuel Use (mmscf): 9.68
 Annual Operating Hours: 8,760

Hazardous Air Pollutant Emissions

Unit ID: **EU-GPU1 - EU-GPU4 (EACH)**

Pollutant	lb/hr	TPY
n-Hexane	<0.01	0.01
Formaldehyde	<0.01	<0.01
Benzene	<0.01	<0.01
Toluene	<0.01	<0.01
Total HAP =	<0.01	0.01

AP-42 Emission Factors (lb/mmscf)

Pollutant	1.4-3 (7/98)
n-Hexane	1.80E+00
Formaldehyde	7.50E-02
Benzene	2.10E-03
Toluene	3.40E-03

**SWN Production Company, LLC
 Robert Bone Pad
 Gas Production Unit Burner Emissions Calculations - Greenhouse Gases**

Equipment Information

Unit ID:	<u>EU-GPU1 - EU-GPU4 (EACH)</u>
Emission Point ID:	EP-GPU1 - EP-GPU4
Description:	Gas Production Unit Burner
Number of Units:	4
Burner Design (mmBtu/hr):	1.0
Fuel HHV (Btu/scf):	905
Annual Fuel Use (mmscf):	9.68
Annual Operating Hours:	8,760

Greenhouse Gas (GHG) Emissions¹

Unit ID: **EU-GPU1 - EU-GPU4 (EACH)**

Pollutant	lb/hr	tonnes/yr
CO ₂	116.98	464.80
CH ₄	<0.01	0.01
N ₂ O	<0.01	<0.01
CH ₄ as CO ₂ e	0.06	0.22
N ₂ O as CO ₂ e	0.07	0.26
Total CO₂ + CO₂e =	117.10	465.28

40 CFR 98 Tables C-1 and C-2 Emission Factors (kg/mmBtu)²

Carbon Dioxide (CO ₂)	53.06
Methane (CH ₄)	1.00E-03
Nitrous Oxide (N ₂ O)	1.00E-04

Notes:

¹ Conversion to short tons (tons) found in site-wide Summary of Greenhouse Gases - Short Tons per Year (tons) table.

² CO₂e = CO₂ equivalent (Pollutant times GWP multiplier):

40 CFR 98 Table A-1, Global Warming Potential (GWP) multiplier: CO₂ = 1, CH₄ = 25, N₂O = 298

**SWN Production Company, LLC
 Robert Bone Pad
 Stabilizer Heater Emissions Calculations - Criteria Air Pollutants**

Equipment Information

Unit ID:	<u>EU-SH1 - EU-SH2</u>
Emission Point ID:	EP-SH1 - EP-SH2
Description:	Stabilizer Heater
Number of Units:	2
Burner Design (mmBtu/hr):	1.5
Fuel HHV (Btu/scf):	905
Annual Fuel Use (mmscf):	14.52
Annual Operating Hours:	8,760

Criteria Air Pollutant Emissions

Unit ID: **EU-SH1 - EU-SH2**

Pollutant	lb/hr	TPY
NO _x	0.17	0.73
CO	0.14	0.61
VOC	0.01	0.04
SO ₂	<0.01	<0.01
PM _{10/2.5}	0.01	0.04
PM _{COND}	<0.01	0.01
PM _{TOT}	0.01	0.06

AP-42 Emission Factors for Units <100 mmBtu/hr (lb/mmscf)¹

Pollutant	1.4-1, -2 (7/98)
NO _x	100.0
CO	84.0
VOC	5.5
SO ₂	0.6
PM _{10/2.5}	5.7
PM _{COND}	1.9
PM _{TOT}	7.6

Notes:

¹ All PM (total, condensable and filterable) is assumed to be <1 micrometer in diameter. Total PM is the sum of filterable PM and condensable PM.

**SWN Production Company, LLC
 Robert Bone Pad
 Stabilizer Heater Emissions Calculations - Hazardous Air Pollutants**

Equipment Information

Unit ID: **EU-SH1 - EU-SH2**
 Emission Point ID: EP-SH1 - EP-SH2
 Description: Stabilizer Heater
 Number of Units: 2
 Burner Design (mmBtu/hr): 1.5
 Fuel HHV (Btu/scf): 905
 Annual Fuel Use (mmscf): 14.52
 Annual Operating Hours: 8,760

Hazardous Air Pollutant Emissions

Unit ID: **EU-SH1 - EU-SH2**

Pollutant	lb/hr	TPY
n-Hexane	<0.01	0.01
Formaldehyde	<0.01	<0.01
Benzene	<0.01	<0.01
Toluene	<0.01	<0.01
Total HAP =	<0.01	0.01

AP-42 Emission Factors (lb/mmscf)

Pollutant	1.4-3 (7/98)
n-Hexane	1.80E+00
Formaldehyde	7.50E-02
Benzene	2.10E-03
Toluene	3.40E-03

**SWN Production Company, LLC
 Robert Bone Pad
 Stabilizer Heater Emissions Calculations - Greenhouse Gases**

Equipment Information

Unit ID:	<u>EU-SH1 - EU-SH2</u>
Emission Point ID:	EP-SH1 - EP-SH2
Description:	Stabilizer Heater
Number of Units:	2
Burner Design (mmBtu/hr):	1.5
Fuel HHV (Btu/scf):	905
Annual Fuel Use (mmscf):	14.52
Annual Operating Hours:	8,760

Greenhouse Gas (GHG) Emissions¹

Unit ID: **EU-SH1 - EU-SH2**

Pollutant	lb/hr	tonnes/yr
CO ₂	175.47	697.21
CH ₄	<0.01	0.01
N ₂ O	<0.01	<0.01
CH ₄ as CO ₂ e	0.08	0.33
N ₂ O as CO ₂ e	0.10	0.39
Total CO₂ + CO₂e =	175.65	697.93

40 CFR 98 Tables C-1 and C-2 Emission Factors (kg/mmBtu)²

Carbon Dioxide (CO ₂)	53.06
Methane (CH ₄)	1.00E-03
Nitrous Oxide (N ₂ O)	1.00E-04

Notes:

¹ Conversion to short tons (tons) found in site-wide Summary of Greenhouse Gases - Short Tons per Year (tons) table.

² CO₂e = CO₂ equivalent (Pollutant times GWP multiplier):

40 CFR 98 Table A-1, Global Warming Potential (GWP) multiplier: CO₂ = 1, CH₄ = 25, N₂O = 298

**SWN Production Company, LLC
Robert Bone Pad
Storage Tank Emissions - Criteria Air Pollutants**

Tank Information

Unit ID:	<u>EU-TANKS-COND</u>	<u>EU-TANKS-PW</u>
Emission Point ID:	APC-COMB	APC-COMB
Contents: ^{1,3}	Condensate	Produced Water
Number of Tanks:	6	6
Capacity (bbl) - Per Tank:	400	400
Capacity (gal) - Per Tank:	16,800	16,800
Total:		
Total Throughput (bbl/yr):	650,175	654,482
Total Throughput (gal/yr):	27,307,329	27,488,223
Total Throughput (bbl/d):	1,781	1,793
Per Tank:		
Throughput (bbl/yr):	108,362	109,080
Throughput (gal/yr):	4,551,222	4,581,371
Throughput (bbl/d):	1,254	1,996
Turnovers:	1,625.44	1,636.20
Tank Vapor Capture Efficiency:	100%	100%
Captured Vapors Routed to:	Vapor Combustor	Vapor Combustor

Uncontrolled Storage Tank Emissions²

Unit ID: **EU-TANKS-COND** **EU-TANKS-PW**

Emissions	lb/hr	TPY	lb/hr	TPY
Working and Breathing Losses	22.55	98.79	0.06	0.28
Flashing Losses	213.84	936.63	2.34	10.25
Total VOC =	236.40	1,035.42	2.40	10.53

Controlled Storage Tank Emissions³

Unit ID: **EU-TANKS-COND** **EU-TANKS-PW**

Emissions	lb/hr	TPY	lb/hr	TPY
Working and Breathing Losses	0.45	1.98	<0.01	0.01
Flashing Losses	4.28	18.73	0.05	0.20
Total VOC =	4.73	20.71	0.05	0.21
Per Tank =	0.79	3.45	0.01	0.04

Notes:

¹ Produced water tanks assumed to contain 99% produced water and 1% condensate.

² Tank working, breathing, and flashing emissions were calculated using Promax process simulation. Reports located in Attachment L. Uncontrolled tank working/breathing/flashing emissions will be routed to a vapor combustor with 100% capture efficiency.

³ Controlled tank emissions are shown for reference only.

**SWN Production Company, LLC
 Robert Bone Pad
 Storage Tank Emissions - Hazardous Air Pollutants**

Uncontrolled Storage Tank Emissions

Unit ID: **EU-TANKS-COND** **EU-TANKS-PW**

Pollutant	lb/hr	TPY	lb/hr	TPY
Total VOC = ^{1,2}	236.40	1,035.42	2.40	10.53
n-Hexane	12.21	53.46	0.12	0.54
Benzene	0.15	0.68	<0.01	0.01
Toluene	0.74	3.23	0.01	0.03
Ethylbenzene	0.89	3.88	0.01	0.04
Xylenes	1.29	5.64	0.01	0.06
Total HAP =	15.27	66.89	0.16	0.68

Controlled Storage Tank Emissions³

Unit ID: **EU-TANKS-COND** **EU-TANKS-PW**

Pollutant	lb/hr	TPY	lb/hr	TPY
Total VOC = ¹	4.73	20.71	0.05	0.21
n-Hexane	0.24	1.07	<0.01	0.01
Benzene	<0.01	0.01	<0.01	<0.01
Toluene	0.01	0.06	<0.01	<0.01
Ethylbenzene	0.02	0.08	<0.01	<0.01
Xylenes	0.03	0.11	<0.01	<0.01
Total HAP =	0.31	1.34	<0.01	0.01

Estimated HAP Composition (% by Weight)⁴

Pollutant	Wt%
n-Hexane	5.163%
Benzene	0.065%
Toluene	0.312%
Ethylbenzene	0.375%
Xylenes	0.545%
Total HAP =	6.460%

Notes:

¹ VOC emissions calculated in Criteria Air Pollutant calculations.

² Uncontrolled condensate tank working/breathing/flashing emissions are controlled by a vapor combustor with 100% capture efficiency.

³ Controlled tank emissions are shown for reference only.

⁴ Speciated liquids analysis located in Fugitive Emissions Calculations. HAP weight % calculated as % of total hydrocarbons in the sample. All HAP assumed to volatilize from liquids for most conservative emissions estimate.

**SWN Production Company, LLC
 Robert Bone Pad
 Tank Emissions Calculations - Greenhouse Gases**

Equipment Information

Unit ID:	<u>EU-TANKS-COND</u>	<u>EU-TANKS-PW</u>
Emission Point ID:	APC-COMB	APC-COMB
Contents: 1,3	Condensate	Produced Water
Number of Tanks:	6	6
Capacity (bbl) - Per Tank:	400	400
Capacity (gal) - Per Tank:	16,800	16,800
Total:		
Total Throughput (bbl/yr):	650,175	654,482
Total Throughput (gal/yr):	27,307,329	27,488,223
Total Throughput (bbl/d):	1,781	1,793
Per Tank:		
Throughput (bbl/yr):	108,362	109,080
Throughput (gal/yr):	4,551,222	4,581,371
Throughput (bbl/d):	1254	1996
Turnovers:	1625.44	1636.20
Tank Vapor Capture Efficiency:	100%	100%
Captured Vapors Routed to:	Vapor Combustor	Vapor Combustor

Uncontrolled Greenhouse Gas Emissions^{1,2}

Unit ID: **EU-TANKS-COND** **EU-TANKS-PW**

Greenhouse Gas	Avg. lb/hr ³	tonnes/yr	Avg. lb/hr ³	tonnes/yr
CH ₄	1.86	7.39	3.61	14.33
CH ₄ as CO ₂ e	46.53	184.87	90.14	358.16
CO ₂	0.09	0.36	0.15	0.60
Total CO₂ + CO₂e =	46.62	185.23	90.29	358.76
Per Tank =	7.77	30.87	15.05	59.79

Greenhouse Gas	Avg. lb/hr ³	tons/yr	Avg. lb/hr ³	tons/yr
CH ₄	1.86	8.15	3.61	15.79
CH ₄ as CO ₂ e	46.53	203.78	90.14	394.81
CO ₂	0.09	0.40	0.15	0.66
Total CO₂ + CO₂e =	46.62	204.18	90.29	395.47
Per Tank =	7.77	34.03	15.05	65.91

**SWN Production Company, LLC
Robert Bone Pad
Tank Emissions Calculations - Greenhouse Gases**

Notes:

1) Per API Chapter 5: CH₄ and CO₂ emissions from crude storage tanks occur mainly as a result of flashing; working and breathing loss emissions of these gases are very small in production and virtually non-existent in downstream segments. Unless site-specific data indicate otherwise, working and breathing losses are presumed to contain no CH₄ or CO₂.

2) CO₂e = CO₂ equivalent (Pollutant times GWP multiplier)

3) Due to variable short-term emission rates, average lb/hr based on annual emissions shown for reference only.

40 CFR 98 Table A-1, Global Warning Potential (GWP) Multiplier

Methane (CH ₄)	25
----------------------------	----

**SWN Production Company, LLC
 Robert Bone Pad
 Condensate Truck Loading Emissions - Criteria and Hazardous Air Pollutants**

Loading Information

Unit ID: **EU-LOAD-COND**
 Emission Point ID: APC-COMB
 Fill Method: Submerged
 Type of Service: Dedicated
 Mode of Operation: Normal
 Saturation Factor: 0.6
 Em. Factor (lb/1000 gal): ¹ 9.03
 Throughput (1000 gal): 27,307.33
 Control Type: Vapor Return/Combustion
 Vapor Capture Efficiency: ¹ 70%
 Average Fill Rate (gal/hr): 7,500
 Captured Vapors Routed to: Vapor Combustor
 VOC Weight %: 84.30%

13.5396	= P, True vapor pressure of liquid loaded (max. psia)
48.17	= M, Molecular weight of vapor (lb/lb-mol)
79.71	= T, Temperature of bulk liquid loaded (average °F)
539.71	= T, Temperature of bulk liquid loaded (°F + 460 = °R)

Uncontrolled Loading Emissions²

Pollutant	Max. lb/hr	Avg. lb/hr	TPY
VOC =	57.12	24.57	107.61
n-Hexane	2.95	1.27	5.56
Benzene	0.04	0.02	0.07
Toluene	0.18	0.08	0.34
Ethylbenzene	0.21	0.09	0.40
Xylenes	0.31	0.13	0.59
Total HAP =	3.69	1.59	6.95

Uncaptured Loading Emissions²

Pollutant	Max. lb/hr	Avg. lb/hr	TPY
VOC =	17.14	7.37	32.28
n-Hexane	0.88	0.38	1.67
Benzene	0.01	<0.01	0.02
Toluene	0.05	0.02	0.10
Ethylbenzene	0.06	0.03	0.12
Xylenes	0.09	0.04	0.18
Total HAP =	1.11	0.48	2.09

**SWN Production Company, LLC
 Robert Bone Pad
 Condensate Truck Loading Emissions - Criteria and Hazardous Air Pollutants (Continued)**

Estimated HAP Composition (% by Weight)³

Pollutant	Wt%
n-Hexane	5.163%
Benzene	0.065%
Toluene	0.312%
Ethylbenzene	0.375%
Xylenes	0.545%
Total HAP =	6.460%

Notes:

¹ Uncontrolled emissions that are captured by the collection system are routed to a vapor combustor. Per AP-42 5.2-6, 70% capture efficiency can be assumed for trucks not subject to NSPS. Uncaptured emissions shown represent those not captured by the collection system or controlled by the vapor combustor.

² Maximum lb/hr based on average hourly truck loading rate. Average lb/hr based on TPY conversion assuming continuous operation.

³ Speciated liquids analysis located in Fugitive Emissions Calculations. HAP weight % calculated as % of total hydrocarbons in the sample. All HAP assumed to volatilize from liquids for most conservative emissions estimate.

**SWN Production Company, LLC
 Robert Bone Pad
 Condensate Truck Loading Emissions - Greenhouse Gases**

Loading Information

Unit ID:	<u>EU-LOAD-COND</u>
Emission Point ID:	APC-COMB
Fill Method:	Submerged
Type of Service:	Dedicated
Mode of Operation:	Normal
TOC Em. Factor (tonne/10 ⁶ gal): ¹	0.91
Throughput (10 ⁶ gal):	27.307
Control Type:	Vapor Return/Combustion
Vapor Capture Efficiency: ²	70.00%
Average Fill Rate (gal/hr):	7,500
Captured Vapors Routed to:	Vapor Combustor

Analysis CH ₄ wt% =	51.22273%
Analysis CO ₂ wt% =	0.26415%

Uncontrolled Loading Emissions^{3,4}

Pollutant	Max. lb/hr	Avg. lb/hr	tonnes/yr	tons/yr
CH ₄	7.71	3.20	12.73	14.03
CH ₄ as CO ₂ e	192.68	80.09	318.22	350.77
CO ₂	0.04	0.02	0.07	0.07
Total CO₂ + CO₂e =	192.72	80.10	318.28	350.85

Uncaptured Loading Emissions^{3,4}

Pollutant	Max. lb/hr	Avg. lb/hr	tonnes/yr	tons/yr
CH ₄	2.31	0.96	3.82	4.21
CH ₄ as CO ₂ e	57.80	24.03	95.47	105.23
CO ₂	0.01	<0.01	0.02	0.02
Total CO₂ + CO₂e =	57.82	24.03	95.48	105.25

**SWN Production Company, LLC
 Robert Bone Pad
 Condensate Truck Loading Emissions - Greenhouse Gases (Continued)**

API Compendium Table 5-12

Loading Type	Emission Factor (tonne TOC/10⁶ gal)
Rail/Truck - Submerged Loading - Dedicated Normal Service	0.91
Rail/Truck - Submerged Loading - Vapor Balance Service	1.51
Rail/Truck - Splash Loading - Dedicated Normal Service	2.20
Rail/Truck - Splash Loading - Vapor Balance Service	1.51
Marine Loading - Ships/Ocean Barges	0.28
Marine Loading - Barges	0.45

Notes:

¹ API Compendium of Greenhouse Gas Emissions Methodologies for the Oil and Gas Industry, Table 5-12.

² Uncontrolled emissions that are captured by the collection system are routed to a vapor combustor. Per AP-42 5.2-6, 70% capture efficiency can be assumed for trucks not subject to NSPS. Uncaptured emissions shown represent those not captured by the collection system or controlled by the vapor combustor.

³ Maximum lb/hr based on average hourly truck loading rate. Average lb/hr based on TPY conversion assuming continuous operation.

⁴ CO₂e = CO₂ equivalent (Pollutant times GWP multiplier):

40 CFR 98 Table A-1, Global Warming Potential (GWP) multiplier: CO₂ = 1, CH₄ = 25

**SWN Production Company, LLC
 Robert Bone Pad
 Produced Water Truck Loading Emissions - Criteria and Hazardous Air Pollutants**

Loading Information

Unit ID:	<u>EU-LOAD-PW</u>
Emission Point ID:	EP-LOAD-PW
Fill Method:	Submerged
Type of Service:	Dedicated
Mode of Operation:	Normal
Saturation Factor:	0.6
Em. Factor (lb/1000 gal):	3.94
Throughput (1000 gal):	27,488.22
Control Type:	None
Average Fill Rate (gal/hr):	7,500
VOC Weight %:	8.80%

13.5483	= P, True vapor pressure of liquid loaded (max. psia)
21.63	= M, Molecular weight of vapor (lb/lb-mol)
96.78	= T, Temperature of bulk liquid loaded (average °F)
556.78	= T, Temperature of bulk liquid loaded (°F + 460 = °R)

Uncontrolled Loading Emissions¹

Pollutant	Max. lb/hr	Avg. lb/hr	TPY
VOC =	2.60	0.09	0.39
n-Hexane	0.13	<0.01	0.02
Benzene	<0.01	<0.01	<0.01
Toluene	0.01	<0.01	<0.01
Ethylbenzene	0.01	<0.01	<0.01
Xylenes	0.01	<0.01	<0.01
Total HAP =	0.17	0.01	0.03

Estimated HAP Composition (% by Weight)²

Pollutant	Wt%
n-Hexane	5.163%
Benzene	0.065%
Toluene	0.312%
Ethylbenzene	0.375%
Xylenes	0.545%
Total HAP =	6.460%

Notes:

¹ Maximum lb/hr based on average hourly truck loading rate. Average lb/hr based on TPY conversion assuming continuous operation.

² Speciated liquids analysis located in Fugitive Emissions Calculations. HAP weight % calculated as % of total hydrocarbons in the sample. All HAP assumed to volatilize from liquids for most conservative emissions estimate.

**SWN Production Company, LLC
 Robert Bone Pad
 Produced Water Truck Loading Emissions - Greenhouse Gases**

Loading Information

Unit ID: **EU-LOAD-PW**
 Emission Point ID: APC-COMB
 Fill Method: Submerged
 Type of Service: Dedicated
 Mode of Operation: Normal
 TOC Em. Factor (tonne/10⁶ gal): ¹ 0.91
 Throughput (10⁶ gal): 27.4882
 Control Type: None
 Average Fill Rate (gal/hr): 7,500

Analysis CH ₄ wt% =	51.22273%
Analysis CO ₂ wt% =	0.26415%

Uncontrolled Loading Emissions^{2,3}

Pollutant	Max. lb/hr	Avg. lb/hr	tonnes/yr	tons/yr
CH ₄	7.71	3.22	12.81	14.12
CH ₄ as CO ₂ e	192.68	80.62	320.32	353.10
CO ₂	0.04	0.02	0.07	0.07
Total CO₂ + CO₂e =	192.72	80.63	320.39	353.17

API Compendium Table 5-12

Loading Type	Emission Factor (tonne TOC/10 ⁶ gal)
Rail/Truck - Submerged Loading - Dedicated Normal Service	0.91
Rail/Truck - Submerged Loading - Vapor Balance Service	1.51
Rail/Truck - Splash Loading - Dedicated Normal Service	2.20
Rail/Truck - Splash Loading - Vapor Balance Service	1.51
Marine Loading - Ships/Ocean Barges	0.28
Marine Loading - Barges	0.45

Notes:

¹ API Compendium of Greenhouse Gas Emissions Methodologies for the Oil and Gas Industry, Table 5-12.

² Maximum lb/hr based on average hourly truck loading rate. Average lb/hr based on TPY conversion assuming continuous operation.

³ CO₂e = CO₂ equivalent (Pollutant times GWP multiplier):

40 CFR 98 Table A-1, Global Warming Potential (GWP) multiplier: CO₂ = 1, CH₄ = 25

**SWN Production Company, LLC
 Robert Bone Pad
 Vapor Combustor Emissions Calculations - Criteria and Hazardous Air Pollutants**

Criteria and Hazardous Air Pollutant Emissions

Unit ID	Pollutant	Emission Factors ¹	Total Captured Emissions ²		Combustor Destruction Efficiency	Total Controlled Emissions (Post-Capture and Combustion)	
			lb/hr	TPY		lb/hr	TPY
APC-COMB	NOx	0.138	-	-	-	3.31	14.51
	CO	0.2755	-	-	-	6.61	28.96
	PM	7.6	-	-	-	0.07	0.30
	VOC	Mass Balance	256.00	1,121.28	98.00%	5.12	22.43
	n-Hexane	Mass Balance	13.22	57.90	98.00%	0.26	1.16
	Benzene	Mass Balance	0.17	0.73	98.00%	<0.01	0.01
	Toluene	Mass Balance	0.80	3.50	98.00%	0.02	0.07
	Ethylbenzene	Mass Balance	0.96	4.21	98.00%	0.02	0.08
	Xylenes	Mass Balance	1.39	6.11	98.00%	0.03	0.12

Notes:

¹ Although a vapor combustor is not considered a flare by design, the function is consistent in that it combusts a waste stream for the purpose of reducing emissions; therefore, flare emission factors for NOx and CO were used to provide the most accurate emissions estimates. Although the combustor is designed to be smokeless, PM emissions have been estimated using AP-42 Table 1.4-1 factor (lb/mmscf) for a conservative estimate.

Hours per Year:	8,760
Number of Combustors:	1
Max. Incinerator Capacity:	226.50 lb/hr
	24.0 mmBtu/hr per Combustor
	24.0 mmBtu/hr Total Heat Input

NOx and CO emission factors (lb/mmBtu): *TCEQ Air Permit Technical Guidance for Chemical Sources: Flares and Vapor Oxidizers*: High Btu waste streams (>1,000 Btu/scf) based on heat input to each combustor =

² Total captured emissions are based on 100% capture efficiency from storage tanks and 70% capture efficiency from condensate truck loading with 98% destruction efficiency from the vapor combustor based on 8,760 hours of operation per year. Captured emissions from sources controlled by VOC combustor shown in following tables.

SWN Production Company, LLC
Robert Bone Pad
Vapor Combustor Emissions Calculations - Criteria and Hazardous Air Pollutants (Continued)

Source	Captured VOC Emissions	
	lb/hr	TPY
Condensate Storage Tanks	236.40	1,035.42
Produced Water Storage Tanks	2.40	10.53
Condensate Truck Loading	17.20	75.33
Total VOC =	256.00	1,121.28

Source	Captured HAP Emissions (lb/hr)				
	n-Hexane	Benzene	Toluene	Ethylbenzene	Xylenes
Condensate Storage Tanks	12.21	0.15	0.74	0.89	1.29
Produced Water Storage Tanks	0.12	<0.01	0.01	0.01	0.01
Condensate Truck Loading	0.89	0.01	0.05	0.06	0.09
Total HAP =	13.22	0.17	0.80	0.96	1.39

Source	Captured HAP Emissions (TPY)				
	n-Hexane	Benzene	Toluene	Ethylbenzene	Xylenes
Condensate Storage Tanks	53.46	0.68	3.23	3.88	5.64
Produced Water Storage Tanks	0.54	0.01	0.03	0.04	0.06
Condensate Truck Loading	3.89	0.05	0.23	0.28	0.41
Total HAP =	57.90	0.73	3.50	4.21	6.11

**SWN Production Company, LLC
 Robert Bone Pad
 Vapor Combustor Emissions Calculations - Greenhouse Gases**

Equipment Information

Unit ID:	<u>APC-COMB</u>
Description:	Vapor Combustor
Number of Combustors:	1
Burner Design Capacity (mmBtu/hr):	24.0
Stream HHV (Btu/scf):	2,682
Annual Throughput (mmscf):	78.39
Annual Operating Hours:	8,760

Greenhouse Gas (GHG) Emissions

Pollutant	lb/hr	tonnes/yr	tons/yr
CO ₂	2,807.45	11,155.31	12,296.63
CH ₄	0.05	0.21	0.23
N ₂ O	0.01	0.02	0.02
CH ₄ as CO ₂ e	1.32	5.26	5.79
N ₂ O as CO ₂ e	1.58	6.27	6.91
Total CO₂ + CO₂e =	2,810.35	11,166.83	12,309.33

40 CFR 98 Tables C-1 and C-2 Emission Factors (kg/mmBtu)¹

Carbon Dioxide (CO ₂)	53.06
Methane (CH ₄)	1.00E-03
Nitrous Oxide (N ₂ O)	1.00E-04

Notes:

¹ CO₂e = CO₂ equivalent (Pollutant times GWP multiplier):

40 CFR 98 Table A-1, Global Warming Potential (GWP) multiplier: CO₂ = 1, CH₄ = 25, N₂O = 298

**SWN Production Company, LLC
 Robert Bone Pad
 Vapor Combustor Pilot Emissions Calculations - Criteria Air Pollutants**

Criteria Air Pollutant Emissions

Unit ID	Pollutant	Emission Factors ¹	Emissions	
		(lb/mmscf)	lb/hr	TPY
EU-PILOTS APC-COMB	NOx	100	0.02	0.09
	CO	84	0.02	0.07
	VOC	5.5	<0.01	<0.01
	SO ₂	0.6	<0.01	<0.01
	PM	7.6	<0.01	0.01

905 Pilot Stream Heat Content (Btu/SCF)
 8,760 Pilot Hours/Yr
 200 Total Pilot Gas Flow Rate (SCFH)²
 181,000 Total Pilot Gas Fuel Use (Btu/hr)
 1.75 Total Annual Fuel Use (MMSCF)

Notes:

¹ AP-42 Table 1.4-1, -2 (7/98)

² Vapor Combustor is equipped with four(4) pilots with a pilot fuel consumption of 50 SCFH per pilot.

**SWN Production Company, LLC
 Robert Bone Pad
 Vapor Combustor Pilot Emissions Calculations - Hazardous Air Pollutants**

Hazardous Air Pollutant Emissions

Unit ID	Pollutant	Emission Factors ¹	Emissions	
		(lb/mmscf)	lb/hr	TPY
EU-PILOTS APC-COMB	n-Hexane	1.8	<0.01	<0.01
	Formaldehyde	0.075	<0.01	<0.01
	Benzene	0.0021	<0.01	<0.01
	Toluene	0.0034	<0.01	<0.01
Total HAP =			<0.01	<0.01

905 Pilot Stream Heat Content (Btu/SCF)
 8,760 Pilot Hours/Yr
 200 Total Pilot Gas Flow Rate (SCFH)²
 181,000 Total Pilot Gas Fuel Use (Btu/hr)
 1.75 Total Annual Fuel Use (MMSCF)

Notes:

¹ AP-42 Table 1.4-3 (7/98)

² Vapor Combustor is equipped with four (4) pilots with a pilot fuel consumption of 50 SCFH per pilot.

**SWN Production Company, LLC
 Robert Bone Pad
 Vapor Combustor Pilot Emissions Calculations - Greenhouse Gases**

Greenhouse Gas (GHG) Emissions

Unit ID	Pollutant	Emissions		
		lb/hr	tonnes/yr	tons/yr
EU-PILOTS APC-COMB	CO ₂	21.17	84.13	92.74
	CH ₄	<0.01	<0.01	<0.01
	N ₂ O	<0.01	<0.01	<0.01
	CH ₄ as CO ₂ e	0.01	0.04	0.04
	N ₂ O as CO ₂ e	0.01	0.05	0.05
Total CO₂ + CO₂e =		21.19	84.22	92.83

905 Pilot Stream Heat Content (Btu/SCF)
 8,760 Pilot Hours/Yr
 200 Total Pilot Gas Flow Rate (SCFH)²
 181,000 Total Pilot Gas Fuel Use (Btu/hr)
 1.75 Total Annual Fuel Use (MMSCF)

40 CFR 98 Tables C-1 and C-2 Emission Factors (kg/mmBtu)¹

Carbon Dioxide (CO ₂)	53.06
Methane (CH ₄)	1.00E-03
Nitrous Oxide (N ₂ O)	1.00E-04

Notes:

¹ CO₂e = CO₂ equivalent (Pollutant times GWP multiplier):

40 CFR 98 Table A-1, Global Warming Potential (GWP) multiplier: CO₂ = 1, CH₄ = 25, N₂O = 298

² Vapor Combustor is equipped with four (4) pilots with a pilot fuel consumption of 50 SCFH per pilot.

SWN Production Company, LLC
 Robert Bone Pad
 Fugitive Emissions Calculations - Criteria and Hazardous Air Pollutants and Greenhouse Gases

Equipment Information

Source Type/Service	Number of Sources ¹	Em. Factor (lb/hr/source) ²	Control Efficiency	TOC lb/hr	TOC TPY	VOC Wt %
Valves - Gas	79	9.92E-03	0.00%	0.78	3.43	23.15%
Flanges - Gas	363	8.60E-04	0.00%	0.31	1.37	23.15%
Compressor Seals - Gas	9	1.94E-02	0.00%	0.17	0.76	23.15%
Relief Valves - Gas	58	1.94E-02	0.00%	1.13	4.93	23.15%
Total TOC (Gas Components) =				2.40	10.49	-
Valves - Light Oil	178	5.51E-03	0.00%	0.98	4.30	95.45%
Flanges - Light Oil	42	2.43E-04	0.00%	0.01	0.04	95.45%
Connectors - Light Oil	622	4.63E-04	0.00%	0.29	1.26	95.45%
Other - Light Oil	7	1.65E-02	0.00%	0.12	0.51	95.45%
Total TOC (Liquid Components) =				1.39	6.11	-

VOC and Greenhouse Gas Emissions

Source Type/Service	VOC		CH ₄		CO ₂	
	lb/hr	TPY	lb/hr	TPY	lb/hr	TPY
Valves - Gas	0.18	0.79	0.41	1.77	<0.01	0.01
Flanges - Gas	0.07	0.32	0.16	0.71	<0.01	<0.01
Compressor Seals - Gas	0.04	0.18	0.09	0.40	<0.01	<0.01
Relief Valves - Gas	0.26	1.14	0.58	2.55	<0.01	0.01
Components in Gas Service =	0.55	2.43	1.24	5.42	0.01	0.03
Valves - Light Oil	0.94	4.10	0.01	0.04	<0.01	<0.01
Flanges - Light Oil	0.01	0.04	<0.01	<0.01	<0.01	<0.01
Connectors - Light Oil	0.27	1.20	<0.01	0.01	<0.01	<0.01
Other - Light Oil	0.11	0.48	<0.01	0.01	<0.01	<0.01
Components in Liquid Service =	1.33	5.83	0.01	0.06	<0.01	<0.01
Total (Gas + Liquid Components) =	1.89	8.26	1.25	5.49	0.01	0.03

SWN Production Company, LLC
 Robert Bone Pad
 Fugitive Emissions Calculations (Continued)

Hazardous Air Pollutant (HAP) Emissions (lb/hr)

Source Type/Service	n-Hexane	Benzene	Toluene	Ethylbenzene	Xylenes	2,2,4-Tri.	Total
Valves - Gas	<0.01	<0.01	<0.01	0.00	<0.01	0.00	<0.01
Flanges - Gas	<0.01	<0.01	<0.01	0.00	<0.01	0.00	<0.01
Compressor Seals - Gas	<0.01	<0.01	<0.01	0.00	<0.01	0.00	<0.01
Relief Valves - Gas	<0.01	<0.01	<0.01	0.00	<0.01	0.00	<0.01
Components in Gas Service =	0.01	<0.01	<0.01	0.00	<0.01	0.00	0.01
Valves - Light Oil	0.05	<0.01	<0.01	<0.01	0.01	0.00	0.06
Flanges - Light Oil	<0.01	<0.01	<0.01	<0.01	<0.01	0.00	<0.01
Connectors - Light Oil	0.01	<0.01	<0.01	<0.01	<0.01	0.00	0.02
Other - Light Oil	0.01	<0.01	<0.01	<0.01	<0.01	0.00	0.01
Components in Liquid Service =	0.07	<0.01	<0.01	0.01	0.01	0.00	0.09
Total (Gas + Liquid Components) =	0.08	<0.01	<0.01	0.01	0.01	0.00	0.10

Hazardous Air Pollutant (HAP) Emissions (TPY)

Source Type/Service	n-Hexane	Benzene	Toluene	Ethylbenzene	Xylenes	2,2,4-Tri.	Total
Valves - Gas	0.01	<0.01	<0.01	0.00	<0.01	0.00	0.01
Flanges - Gas	<0.01	<0.01	<0.01	0.00	<0.01	0.00	<0.01
Compressor Seals - Gas	<0.01	<0.01	<0.01	0.00	<0.01	0.00	<0.01
Relief Valves - Gas	0.01	<0.01	<0.01	0.00	<0.01	0.00	0.01
Components in Gas Service =	0.03	<0.01	<0.01	0.00	<0.01	0.00	0.03
Valves - Light Oil	0.22	<0.01	0.01	0.02	0.02	0.00	0.28
Flanges - Light Oil	<0.01	<0.01	<0.01	<0.01	<0.01	0.00	<0.01
Connectors - Light Oil	0.07	<0.01	<0.01	<0.01	0.01	0.00	0.08
Other - Light Oil	0.03	<0.01	<0.01	<0.01	<0.01	0.00	0.03
Components in Liquid Service =	0.32	<0.01	0.02	0.02	0.03	0.00	0.39
Total (Gas + Liquid Components) =	0.34	<0.01	0.02	0.02	0.03	0.00	0.42

SWN Production Company, LLC
 Robert Bone Pad
 Fugitive Emissions Calculations (Continued)

Typical Component Count per Equipment Type based on Representative Facility³

Source Type/Service	WH	GPU	HT	LPT	FGC	TK	TT-O	SP
Valves - Gas	12	3	2	5	5	0	0	0
Flanges - Gas	37	15	9	24	33	3	2	0
Compressor Seals - Gas	0	0	0	0	3	0	0	0
Relief Valves - Gas	1	3	1	1	1	3	1	0
Open-Ended Lines - Gas	0	0	0	0	0	0	0	0
Valves - Light Oil	0	5	6	12	3	6	9	8
Flanges - Light Oil	0	0	0	0	0	0	0	6
Connectors - Light Oil	0	20	24	48	12	24	30	20
Pump Seals - Light Oil	0	0	0	0	0	0	0	0
Other - Light Oil	0	0	0	0	0	0	0	1

Equipment Type	WH	GPU	HT	LPT	FGC	TK	TT-O	SP
Number of Each Type On Pad =	4	4	2	0	3	12	1	7

SWN Production Company, LLC
 Robert Bone Pad
 Fugitive Emissions Calculations (Continued)

Speciated Gas Analysis⁴

Component	Molecular Weight	Mole %	Equiv. Wt. Basis	Weight %	HC Weight %	Ib/hr	TPY
Hydrogen Sulfide	34.082	0.000%	0.000	0.000%	-	0.00	0.00
Carbon Dioxide	44.010	0.133%	0.059	0.264%	-	0.01	0.03
Nitrogen	28.013	0.496%	0.139	0.627%	-	0.02	0.07
Methane	16.042	70.754%	11.350	51.223%	51.683%	1.24	5.42
Ethane	30.069	18.380%	5.527	24.941%	25.165%	0.60	2.64
Propane	44.096	7.198%	3.174	14.324%	14.453%	0.35	1.52
i-Butane	58.122	0.590%	0.343	1.548%	1.561%	0.04	0.16
n-Butane	58.122	1.711%	0.994	4.488%	4.528%	0.11	0.48
i-Pentane	72.149	0.214%	0.154	0.697%	0.703%	0.02	0.07
n-Pentane	72.149	0.317%	0.229	1.032%	1.041%	0.02	0.11
n-Hexane	86.175	0.067%	0.058	0.261%	0.263%	0.01	0.03
Other Hexanes	86.175	0.080%	0.069	0.311%	0.314%	0.01	0.03
Heptanes (as n-Heptane)	100.202	0.041%	0.041	0.185%	0.187%	<0.01	0.02
Benzene	78.114	0.001%	0.001	0.004%	0.004%	<0.01	<0.01
Toluene	92.141	0.001%	0.001	0.004%	0.004%	<0.01	<0.01
Ethylbenzene	106.167	0.000%	0.000	0.000%	0.000%	0.00	0.00
Xylenes	106.167	0.001%	0.001	0.005%	0.005%	<0.01	<0.01
2,2,4-Trimethylpentane	114.230	0.000%	0.000	0.000%	0.000%	0.00	0.00
Octanes (as n-Octane)	114.229	0.011%	0.013	0.057%	0.057%	<0.01	0.01
Nonanes (as n-Nonane)	128.255	0.003%	0.004	0.017%	0.018%	<0.01	<0.01
Decanes (as n-Decane)	142.282	0.002%	0.003	0.013%	0.013%	<0.01	<0.01
TOTAL =		100.00%	22.16	100.00%	100.00%	2.42	10.59
		TOTAL HC =	21.96	TOTAL VOC =	23.15%	0.55	2.43
				TOTAL HAP =	0.28%	0.01	0.03

SWN Production Company, LLC
 Robert Bone Pad
 Fugitive Emissions Calculations (Continued)

Speciated Liquids Analysis⁴

Component	Molecular Weight	Mole %	Equiv. Wt. Basis	Weight %	HC Weight %	Ib/hr	TPY
Hydrogen Sulfide	34.082	0.000%	0.000	0.000%	-	0.00	0.00
Carbon Dioxide	44.010	0.010%	0.004	0.005%	-	<0.01	<0.01
Nitrogen	28.013	0.015%	0.004	0.005%	-	<0.01	<0.01
Methane	16.042	5.084%	0.816	1.018%	1.018%	0.01	0.06
Ethane	30.069	9.419%	2.832	3.536%	3.536%	0.05	0.22
Propane	44.096	13.438%	5.926	7.398%	7.398%	0.10	0.45
i-Butane	58.122	2.701%	1.570	1.960%	1.960%	0.03	0.12
n-Butane	58.122	11.641%	6.766	8.447%	8.448%	0.12	0.52
i-Pentane	72.149	3.950%	2.850	3.558%	3.558%	0.05	0.22
n-Pentane	72.149	7.673%	5.536	6.911%	6.912%	0.10	0.42
n-Hexane	86.175	4.799%	4.136	5.163%	5.163%	0.07	0.32
Other Hexanes	86.175	4.886%	4.211	5.256%	5.257%	0.07	0.32
Heptanes (as n-Heptane)	100.202	8.310%	8.327	10.395%	10.396%	0.15	0.64
Benzene	78.114	0.067%	0.052	0.065%	0.065%	<0.01	<0.01
Toluene	92.141	0.271%	0.250	0.312%	0.312%	<0.01	0.02
Ethylbenzene	106.167	0.283%	0.300	0.375%	0.375%	0.01	0.02
Xylenes	106.167	0.411%	0.436	0.545%	0.545%	0.01	0.03
2,2,4-Trimethylpentane	114.230	0.000%	0.000	0.000%	0.000%	0.00	0.00
Octanes (as n-Octane)	114.229	6.334%	7.235	9.033%	9.034%	0.13	0.55
Nonanes (as n-Nonane)	128.255	4.366%	5.600	6.991%	6.991%	0.10	0.43
Decanes (as n-Decane)	142.282	16.342%	23.252	29.028%	29.031%	0.40	1.77
TOTAL =		100.00%	80.10	100.00%	100.00%	1.40	6.11
		TOTAL HC =	80.09	TOTAL VOC =	95.45%	1.33	5.83
				TOTAL HAP =	6.46%	0.09	0.39

Notes:

¹ Component counts taken by equipment type at representative facility and made site-specific according to the number of each equipment type at this site.

² Emission Factor Source: EPA-453/R-95-017. TOC multiplied by pollutant content of streams (weight %) to obtain pollutant emissions.

³ Equipment Type Key: WH = Well Head, GPU = Gas Production Unit, HT = Heater, LPT = Low-Pressure Tower, FGC = Flash Gas Compressor, TK = Storage Tank, TT-O = Tank Truck - Oil SP = Separator

⁴ Gas and liquids analyses located in Attachment L.

**SWN Production Company, LLC
Robert Bone Pad
Fugitive Haul Road Emissions**

Facility Data ¹

Vehicle Type	Light Vehicles (Pick-ups and Cars)	Medium Trucks (Service Trucks)	Heavy Trucks (Tanker Trucks) ²
Average vehicle weight ((empty + full)/2) (tons)	2	15	23.5
Number of wheels per vehicle type (w)	4	10	18
Average number of round trips/day/vehicle type	9	5	19
Distance per round trip (miles/trip)	1.54	1.54	1.54
Vehicle miles travelled (miles/day)	14.47	7.24	28.95
Number of days operational (days/yr)	365	365	365
Vehicle miles travelled VMT (miles/yr)	5,283	2,642	10,566
Average vehicle speed S (mph)	10	10	10
Average number of round trips/hour/vehicle type	0.52	0.26	1.05
Average number of round trips/year/vehicle type	3,433	1,717	6,867
Estimated maximum number of round trips/hour/vehicle type	3	3	2
Estimated maximum number of round trips/day/vehicle type	6	4	21
Estimated maximum number of round trips/year/vehicle type	2,300	1,533	7,976

190 Average Tanker Volume (bbl)
7,980 Gallons Tanker Volume
1,793 bwpd
1,781 bopd
18.81 Tanker Trucks per Day
3,722 Length Leased Access Road (ft)
340 Longest Pad Side (ft)
8,125 Total Round Trip Feet

Formula & Calculation Inputs

$$E = k(s/12)^a * (W/3)^b * ((365-P) / 365)$$

where:

Days per year
Annual average hours per day of road operations
k = PM Particle Size Multiplier
k = PM10 Particle Size Multiplier
k = PM2.5 Particle Size Multiplier
s = Surface Material Silt Content
P = Number of days > 0.01 inch of rain
a = PM Constant
a = PM10 & PM2.5 Constant
b = PM, PM10, & PM2.5 Constant
Total hourly fleet vehicle miles travelled (miles/hr)
Total annual fleet vehicle miles travelled (miles/yr)³
Average wheels⁴
Average vehicle weight of the fleet (W)⁵
Moisture Ratio
Control Efficiency (CF)

Reference : AP-42, Section 13.2.2 (11/06), Equation 1a and 2

Rate	Units	Comment
365		
18		
4.90	lb/VMT	AP-42 Section 13.2.2 (11/06), Table 13.2.2-2 (PM)
1.50	lb/VMT	AP-42 Section 13.2.2 (11/06), Table 13.2.2-2 (PM ₁₀)
0.15	lb/VMT	AP-42 Section 13.2.2 (11/06), Table 13.2.2-2 (PM _{2.5})
3.9	%	State Default Data from AP-42 Data (1999 NEI Data)
150	days/year	AP-42 Section 13.2.2 (11/06), Figure 13.2.2-1
0.70	unitless	AP-42 Section 13.2.2 (11/06), Table 13.2.2-2 (PM)
0.90	unitless	AP-42 Section 13.2.2 (11/06), Table 13.2.2-2 (PM ₁₀ & PM _{2.5})
0.45	unitless	AP-42 Section 13.2.2 (11/06), Table 13.2.2-2
2.81	VMT/hr	
18,490.81	VMT/yr	
13		
16.1	tons	
1.00		Estimated based on 0.2% uncontrolled surface water content assuming no watering
0.00	%	Based on Moisture Ratio and Figure 13.2.2-2 Control

EPA - BID Document 13.2.2 - 1998

SWN Production Company, LLC
 Robert Bone Pad
 Fugitive Haul Road Emissions (Continued)

Vehicle Type	Emission Factors			Control Efficiency (%)	Total Vehicle Miles Travelled		Emission Rates			Emission Rates		
	PM	PM ₁₀	PM _{2.5}		(VMT/hr)	(VMT/yr)	Total PM	Total PM ₁₀	PM _{2.5}	Total PM	Total PM ₁₀	PM _{2.5}
	(lbs/VMT)	(lbs/VMT)	(lbs/VMT)				(lb/hr)	(lb/hr)	(lb/hr)	(tons/yr)	(tons/yr)	(tons/yr)
Light Vehicles	2.80	0.69	0.07	0.00	0.80	5,283.09	2.25	0.55	0.06	7.40	1.81	0.18
Medium Trucks	2.80	0.69	0.07	0.00	0.40	2,641.54	1.13	0.28	0.03	3.70	0.90	0.09
Heavy Trucks	2.80	0.69	0.07	0.00	1.61	10,566.18	4.51	1.10	0.11	14.81	3.62	0.36
Total =				0.00	2.81	18,490.81	7.89	1.93	0.19	25.91	6.33	0.63

Notes:

- 1) Facility vehicle data based on estimates, GP5.1 and AP-42 13.2.2-2 defaults for industrial unpaved roads
- 2) Tank trucker average vehicle weight as $(W_{(empty)} + W_{(full)})/2 = (7 + 40)/2 = 23.7$ tons
- 3) Average vehicle miles travelled (VMT/yr) as (No. of round trip/vehicle * No. of vehicles/type * Roundtrip miles/trip) * 365 days/yr * No. of vehicle type)
- 4) Average wheels calculated as average of (No. of wheels per vehicle type * No. of vehicle/type)
- 5) Average vehicle fleet calculated as (Average weight of vehicle type * Percentage of each vehicle type on unpaved surface). Percentage of each vehicle type = $VMT_{vehicle\ type} / VMT$
- 6) Minimum one-per-day average pick-up trucks and service trucks even if tanker not required every day.
- 7) Per EPA BID calculations, all emissions based on average trips. Estimated maximum hourly, daily and yearly trips provided for information only.

Calculation of Emission Factors (AP-42, 13.2.2)

Equation 1a: $EF = k(s/12)^a (W/3)^b$ where *k*, *a*, and *b* are empirical constants and
EF = size-specific emission factor (lb/VMT)
s = surface material silt content %
W = mean vehicle weight (tons)

Equation 2: $EF_{ext} = EF * ((365 - P) / 365)$ where:
EF_{ext} = annual size-specific emission factor extrapolated for natural mitigation, lb/VMT
EF = emission factor from Equation 1a
P = number of days in a year with at least 0.01 inches of precipitation

Calculation of Emissions

$E = EF_{ext} * VMT/yr * ((1 - CF) / 100) * 1 \text{ ton} / 2000 \text{ lbs}$ where:
E = annual emissions (tons/yr)
EF_{ext} = annual size-specific emission factor extrapolated for natural mitigation, lb/VMT
CF = control efficiency (%)

ATTACHMENT U: FACILITY-WIDE EMISSION SUMMARY SHEETS

ATTACHMENT U – FACILITY-WIDE CONTROLLED EMISSIONS SUMMARY SHEET

List all sources of emissions in this table. Use extra pages if necessary.

Emission Point ID #	NO _x		CO		VOC		SO ₂		PM ₁₀		PM _{2.5}		CH ₄		GHG (CO ₂ e)	
	lb/hr	tpy	lb/hr	tpy	lb/hr	tpy	lb/hr	tpy	lb/hr	tpy	lb/hr	tpy	lb/hr	tpy	lb/hr	tpy
EP-ENG1	0.32	1.40	0.64	2.80	0.16	0.69	<0.01	<0.01	0.02	0.11	0.02	0.11	<0.01	0.01	155.19	679.73
EP-ENG2	0.32	1.40	0.64	2.80	0.16	0.69	<0.01	<0.01	0.02	0.11	0.02	0.11	<0.01	0.01	155.19	679.73
EP-ENG3	0.45	1.96	0.90	3.92	0.23	1.00	<0.01	<0.01	0.04	0.16	0.04	0.16	<0.01	0.02	217.27	951.66
EP-GPU1	0.11	0.48	0.09	0.41	0.01	0.03	<0.01	<0.01	0.01	0.04	0.01	0.04	<0.01	0.01	117.10	512.89
EP-GPU2	0.11	0.48	0.09	0.41	0.01	0.03	<0.01	<0.01	0.01	0.04	0.01	0.04	<0.01	0.01	117.10	512.89
EP-GPU3	0.11	0.48	0.09	0.41	0.01	0.03	<0.01	<0.01	0.01	0.04	0.01	0.04	<0.01	0.01	117.10	512.89
EP-GPU4	0.11	0.48	0.09	0.41	0.01	0.03	<0.01	<0.01	0.01	0.04	0.01	0.04	<0.01	0.01	117.10	512.89
EP-SH1	0.17	0.73	0.14	0.61	0.01	0.04	<0.01	<0.01	0.01	0.06	0.01	0.06	<0.01	0.01	175.65	769.33
EP-SH2	0.17	0.73	0.14	0.61	0.01	0.04	<0.01	<0.01	0.01	0.06	0.01	0.06	<0.01	0.01	175.65	769.33
EP-LOAD-COND	-	-	-	-	7.37	32.28	-	-	-	-	-	-	0.96	4.21	24.03	105.25
EP-LOAD-PW	-	-	-	-	0.09	0.39	-	-	-	-	-	-	3.22	14.12	80.63	353.17
APC-COMB	3.33	14.59	6.63	29.03	5.12	22.43	<0.01	<0.01	0.07	0.30	0.07	0.30	0.05	0.23	2,831.55	12,402.16
TOTAL	5.19	22.74	9.45	41.40	13.17	57.66	0.01	0.03	0.21	0.93	0.21	0.93	4.26	18.68	4,283.54	18,761.91

Annual emissions shall be based on 8,760 hours per year of operation for all emission units except emergency generators.

According to 45CSR14 Section 2.43.e, fugitive emissions are not included in the major source determination because it is not listed as one of the source categories in Table 1. Therefore, fugitive emissions shall not be included in the PTE above.

Note that the emissions from the APC-COMB includes uncombusted emissions from the storage tanks and condensate loading operations, as well as combustor pilot emissions.

ATTACHMENT U – FACILITY-WIDE HAP CONTROLLED EMISSIONS SUMMARY SHEET

List all sources of emissions in this table. Use extra pages if necessary.

Emission Point ID #	Formaldehyde		Benzene		Toluene		Ethylbenzene		Xylenes		Hexane		Total HAPs		
	lb/hr	tpy	lb/hr	tpy	lb/hr	tpy	lb/hr	tpy	lb/hr	tpy	lb/hr	tpy	lb/hr	tpy	
EP-ENG1	0.09	0.38	<0.01	0.01	<0.01	<0.01	<0.01	<0.01	<0.01	<0.01	<0.01	-	-	0.10	0.44
EP-ENG2	0.09	0.38	<0.01	0.01	<0.01	<0.01	<0.01	<0.01	<0.01	<0.01	<0.01	-	-	0.10	0.44
EP-ENG3	0.12	0.53	<0.01	0.01	<0.01	<0.01	<0.01	<0.01	<0.01	<0.01	<0.01	-	-	0.14	0.62
EP-GPU1	<0.01	<0.01	<0.01	<0.01	<0.01	<0.01	-	-	-	-	<0.01	0.01	<0.01	0.01	
EP-GPU2	<0.01	<0.01	<0.01	<0.01	<0.01	<0.01	-	-	-	-	<0.01	0.01	<0.01	0.01	
EP-GPU3	<0.01	<0.01	<0.01	<0.01	<0.01	<0.01	-	-	-	-	<0.01	0.01	<0.01	0.01	
EP-GPU4	<0.01	<0.01	<0.01	<0.01	<0.01	<0.01	-	-	-	-	<0.01	0.01	<0.01	0.01	
EP-SH1	<0.01	<0.01	<0.01	<0.01	<0.01	<0.01	-	-	-	-	<0.01	0.01	<0.01	0.01	
EP-SH2	<0.01	<0.01	<0.01	<0.01	<0.01	<0.01	-	-	-	-	<0.01	0.01	<0.01	0.01	
EP-LOAD-COND	-	-	<0.01	0.02	0.02	0.10	0.03	0.12	0.04	0.18	0.38	1.67	0.48	2.09	
EP-LOAD-PW	-	-	<0.01	<0.01	<0.01	<0.01	<0.01	<0.01	<0.01	<0.01	<0.01	0.02	0.01	0.03	
APC-COMB	<0.01	<0.01	<0.01	0.01	0.02	0.07	0.02	0.08	0.03	0.12	0.26	1.16	0.33	1.45	
TOTAL	0.29	1.29	0.02	0.07	0.04	0.18	0.05	0.21	0.07	0.30	0.66	2.91	1.17	5.12	

Annual emissions shall be based on 8,760 hours per year of operation for all emission units except emergency generators.

According to 45CSR14 Section 2.43.e, fugitive emissions are not included in the major source determination because it is not listed as one of the source categories in Table 1. Therefore, fugitive emissions shall not be included in the PTE above.

Note that the emissions from the APC-COMB includes uncombusted emissions from the storage tanks and condensate loading operations, as well as combustor pilot emissions.

ATTACHMENT V: LEGAL ADVERTISEMENT

Note: Affidavit of Publication will be submitted upon receipt by SWN from the publisher.

AIR QUALITY PERMIT NOTICE Notice of Application

Notice is given that SWN Production Company, LLC has applied to the West Virginia Department of Environmental Protection, Division of Air Quality, for a G70-D General Permit Registration for a natural gas production facility (Robert Bone Pad) located in Brooke County, West Virginia. Travel north on SR 2 from Wheeling, WV to just south of the community of Wellsburg, WV. Turn right onto CR 67 (Bethany Pike) south of Wellsburg and travel east 4.5 miles to CR 30 (Hukill Run road). Turn right onto CR 30 and travel approximately 0.7 miles to access road on the right. Latitude and longitude coordinates are: 40.218919, -80.601742.

The applicant estimates the potential to discharge the following Regulated Air Pollutants will be:

Nitrogen Oxides (NO _x)	22.74 tons/yr
Carbon Monoxide (CO)	41.40 tons/yr
Volatile Organic Compounds (VOC)	57.66 tons/yr
Sulfur Dioxide (SO ₂)	0.03 tons/yr
Particulate Matter (PM)	0.93 tons/yr
Acetaldehyde	0.05 tons/yr
Acrolein	0.05 tons/yr
Benzene	0.07 tons/yr
Ethylbenzene	0.23 tons/yr
Formaldehyde	1.29 tons/yr
Methanol	0.06 tons/yr
n-Hexane	3.25 tons/yr
Toluene	0.20 tons/yr
Xylenes	0.34 tons/yr
Carbon Dioxide	18,284.82 tons/yr
Methane	24.16 tons/yr
Nitrous Oxide	0.03 tons/yr
CO ₂ Equivalent	18,899.07 tons/yr

Operations is planned to begin on or about May 1, 2018. Written comments will be received by the West Virginia Department of Environmental Protection, Division of Air Quality, 601 57th Street, SE, Charleston, WV 25304, for at least 30 calendar days from the date of publication of this notice. Any questions regarding this permit application should be directed to the DAQ at (304) 926-0499, extension 1250, during normal business hours.

Dated this the XXth of December 2017

SWN Production Company, LLC
Robert Bone Pad
December 2017

By: SWN Production Company, LLC
Clay Murrall
Regulatory Supervisor
179 Innovation Drive
Jane Lew, WV 26378